

BIG WHITE[®]

SLV LIGHTING CATALOGUE 2024













RESTEZ INFORMÉ

Scannez le QR code et sélectionnez votre pays pour avoir accès à nos prix mis à jour.
Rendez-nous visite sur notre site **slv.com**

FAMILLES À L'HONNEUR

NUMINOS®	82
NEW TRIA®	122
MEDO®	148
LALU®	176
ONE®	186

INTÉRIEUR

 Encastrés	202
 Plafonniers	248
 Suspensions	278
 Appliques	320
 Appliques et plafonniers	390
 Lampes à poser et lampadaires	434
 Système 48 V	454
 Système de câble tendu T.B.T.	480
 Rail 230 V 1 allumage	492
 Rail 230 V 3 allumages	524
 Solutions de profils et bandeaux LED	564

EXTÉRIEUR

 Luminaires mobiles et bornes	594
 Projecteurs	686
 Appliques	704
 Plafonniers	786
 Appliques et plafonniers	802
 Encastrés	818
 Encastrés de sol	828

SOURCES ET ACCESSOIRES

 Sources	858
 Accessoires	866

NAVIGATION

Éditorial et références	4
Index applications	14
Index familles	46
Index numérique	882
Index alphabétique	892

NOUVELLE NAVIGATION

APERÇU PAR CATÉGORIE

D'un seul coup d'œil. Trouvez le luminaire idéal en parcourant sa catégorie.

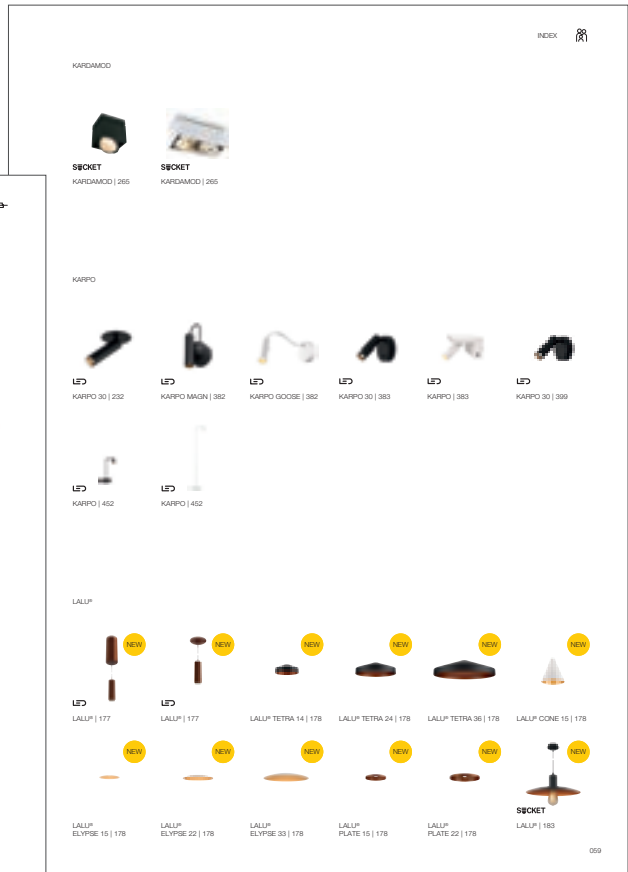

APERÇU PAR FAMILLE

Découvrez tous les luminaires d'une même famille pour un concept d'éclairage cohérent.

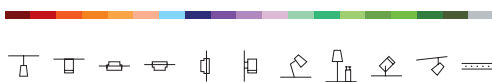

CATÉGORIES DE PRODUITS

S'informer pour bien acheter. Les nouvelles icônes et couleurs utilisées permettent de naviguer facilement dans le catalogue pour trouver rapidement la catégorie recherchée.



RECOMMANDATIONS

Rapide et facile. Découvrez les sources et accessoires adaptés à vos nouveaux produits.

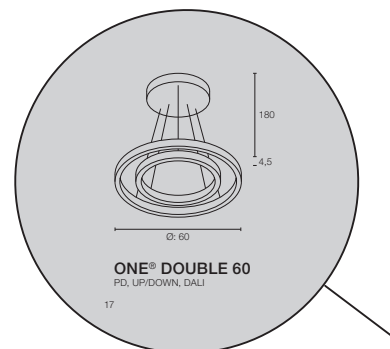

ATTENTION

Toutes nos dimensions sont exprimées en **cm**.

FACILEMENT EXPLIQUÉ

Notre nouvelle rubrique explicative vous donne toutes les informations importantes concernant la lumière et les produits SLV, sous une forme simple et rapide.

Outils d'étude d'éclairage, détails techniques et illustrations de nos systèmes : on vous dit tout dans ce BIG WHITE®. Ne passez donc pas à côté de nos guides pratiques dans les pages jaunes.

CONCEVEZ VOTRE PROFIL LED

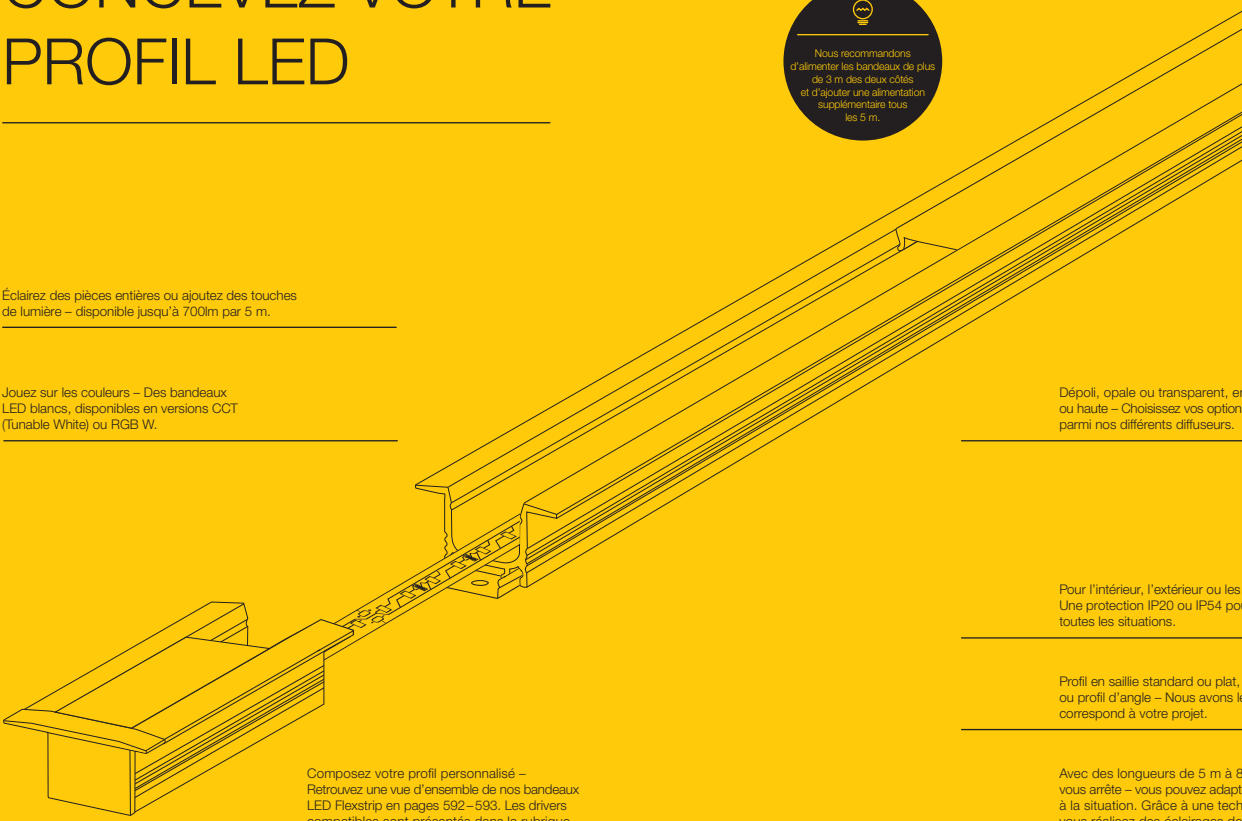

Nous recommandons d'alimenter les bandeaux de plus de 3 m des deux côtés et d'ajouter une alimentation supplémentaire tous les 5 m.

Éclairer des pièces entières ou ajoutez des touches de lumière – disponible jusqu'à 700lm par 5 m.

Jouez sur les couleurs – Des bandeaux LED blancs, disponibles en versions CCT (Tunable White) ou RGB W.

Dépoli, opale ou transparent, en ou haute – Choisissez vos options parmi nos différents diffuseurs.

Pour l'intérieur, l'extérieur ou les p Une protection IP20 ou IP54 pour toutes les situations.

Profil en saillie standard ou plat, p ou profil d'angle – Nous avons le correspond à votre projet.

Avec des longueurs de 5 m à 80 vous arrête – vous pouvez adapter à la situation. Grâce à une techn vous réalisez des éclairages de l importante avec moins de points

Composez votre profil personnalisé – Retrouvez une vue d'ensemble de nos bandeaux LED Flexstrip en pages 592–593. Les drivers compatibles sont présentés dans la rubrique Accessoires en pages 592–593.

580



TOUS LES PRODUITS DIRECTEMENT EN LIGNE

Notre site **slv.com** vous propose l'intégralité des produits SLV avec leurs caractéristiques, leur descriptif, leur disponibilité, etc. Des fichiers de conception, données 3D, configurateurs et autres outils de calcul, tels que FastCalc by DIAL, vous aident à concevoir votre système d'éclairage.

VILLA WALDFEUCHT

UNE MAISON REMPLIE DE LUMINAIRES SLV

Une chaîne Instagram qui accompagne l'aventure d'un jeune couple construisant sa propre maison.

Ils y relatent quotidiennement les raisons pour lesquelles ils ont choisi les luminaires SLV et les obstacles qu'ils ont dû surmonter.



UN CONCEPT D'ÉCLAIRAGE BIEN PENSÉ

Pour l'éclairage de leur villa, les deux jeunes maîtres d'ouvrage avaient à cœur de créer un style uniforme dans toute la maison. La solution alors choisie devait être durablement adaptée à l'utilisation ultérieure – en d'autres termes, offrir une flexibilité maximale.

Les luminaires devaient pouvoir accueillir des ampoules GU10 intelligentes. Par ailleurs, Susanna et Marc souhaitaient un mélange de lumière directe et indirecte qui mette parfaitement en valeur leurs œuvres d'art. Pour toutes ces raisons, ils ont opté pour des rails de marque SLV. Rares sont les autres types d'éclairage à offrir une telle flexibilité : tous les luminaires peuvent être remplacés, ajoutés ou orientés différemment.

Et en matière d'efficacité énergétique, le système de rail est également remarquable : l'éclairage indirect et le contrôle intelligent permettent d'économiser de l'électricité.



Susanna et Marc Mevißen partagent toutes leurs avancées avec leurs abonnés, depuis le premier coup de pioche en 2020 jusqu'à l'achèvement des travaux cette année.

Il est très intéressant de noter qu'en dehors du gros œuvre, ils ont tout fait eux-mêmes. Malgré les travaux de la maison, réalisés après leurs heures de travail, ils ont accordé une attention particulière à l'aspect durable de la construction, à l'efficacité énergétique et à la sophistication du design. Résultat : après seulement 22 mois, la maison était prête pour l'emménagement.

« *NOUS AVONS OPTÉ D'EMBLÉE POUR SLV, CE QUI A GRANDEMENT FACILITÉ LA CONCEPTION DE L'ÉCLAIRAGE.* »

Marc Mevißen, architecte

LE SERVICE ET LA QUALITÉ « SLV »

Si Susanna et Marc ont choisi les luminaires SLV, ce n'est pas par hasard : Marc Mevißen connaissait déjà la marque depuis ses études d'architecture, lorsqu'il devait jouer avec l'ombre et la lumière dans la salle d'exposition.

Au moment de concevoir le système d'éclairage de la maison de leurs rêves, les deux influenceurs ont été particulièrement séduits par le design et le rapport qualité-prix avantageux des rails. À cela s'ajoute la qualité du support technique et la rapidité de service de SLV.





LA LUMIÈRE COMME ŒUVRE D'ART

La salle à manger de la maison de Susanna et Marc occupe un grand volume de 5,65 m de hauteur. Au-dessus de la table, le couple a voulu créer une sorte de sculpture constituée de luminaires. Des rails conducteurs ont été intégrés de façon invisible dans le plafond acoustique pour former une structure de base qui garantissent un maximum de flexibilité. L'équipe SLV a collaboré avec les maîtres d'ouvrage sur site afin de trouver des idées inspirantes et leur présenter un grand nombre de nouveaux luminaires. « C'est le PANTILO de SLV qui nous a le plus séduits en termes de design et de couleur, pour remplir l'espace de façon esthétique, sans éblouir », explique Susanna Mevißen. « Nous adonnons ce reflet dans les luminaires qui complètent notre concept. »

La suspension PANTILO impressionne par son aspect hors du commun : ces abat-jour en verre chromé se combinent facilement pour créer un nuage élégant à une configuration personnalisée. Les sept luminaires PANTILO suspendus au-dessus de la grande table à manger s'harmonisent parfaitement avec le haut plafond en bois, les murs clairs, le sol gris et les châssis de fenêtres noirs de la maison de Susanna et Marc.

*« LES LUMINAIRES NE SONT PAS DE SIMPLES
OBJETS FONCTIONNELS – COMME UNE
ŒUVRE D'ART, ILS ONT AUSSI LA CAPACITÉ
DE DONNER UNE IDENTITÉ À LA PIÈCE. »*

Susanna Mevißen

UNE LUMIÈRE INDIRECTE POUR UNE ATMOSPHÈRE AGRÉABLE

Les plafonds ne sont pas les seuls à être équipés d'éclairages SLV : des luminaires sont également intégrés dans le sol et leur couleur peut être réglée individuellement. Pour toutes les solutions d'éclairage de la maison de leurs rêves, nos deux bâtisseurs misent sur une lumière indirecte et un contrôle intelligent : selon l'intensité lumineuse, certains luminaires indirects éclairent la pièce le soir, plongeant ainsi la maison dans l'atmosphère souhaitée. Cela signifie que pratiquement aucune lumière ne doit être allumée de façon active, ce qui représente un gain d'énergie.



CONSTRUCTION ET ÉCLAIRAGE ÉCOLOGIQUES

Grâce à une isolation bien pensée, un toit plat équipé d'un système photovoltaïque et des matériaux soigneusement sélectionnés comme le béton, le bois, le verre et la pierre naturelle, la maison passive des deux influenceurs Susanna et Marc est un bâtiment à énergie positive répondant à la norme allemande KfW40+. Grâce à l'installation photovoltaïque, ils produisent beaucoup plus d'énergie qu'ils n'en consomment. La maison dispose également d'un système de stockage énergie et d'une borne de recharge pour utiliser l'électricité de manière encore plus efficace.

Cette approche correspond également à notre stratégie de durabilité : en effet, nous nous efforçons de privilégier l'utilisation de matières premières secondaires dans la production de nos solutions d'éclairage, de réduire systématiquement les déchets d'emballage et les émissions dues au transport.

UN PROJET SOLIDE. DES PARTENAIRES SOLIDES

Propriétaires du bâtiment : Susanna et Marc Mevißen

Lieu : Waldfeucht, Rhénanie-du-Nord-Westphalie (Allemagne)
E-mail : mevissen.haus@gmail.com

Concept d'éclairage : les propriétaires en partenariat avec l'équipe de vente de SLV

L'éclairage de la villa de Waldfeucht n'est pas le seul projet réalisé avec la collaboration active de nos experts. Nos partenaires sont présents dans toute l'Europe, avec des projets de toute envergure. Envie d'en savoir plus ? Scannez-moi !

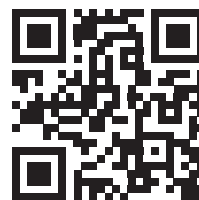

CONNAISSANCES DE L'ÉCLAIRAGE SLV

LUMEN

Le flux lumineux (exprimé en lumens) indique la quantité de lumière émise par une source lumineuse dans toutes les directions. Il représente la luminosité totale perçue par l'œil humain. L'efficacité d'un luminaire est souvent exprimée en lumens par watt. Plus le flux lumineux diffusé est grand (en lumens) par unité de puissance consommée (en watts), plus la source lumineuse est efficace.

IRC

L'indice de rendu des couleurs (Color Rendering Index) représente l'impact d'une source lumineuse sur l'impression que l'être humain se fait de la couleur d'un objet par rapport à une source de lumière naturelle (p. ex. le soleil). Selon la norme EN 12464, les espaces intérieurs dans lesquels des personnes travaillent ou séjournent de façon prolongée doivent présenter un indice de rendu des couleurs (IRC) supérieur à 80.

TEMPÉRATURE DE COULEUR

La température de couleur d'une source lumineuse est indiquée en kelvins (K). Plus elle est élevée, plus la lumière produit un effet froid et stimulant (p. ex. la lumière du jour = 5500 K). Plus le nombre de kelvins est bas, plus la lumière semble chaude et agréable. De nos jours, la température de couleur de l'ampoule à incandescence à 2700 K continue d'être considérée comme parfaite pour l'éclairage des logements. La fonctionnalité additionnelle fournie par un interrupteur CCT permet de paramétrer la température de couleur d'un luminaire.

DIM-TO-WARM (DTW)

La fonction Dim-to-warm permet de régler la température de couleur et l'intensité lumineuse des luminaires. Par cette variation, la lumière passe d'une teinte claire et froide à un ton doux et chaud.

TUNEABLE WHITE (TW)

La fonction Tuneable White assure le paramétrage fluide de la température de couleur des luminaires LED. La lumière peut ainsi être ajustée à différentes ambiances et heures de la journée.

RGB RGB+W

Un luminaire compatible RVB peut couvrir l'intégralité du spectre chromatique à partir des couleurs rouge, verte et bleue, faisant diminuer l'importance du niveau de blanc. La version RVB+B optimise également le niveau de blanc et le représente avec qualité.

CLASSE DE PROTECTION

Les classes de protection indiquent les mesures de sécurité que présente un appareil pour éviter les décharges électriques. Il existe trois classes de protection, représentées à l'aide des trois symboles ci-dessous.



IK

L'indice de protection IK est une classification des matériaux de construction et des surfaces qui établit leur degré de résistance aux sollicitations mécaniques telles que coups, chocs ou pression.

IP

Les initiales « IP » sont l'abréviation de « Ingress Protection » (protection contre les infiltrations). Ce code IP normé indique grâce à son premier chiffre le type de protection contre les corps solides et les contacts, tandis que le second décrit l'étanchéité à l'eau et à l'humidité.

ANGLE DE RAYONNEMENT

L'angle de rayonnement caractérise le faisceau lumineux en tenant compte de la construction du luminaire, de la source et de la distance qui le sépare d'un objet. Plus la valeur de l'angle est faible, plus le faisceau est étroit.

UGR

L'UGR (Unified Glare Rating) mesure l'éblouissement causé par les luminaires pour soulager les yeux. Plus la valeur UGR est faible, plus l'œil perçoit la lumière comme agréable. C'est pourquoi on recommande un UGR < 19 dans les locaux de travail.

SMART LIGHTING

Le terme « smart lighting », ou éclairage connecté, regroupe les solutions d'automatisation de l'éclairage. Les technologies DALI, ZIGBEE, Casambi et BLUETOOTH permettent de piloter des luminaires connectés via des applis et d'autres systèmes de commande.

LALU®
1007519+1007522



LALU®
1007520+1007532





Retrouvez les **NUMINOS®** dans les pages familles 82-93

LED

NEW



Retrouvez les **NEW TRIA®** dans les pages familles 122-147

LED



Retrouvez les **MEDO®** dans les pages familles 168-171

LED

NEW



LED

UNIVERSAL DOWNLIGHT | 205

NEW



LED

UNIVERSAL DOWNLIGHT | 207

NEW



LED

UNIVERSAL DOWNLIGHT | 208

NEW



LED

UNIVERSAL DOWNLIGHT | 209

NEW



LED

KADUX | 213

NEW



LED

KADUX | 213

NEW



LED

KADUX | 213



SCKET

KADUX | 214



SCKET

KADUX | 214



SCKET

KADUX | 214



SCKET

KADUX | 215



SCKET

KADUX | 215



LED

MILANDOS 4 | 217



LED

MILANDOS 6 | 217



LED

MILANDOS 8 | 217



LED

HORN MINI | 218



SCKET

HORN | 219



SCKET

HORN | 219



SCKET

HORN | 219



SCKET

HORN | 220



SCKET

HORN | 220



SCKET

HORN | 220



SCKET

HORN-T | 221



LED

HORN MAGNA | 221



LED

SENER 12 | 223



LED

SENER 18 | 223



LED

SENER 24 | 223



LED

SENER 12 | 225



LED

SENER 18 | 225



LED

SENER 24 | 225



LED

VERLUX | 227



LED

VERLUX | 227



LED

DL 126 | 227



SCKET

PIKA | 228



SCKET

PIKA | 228



LED

OCULUS | 229



LED
OCCULDAS 14 | 230



LED
OCCULDAS 23 | 230



LED
CONTONE® | 231



LED
CONTONE® | 231



LED
H-LIGHT | 232



LED
KARPO 30 | 232



SCKET
PLASTRA | 233



SCKET
PLASTRA | 233



LED
DEKLED | 234



SCKET
VARU | 234



SCKET
DOLIX OUT | 235



SCKET
DOLIX OUT | 235



LED
KAMUELA ECO | 236



LED
KAMUELA ECO | 237



LED
KINI | 237



LED
AKALO D83 | 237



LED
FRAME BASIC SET | 238



LED
FRAME BASIC | 238



LED
FRAME BASIC | 238



LED
FRAME CURVE | 239



LED
FRAME CURVE | 239



LED
QUAD FRAME 9 | 240



LED
NOTAPO S | 241



LED
NOTAPO L | 241



LED
DOWNUNDER PUR 80 | 242



LED
DOWNUNDER PUR 150 | 242



LED
MOBALA | 243



LED
WORO | 243



LED
LED PANEL | 243



LED
PATTA-I | 244



LED
PATTA-I | 244



LED
PATTA-I | 245



LED
PATTA-I | 245



LED
PATTA-F | 246



LED
PATTA-F | 247

ENCASTRÉS MURAUX EXTÉRIEUR



ENCASTRÉS DE SOL EXTÉRIEUR

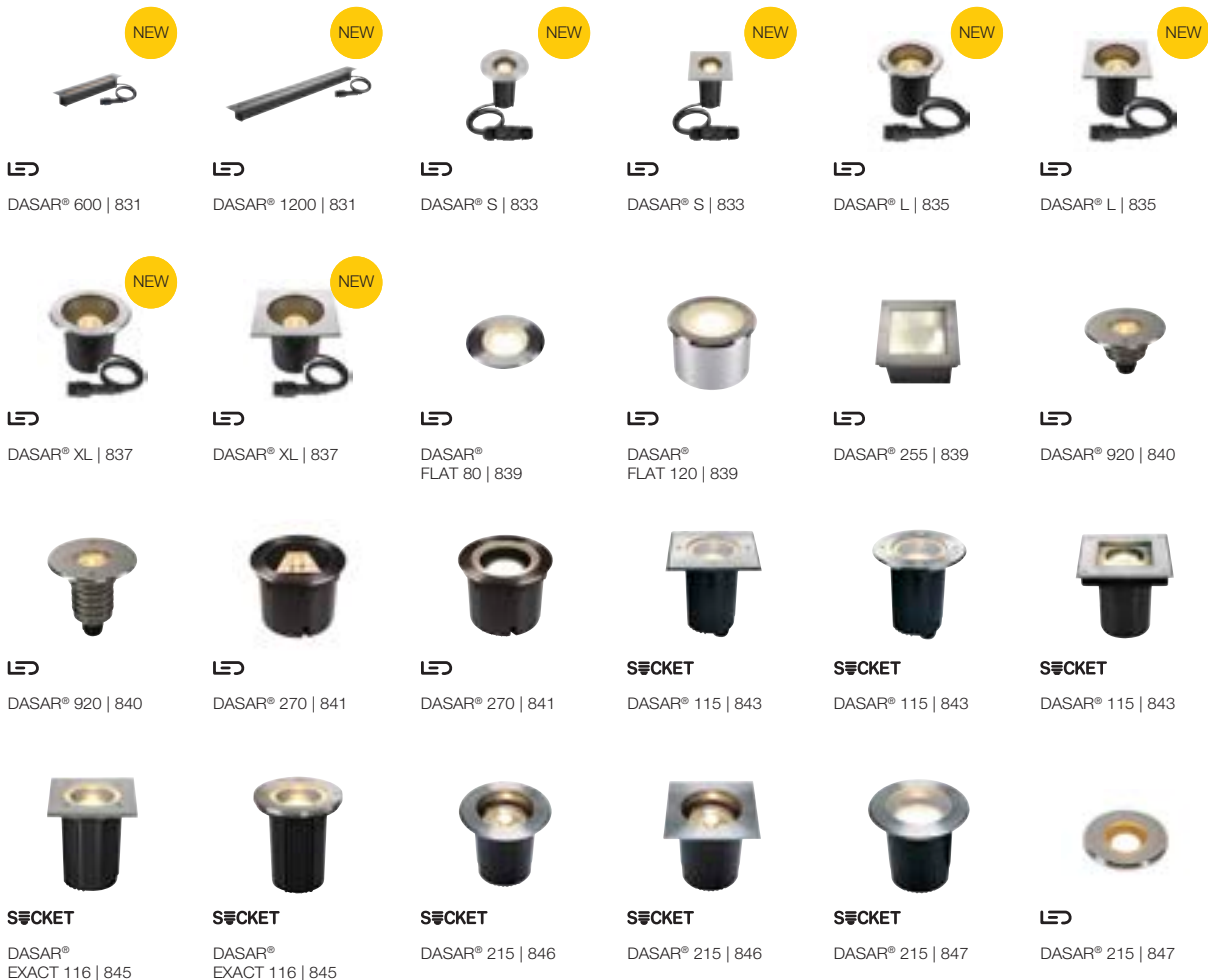



LED
TRAIL-LITE® 60 | 848



LED
POWER TRAIL-LITE® | 849



LED
POWER TRAIL-LITE® | 849



LED
GIMBLE OUT | 849



LED
SMALL PLOT | 851



LED
SMALL PLOT | 851



SMALL PLOT | 851



SMALL PLOT | 851



LED
BIG PLOT | 853



LED
BIG PLOT | 853



BIG PLOT | 853



BIG PLOT | 853



LED
ROCCI | 854



LED
ROCCI | 854



LED
ROCCI 200 | 855



LED
ROCCI 200 | 855



SCKET
SOLASTO | 857



SCKET
SOLASTO | 857





Retrouvez les **NUMINOS®** dans les pages familles 102–105

LED



Retrouvez les **MEDO®** dans les pages familles 164–165

LED



SCKET
VARYT | 251



LED
Q-LINE® | 253



LED
Q-LINE® | 253



SCKET
TRILEDO | 255



SCKET
TRILEDO | 255



SCKET
TRILEDO | 255



LED
TRILEDO | 257



LED
TRILEDO | 257



LED
TRILEDO | 257



LED
OCULUS | 258



SCKET
ENOLA B | 259



LED
ENOLA C | 259



SCKET
ASTINA | 261



SCKET
NAGY 75 | 261



LED
ANELA | 261



LED
OCCULDAS 13 | 262



LED
OCCULDAS 23 | 262



SCKET
ALTRA DICE | 263



SCKET
ALTRA DICE | 263



SCKET
KARDAMOD | 265



SCKET
KARDAMOD | 265



SCKET
FENDA | 266



FENDA | 267



FENDA | 267



FENDA | 267



SCKET
TENORA | 268



SCKET
SOPRANA | 269



SCKET
PLASTRA | 270



LED
PLASTRA | 271



SCKET
PLASTRA 105 | 271



SCKET
PLASTRA 104 | 271



LED
FERA 25 | 272



LED
FERA 25 | 272



LED
MARONA | 273



LED
PANEL 60 | 274



LED
PANEL | 275



LED
PANEL 60 | 275



LED
PANEL | 275



PLAFONNIERS EXTÉRIEUR



SCKET
PHOTONI | 789



LED
S-CUBE | 791



LED
ESKINA FRAME | 791



LED
ENOLA
OCULUS | 792



LED
ENOLA
ROUND S | 793



LED
ENOLA
ROUND M | 793



LED
ENOLA
ROUND L | 793



LED
ENOLA
SQUARE S | 795



LED
ENOLA
SQUARE M | 795



LED
ENOLA
SQUARE L | 795



LED
BIG THEO | 797



SCKET
BIG THEO | 797



LED
OVALISK | 797



SCKET
PHOTONIA | 799



SCKET
MOLAT | 799



SCKET
SITRA | 801



SCKET
ROX | 801



SCKET
ROX | 801





Retrouvez les **NUMINOS®** dans les pages familles 106–109

LED



Retrouvez les **MEDO®** dans les pages familles 166–167

LED



NEW

Retrouvez les **LALU®** dans les pages familles 176–185

LED



Retrouvez les **ONE®** dans les pages familles 186–191

LED



SCKET
PANTILO ROPE 19 | 279



SCKET
PANTILO ROPE 20 | 279



SCKET
PANTILO ROPE 27 | 279



SCKET
PANTILO OVAL | 281



SCKET
PANTILO 20 | 281



SCKET
PANTILO 28 | 281



SCKET
PANTILO CONVEX 29 | 283



SCKET
PANTILO CONVEX 40 | 283



SCKET
ASTO TUBE | 285



SCKET
ASTO TUBE | 285



SCKET
ASTO TUBE | 285



SCKET
ASTO TUBE | 285



LED
WORKLIGHT PRO 120 | 287



LED
WORKLIGHT PRO 150 | 287



LED
WORKLIGHT | 288



LED
I-PENDANT PRO | 289



LED
PANEL 60 | 289



LED
NOYA | 290



LED
GLENOS® | 291



LED
GLENOS® | 291



LED
Q-LINE® | 293



LED
Q-LINE® | 293



LED
Q-LINE® | 293



LED
OCULUS | 294



SCKET
FITU | 295



SCKET
FENDA | 296



FENDA | 296



FENDA | 296



FENDA | 297



FENDA | 297



FENDA | 297



HELIA
AMBIENT 35 | 300



HELIA
AMBIENT 35 | 300



HELIA 30 | 301



HELIA 30 | 301



HELIA 40 | 303



HELIA 40 | 303



ASTINA | 305



ENOLA B | 305



ENOLA | 305



ANELA | 306



LISENNE | 306



TONGA® | 307



QUADRASS | 307



PARA CONE GL | 309



PARA CONE 20 | 309



PARA CONE 30 | 309



PHELIA 10 | 310



PHELIA 20 | 311



PHELIA 25 | 311



PHELIA 30 | 311



FORCHINI 50 | 312



FORCHINI 70 | 312



FORCHINI M 40 | 313



FORCHINI M 50 | 313



LIGHT EYE® 90 | 314



LIGHT EYE® 150 | 314



SUN / BIG SUN | 315



ROTOBALL 25 | 317



ROTOBALL 40 | 317



ROTOBALL 50 | 317



PARA DOME | 318



PARA DOME | 318



PARA DOME | 318



PARA 380 | 319

APPLIQUES INTÉRIEUR



LED
LYGANT | 325



LED
LYGANT | 325



SCKET
VARYT | 327



LED
SEDO 7 | 329



LED
SEDO 14 | 329



LED
SEDO 21 | 329



LED
TRUKKO | 330



LED
TRUKKO | 330



LED
TRUKKO | 331



LED
TRUKKO 80 | 331



LED
TRUKKO 60 | 332



LED
TRUKKO 90 | 332



LED
MARYLIN 40 | 333



LED
WL 149 | 334



SCKET
WL 149 | 334



SCKET
WL 106 | 335



SCKET
WL 106 | 335



SCKET
MIBO UP/DOWN | 337



LED
MAGANDA | 337



LED
DORISA 30 | 339



LED
DORISA 50 | 339



LED
GLENOS® 60 | 339



LED
L-LINE 60 | 341



LED
L-LINE 120 | 341



LED
Q-LINE® | 341

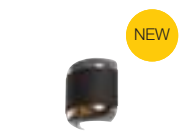

SCKET
PANTILO ROPE | 345



SCKET
ASTO TUBE | 347



SCKET
ASTO TUBE | 347



LED
MANA BASE | 349



LED
MANA BASE | 349



LED
MANA 40 | 319



LED
MANA 60 | 349



LED
MANA | 351



LED
MANA | 351



LED
MANA | 351



LED
MANA | 353



LED
MANA | 353



LED
MANA | 353



LED
MANA | 353



LED
OCULUS | 355



LED
OCULUS
UP/DOWN | 355



SCKET
PLASTRA | 356



SCKET
PLASTRA | 356



SCKET
PLASTRA | 357



SCKET
PLASTRA | 357



SCKET
PLASTRA | 359



LED
PLASTRA | 359



LED
PLASTRA | 359



SCKET
PLASTRA | 360



SCKET
PLASTRA 101 | 361



SCKET
PLASTRA | 361



SCKET
PLASTRA 104 | 361



LED
LOGS IN | 362



LED
LOGS IN | 362



LED
LOGS IN L | 363



LED
LOGS IN L | 363



LED
QUAD FRAME 14 | 364



LED
QUAD FRAME 19 | 364



LED
SHELL 15 | 365



LED
SHELL 30 | 365

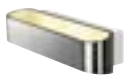

LED
ASSO 300 | 366



LED
ASSO 300 | 367



SCKET
OSSA 180 | 367



SCKET
OSSA 300 | 367



LED
CARISO | 368



LED
CARISO | 368



LED
CHROMBO | 369



LED
DIRETO 60 | 370



LED
DIRETO 90 | 370



LED
ARLINA 60 | 371



LED
ARLINA 130 | 371



SCKET
ANDREAS | 373



SCKET
DENA 30 | 373



SCKET
BASKET | 373



SCKET
QUADRASS | 375



LED
QUADRASS
SPOT | 375



SCKET
LISENNE | 375



SCKET
FITU | 376



SCKET
FITU CUBE | 376



SCKET
THEO UP/DOWN | 377



SCKET
SOLID CUBE | 377



ENOLA B | 379



ENOLA B | 379



ASTINA
UP/DOWN | 379

APPLIQUES INTÉRIEUR



SCKET
FENDA | 380



FENDA | 380



LED
KENKUA SPOT | 381



LED
COUPA FLEX | 381



LED
KARPO MAGN | 382



LED
KARPO GOOSE | 382



LED
KARPO 30 | 383



LED
KARPO | 383



LED
SOMNILA SPOT | 384



LED
SOMNILA SPOT | 385



LED
SOMNILA FLEX | 385



LED
SOMNILA FLEX | 385



SCKET
DIO FLEX PLATE | 387



LED
DIO FLEX PLATE | 387



LED
DIO FLEX PLATE | 387



SCKET
PHELIA | 388



LED
MERADO FLOOD | 388



SCKET
DISPLAY ADL 50 | 389



APPLIQUES EXTÉRIEUR



NEW

SCKET
PHOTONI | 709

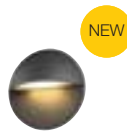

NEW

LED
LID II | 711

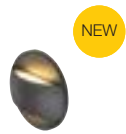

NEW

LED
LID II | 711



NEW

LED
LID I | 713



NEW

LED
LID I | 713



NEW

LED
I-RING | 714



NEW

LED
OVAL 14 | 715



NEW

LED
OVAL 18 | 715



NEW

LED
CONCRETO M | 717



NEW

LED
CONCRETO L | 717



LED
VANO WING | 719



LED
VANO WING | 719



LED
MANA BASE | 720



NEW

RUSTY® MANA | 720



NEW

RUSTY® MANA | 720



LED
MANA OUT | 721



NEW

LED
MANA OUT | 721



NEW

LED
ENOLA OCULUS | 723



NEW

LED
ENOLA OCULUS | 723



LED
ENOLA OCULUS S | 725



LED
ENOLA OCULUS M | 725



LED
ENOLA ROUND L | 725



LED
ENOLA ROUND S UP/DOWN | 727



LED
ENOLA ROUND M UP/DOWN | 727



LED
ENOLA ROUND L UP/DOWN | 727



LED
ENOLA SQUARE S | 729



LED
ENOLA SQUARE M | 729



LED
ENOLA SQUARE L | 729



LED
ENOLA SQUARE S UP/DOWN | 730



LED
ENOLA SQUARE M UP/DOWN | 730



LED
ENOLA SQUARE L UP/DOWN | 730



SCKET
THEO UP/DOWN | 735



LED
BIG THEO BEAM UP/ FLOOD DOWN | 735



SCKET
BIG THEO UP/DOWN | 735



LED
BIG THEO FLOOD UP/DOWN | 736



SCKET
THEO | 736



SCKET
BIG THEO | 737



LED
BIG THEO | 737



LED
SITRA S | 739



LED
SITRA S | 739



LED
SITRA M | 741



LED
SITRA L | 741

NEW



SCKET
SITRA CUBE | 741



SCKET
GRAFIT | 742



SCKET
GRAFIT | 742



SCKET
GRAFIT | 743



SCKET
GRAFIT | 743



LED
QUADRULO | 744



SCKET
QUADRULO
SENSOR | 745



SCKET
QUADRULO | 745



SCKET
MERIDIAN | 746



SCKET
MERIDIAN BOX | 746



SCKET
MERIDIAN BOX
SENSOR | 747



SCKET
MERIDIAN BOX | 747



LED
ESKINA FRAME | 749



LED
ESKINA FRAME | 749



LED
ESKINA FRAME | 749



LED
BOOKAT | 751



LED
BIG QUAD | 752



LED
QUAD | 752



LED
QUAD
UP/DOWN 15 | 753



LED
BIG QUAD
UP/DOWN | 755



LED
BIG QUAD | 755



LED
RUSTY®
UP/DOWN | 756



LED
RUSTY®
UP/DOWN | 756



LED
OVALISK
SENSOR | 757



LED
OVALISK | 757



LED
PEMA® | 758



LED
PEMA® | 759



LED
PEMA® | 759



SCKET
PEMA® | 759



LED
FLATT SENSOR | 760



LED
FLATT | 760



SCKET
ASTINA | 761



SCKET
ASTINA STEEL | 761



LED
ANGOLUX
SENSOR | 762



LED
ANGOLUX | 762



LED
VILUA S | 763



LED
VILUA L | 763



LED
VILUA | 763



SCKET
MYRA
UP/DOWN | 764



LED
SITRA
UP/DOWN | 765



SCKET
SITRA
UP/DOWN | 765



SCKET
ROX | 767



SCKET
ROX UP/DOWN | 767



LED
DELWA | 767



LED
SLOTS | 768



SCKET
WALLYX | 768



LED
DOWNUNDER
OUT | 769



LED
DOWNUNDER
OUT | 769



LED
ABRIDOR
SENSOR | 770



LED
ABRIDOR | 770



LED
ORDI SENSOR | 771



LED
ORDI | 771



SCKET
BOX-L | 773



LED
BOX-L | 773



SCKET
BOX UP/DOWN | 773



LED
LOGS | 775



LED
OUT-BEAM UP /
FLOOD DOWN | 775



LED
L-LINE OUT | 775



SCKET
PHOTONIA | 777



SCKET
MOLAT | 777



SCKET
GLOO PURE | 777



SCKET
F-POL | 778



SCKET
SQUARE | 779



SCKET
KERAS ELT | 779



SCKET
SITRA | 779



LED
RASCALI | 780



LED
IPERI | 780



SCKET
QUADRASYL | 781



SCKET
SQUARE TURN | 781



LED
TODAY PRO | 783



LED
ESKINA D | 783



SCKET
MYRA DISPLAY | 783



LED
LED SPOT | 785



SCKET
NAUTILUS | 785



SCKET
MYRA | 785



Retrouvez les **NUMINOS®** dans les pages familles 98–101

LED

NEW



Retrouvez les **MEDO®** dans les pages familles 148–163

LED



Retrouvez les **ONE®** dans les pages familles 192–193

LED

NEW



SCKET
PANTILO
ROPE 19 | 393

NEW



SCKET
PANTILO
ROPE 27 | 393

NEW



LED
CYFT | 395

NEW



SCKET
ASTO TUBE | 395

NEW



SCKET
ASTO TUBE | 397



SCKET
ASTO TUBE | 397



SCKET
ASTO TUBE | 399



SCKET
ASTO TUBE | 397



LED
OCULUS | 399



LED
KARPO 30 | 399



LED
NOBLO® | 401



LED
NOBLO® | 401



LED
NOBLO® | 401



LED
KALU | 403



LED
KALU | 403



LED
KALU | 403



LED
KALU | 403



SCKET
KALU | 405



SCKET
KALU | 405



SCKET
KALU | 405



SCKET
KALU | 405



SCKET
ENOLA B | 407



SCKET
ENOLA B | 407



SCKET
ENOLA B | 407



SCKET
ALTRA DICE | 408



SCKET
SPOT 79 | 409



SCKET
INDA | 409



SCKET
PURI | 411



SCKET
PURI | 411



SCKET
PURI | 411



SCKET
PURI | 411



SCKET
AVO | 413



SCKET
AVO | 413



SCKET
AVO | 413



SCKET
AVO | 413



SCKET
AVO | 415



SCKET
ASTO | 415



SCKET
ASTO | 415



SCKET
ASTO | 415



LED
SENSER
12, 18, 24 | 417



LED
SENSER
12, 18, 24 | 419



LED
SIMA | 420



LED
SIMA | 421



LED
LIPSY®
30, 40, 50 | 423



LED
LIPSY®
30, 40, 50 | 425-426



SCKET
MELAN | 427



SCKET
GLASSA | 427



LED
BATTEN 60 | 429



LED
BATTEN 120 | 429



LED
LONG GRILL | 430



LED
SIGHT 60 | 431



LED
SIGHT 115 | 431



LED
BENA 120 | 433



LED
BENA 150 | 433

APPLIQUES ET PLAFONNIERS EXTÉRIEUR

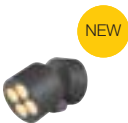

LED
R-CUBE | 805



LED
S-CUBE | 805



SCKET
S-TUBE | 805



LED
ESKINA SPOT/
SENSOR | 807



SCKET
SITRA 360 | 808



SCKET
THEO BRACKET | 808



LED
HELIA | 809



LED
HELIA | 809



SCKET
MYRA | 811



LED
OUT-BEAM
FRAME | 811



LED
QUADRULO | 811



LED
AINOS | 812-813



LED
AINOS | 813



LED
RUBA | 814



SCKET
BULAN | 815



SCKET
BULAN GRID | 815



LED
TERANG 200 | 817



LED
IMPERVA | 817

VINOLINA TWO
1007696





LAMPES À POSER ET LAMPADAIRES INTÉRIEUR



NEW

Retrouvez les ONE® dans les pages familles 196-197

LED



NEW

LED

VINOLINA ONE | 437



NEW

LED

VINOLINA | 437



NEW

LED

VINOLINA TWO | 439



NEW

LED

TAHA | 441



NEW

SCKET

TINY SUN | 443



NEW

SCKET

LITTLE SUN | 443



NEW

SCKET

VARYT | 443



NEW

LED

WORKLIGHT PRO | 444



NEW

LED

WORKLIGHT PRO | 444



LED

WORKLIGHT | 445



LED

WORKLIGHT | 445



SCKET

FENDA | 447



SCKET

FENDA | 447



SCKET

FENDA | 447



SCKET

FENDA | 448



SCKET

FENDA BOW BASIS | 448



FENDA | 448



FENDA | 449



FENDA | 449



FENDA | 449



LED

KARPO | 452



LED

KARPO | 452



SCKET

PHELIA | 453



LED

TONILA | 453



LED

MAGANDA | 453



NEW

LED
VINOLINA ONE | 597



NEW

LED
VINOLINA | 597



NEW

LED
VINOLINA TWO | 599



LED
TONILA | 601



NEW

LED
TAHA | 601



NEW

SCKET
S-TUBE 32/75 | 603



NEW

SCKET
PHOTONI 45/75 | 605



NEW

LED
S-CUBE 35/75 | 607



NEW

LED
R-CUBE 35/70 | 609



NEW

LED
LID I 75 | 611

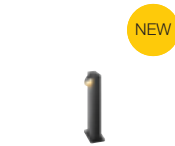

NEW

LED
LID I 45 | 611



NEW

LED
I-RING | 613



NEW

LED
M-POL S | 614



NEW

LED
M-POL S | 615



LED
M-POL S | 616



LED
M-POL S | 617



LED
M-POL S | 618



LED
M-POL M | 619



LED
M-POL M | 620



LED
M-POL M | 621



M-POL 30/60/90 | 623



SCKET
CONCRETO | 627



SCKET
CONCRETO | 627



LED
ESKINA
FRAME 45/75 | 629



LED
ESKINA
FRAME 75 | 629



LED
ESKINA FRAME
125/175 | 630



LED
ESKINA 30/80 | 631



LED
LOGS 40/70 | 633



SCKET
GRAFIT 30/60/90 | 635



SCKET
GRAFIT 30/60/90 | 637



LED
QUADRULO | 639



LED
RUSTY®
SLOT 50/80 | 640



SCKET
RUSTY®
SLOT 50/80 | 641



SCKET
RUSTY®
PATHLIGHT | 642



LED
RUSTY® 40/70 | 643



SCKET
RUSTY® 40/70 | 643



SCKET
RUSTY®
CONE 24 | 645



SCKET
RUSTY®
CONE 40/70 | 645



SCKET
RUSTY® 40/70 | 646



SCKET
ARROCK
GRANITE 40/70 | 647



SCKET
ARROCK
ARC | 648



LED
ARROCK
STONE 50/75 | 649



SCKET
ARROCK SLOT | 649



LED
L-LINE OUT 30 | 650



LED
L-LINE OUT 60 | 651



LED
L-LINE OUT 50/80 | 651



SCKET
THEO PATHLIGHT | 652



LED
OVALISK 75/100 | 653



SCKET
GLOO PURE 27/44/70 | 655



SCKET
ROTOBALL 25/40/50 | 657



SCKET
PHOTONIA | 659



SCKET
PHOTONIA | 659



SCKET
OTOS GLAS | 659



SCKET
CUBIX | 660



SCKET
CONE | 660



SCKET
MOLAT | 661



SCKET
MOLAT | 661



SCKET
LISENNE 40/70 | 662



SCKET
ADEGAN MANILA | 663



SCKET
ADEGAN | 663



SCKET
ALPA MUSHROOM 45/75 | 665



SCKET
ALPA CONE 100 | 665



LED
APONI 90/120 | 666



LED
TRUST 30/60 | 667



SCKET
BIG NAILS 50/80 | 668



SCKET
ROX ACRYL 30/60/90 | 669



SCKET
VAP SLIM 30/60/90 | 671



SCKET
C-POL | 672



SCKET
F-POL | 672



SCKET
SQUARE POLE 30/60/90 | 673



LED
SLOTS 45/65 | 675



LED
H-POL 30/60 | 676



LED
H-POL TWIN 30/60 | 677



LED
SLOTBOX 40/70 | 678



LED
FLATT 65/100 | 679



LED
ABRIDOR 60/100 | 681



LED
IPERI 50 | 681



SCKET
QUADRASYL 75 | 682



LED
QUAD POLE | 683



LED
BOOKAT | 683



LED
RASCALI 45/65 | 684



SCKET
MYRA SPOT | 685



SCKET
SITRA 360 | 685

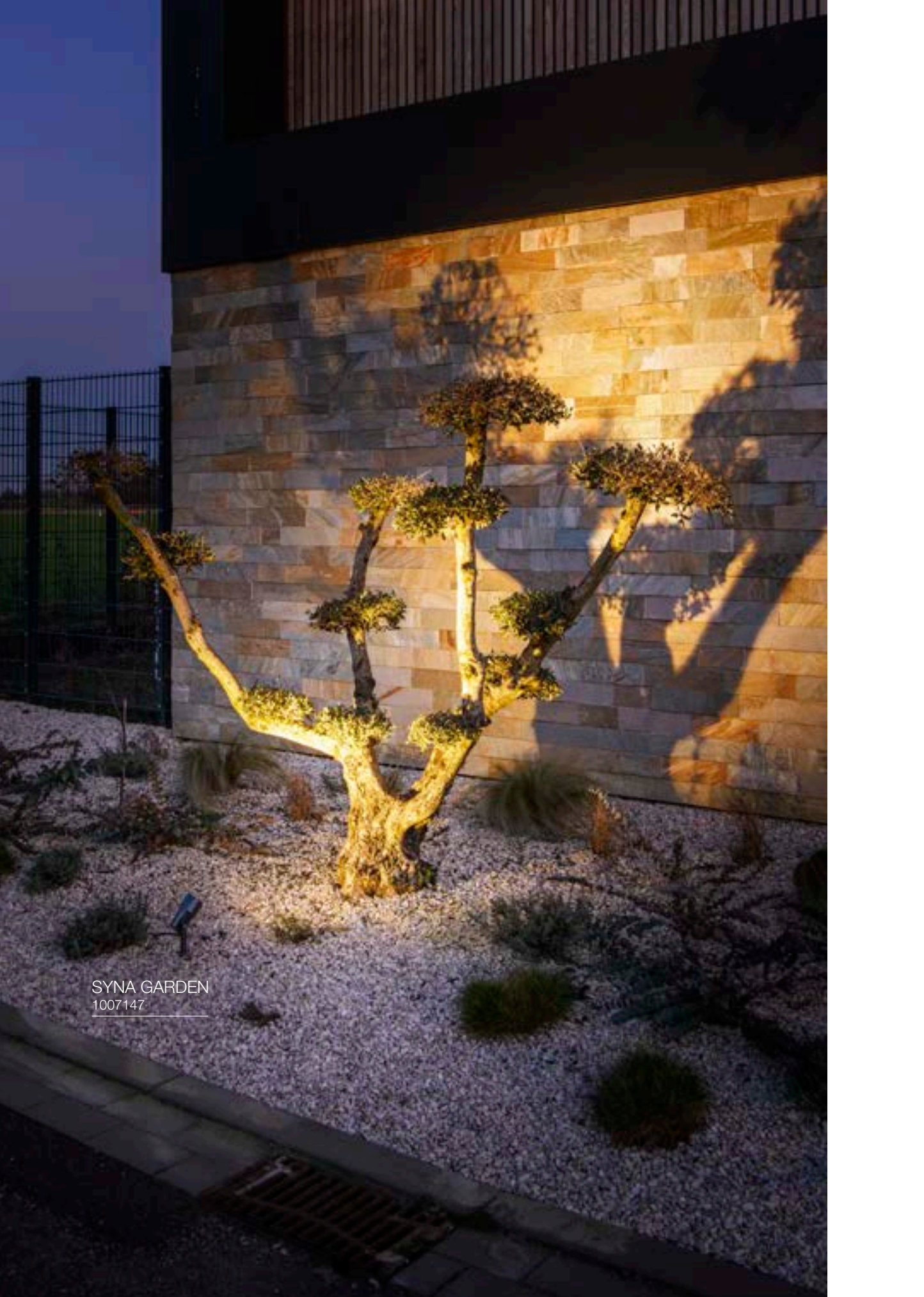

SYNA GARDEN
1007147



PROJECTEURS EXTÉRIEUR



LED
SYNA PLANT | 689



LED
SYNA GARDEN | 689



LED
SYNA | 689



LED
FLOODI S | 691



LED
FLOODI M | 691



LED
FLOODI L | 691



LED
GALEN 60 | 692



LED
GALEN 120 | 692



LED
FLAC BEAM® | 693



SĀCKET
SAMRINA | 693



SĀCKET
NAUTILUS 10 | 694



SĀCKET
BIG NAUTILUS | 694



SĀCKET
NAUTILUS 10 | 695



LED
NAUTILUS 10 | 696



SĀCKET
NAUTILUS | 697



SĀCKET
NAUTILUS 10
SPOT | 697



LED
NAUTILUS 10
SPOT LED | 697



LED
DASAR®
PROJECTOR | 698



LED
DASAR® 920 | 698



LED
HELIA SPOT S | 699



LED
HELIA SPOT L | 699



SĀCKET
THEO BRACKET | 701



LED
LED SPIKE | 701



SĀCKET
SITRA 360 SPIKE | 703



SĀCKET
SITRA 360 SPIKE | 703

IN-LINE 44
1006621

NUMINOS® XS
1006762

NUMINOS® XS
1006654

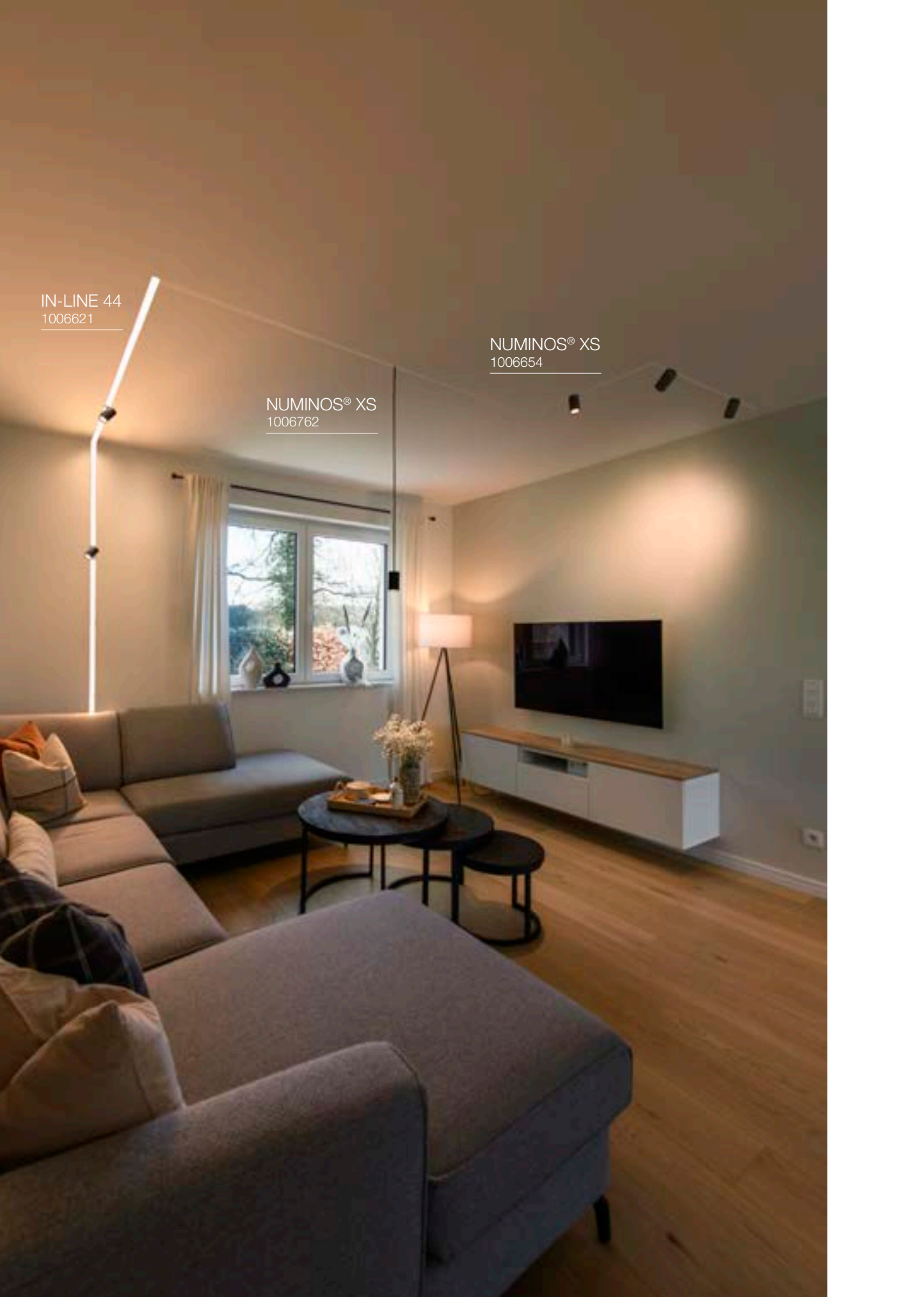













SYSTÈMES 48V INTÉRIEUR

					
NEW	NEW	NEW	NEW	NEW	NEW
LED NUMINOS® XS 468	LED NUMINOS® S 468	LED NUMINOS® XS 470	LED NUMINOS® S 470	LED IN-LINE 22 473	LED IN-LINE 22 475
					
NEW	NEW	NEW	NEW		
LED IN-LINE 44 475	LED IN-LINE 44 475	LED IN-LINE 24 477	LED IN-LINE 46 477		

SYSTÈME DE CÂBLE TENDU T.B.T. INTÉRIEUR

					
SCKET ASMARA 486	SCKET TELESKOP 486	SCKET COSMIC 487	SCKET SYROS 489	SCKET SALUNA 489	LED DURNO 489
					
LED PLYTTA 490	LED NOBLO® SPOT 491	LED COMET LED 491	SCKET COMET 491		

NOBLO® SPOT
1007352





SYSTÈMES 1 ALLUMAGE INTÉRIEUR



NEW

LED
NOBLO® SPOT | 501



NEW

LED
NOBLO® SPOT | 501



NEW

LED
NOBLO® SPOT | 503



NEW

LED
NOBLO® SPOT | 503



NEW

SCKET
ASTO TUBE | 505



NEW

SCKET
PANTILO
ROPE 19 | 505



LED
HELIA 50 TRACK | 507



LED
PANEL TRACK | 507



LED
PANEL TRACK | 507



SCKET
PARA CONE GL | 508



SCKET
PARA CONE GL | 508



SCKET
PARA CONE 14 | 509



SCKET
PARA CONE 14 | 509



SCKET
TONGA® | 511



SCKET
LIGHT EYE® 90 | 511



SCKET
LIGHT EYE® 150 | 511



SCKET
FORCHINI M 40
TRACK | 512



SCKET
PURI TRACK | 513



SCKET
PURI TRACK | 513



SCKET
PURI TRACK | 515



SCKET
AVO TRACK | 515



LED
ENOLA C TRACK | 516



LED
ENOLA C TRACK | 517



SCKET
ENOLA B TRACK | 517



SCKET
ENOLA B | 517



SCKET
BIMA | 519



SCKET
BIMA | 519



LED
KALU TRACK | 520



SCKET
KALU TRACK | 520



SCKET
EURO SPOT
TRACK | 521



SCKET
ALTRA DICE
TRACK | 521

TS V
1007655





SYSTÈMES 3 ALLUMAGES INTÉRIEUR



Retrouvez les **NUMINOS®** dans les pages familles 110–115

LED



Retrouvez les **ONE®** dans les pages familles 194–195

LED



TS V | 543



TS V | 543



NOBLO® SPOT | 545



NOBLO® SPOT | 545



NOBLO® SPOT | 547



NOBLO® SPOT | 547



SCKET
PANTILO
ROPE 19 | 549



LED
SIGHT TRACK | 550



LED
SIGHT TRACK | 550



LED
SIGHT MOVE | 551



LED
SIGHT MOVE | 551



SCKET
PARA CONE GL | 552



SCKET
PARA CONE GL | 552



SCKET
PARA CONE 14 | 553



SCKET
PARA CONE 14 | 553



SCKET
FORCHINI M 40
TRACK | 554



LED
EURO CUBE | 555



SCKET
EURO SPOT
TRACK | 555



SCKET
EURO SPOT
TRACK | 555



SCKET
ALTRA DICE
TRACK | 556



SCKET
PURI TRACK | 557



SCKET
PURI TRACK
GLASS | 557



LED
KALU TRACK
LED | 558



SCKET
KALU TRACK | 558



SCKET
BIMA | 559



SCKET
BIMA | 559



LED
HELIA 50 TRACK | 561



LED
ENOLA C TRACK | 561



SCKET
AVO TRACK | 561

GRAZIA PRO
FLEXSTRIP
1007352

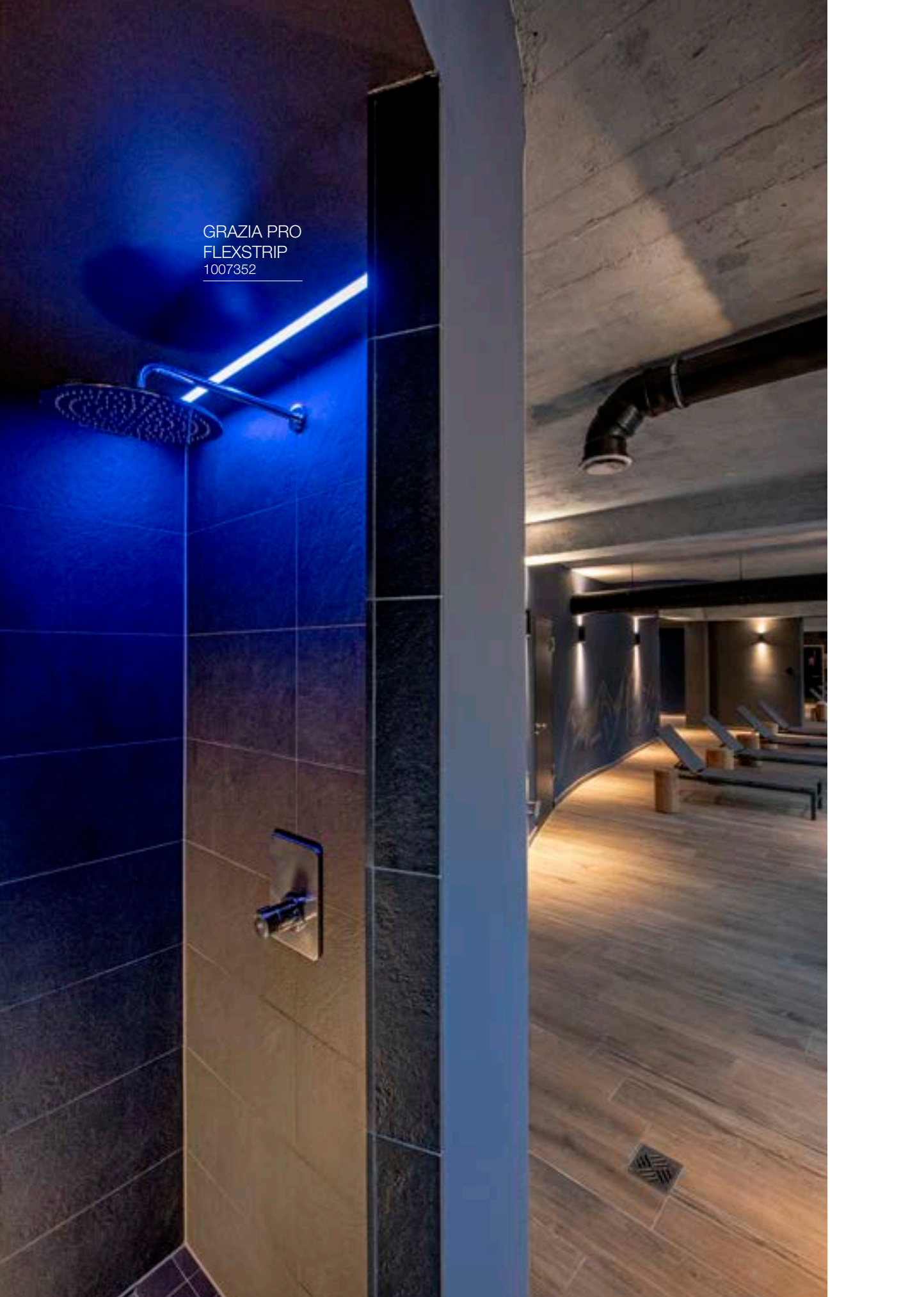

PROFILS



GRAZIA 10 PROFIL EN SAILLIE | 567

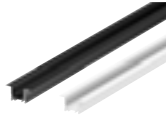

GRAZIA 10 PROFIL ENCASTRÉ | 567

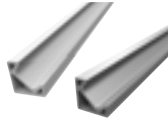

GRAZIA 10 EDGE | 570

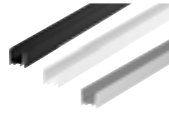

GRAZIA 20 PROFIL EN SAILLIE | 573



GRAZIA 20 PROFIL ENCASTRÉ | 573

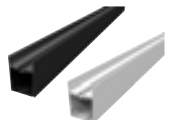

GRAZIA 60 PROFIL EN SAILLIE | 577

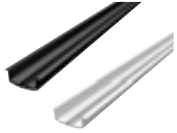

GRAZIA 60 PROFIL ENCASTRÉ | 577



GRAZIA 10 ACCESSOIRES | 569



GRAZIA 10 EDGE ACCESSOIRES | 571



GRAZIA 20 ACCESSOIRES | 574-575



GRAZIA 60 ACCESSOIRES | 578-579

BANDEAUX LED



GRAZIA FLEXSTRIP LED | 582



GRAZIA PRO FLEXSTRIP LED | 583



GRAZIA PRO MAX FLEXSTRIP | 585



GRAZIA PRO FLEXSTRIP TUNABLE WHITE | 587



GRAZIA PRO FLEXSTRIP RGBW | 589



GRAZIA IP FLEXSTRIP | 591



GRAZIA FLEXSTRIP LED ACCESSOIRES | 582



GRAZIA PRO FLEXSTRIP LED ACCESSOIRES | 583



GRAZIA PRO MAX FLEXSTRIP ACCESSOIRES | 585



GRAZIA PRO FLEXSTRIP TUNABLE WHITE ACCESSOIRES | 587



GRAZIA PRO FLEXSTRIP RGBW ACCESSOIRES | 589

TAHA
1007380



MEDO® PRO 90
1007309



ABRIDOR



LED
ABRIDOR 60/100 | 681



LED
ABRIDOR
SENSOR | 770



LED
ABRIDOR | 770

ADEGAN



SCKET
ADEGAN
MANILA | 663



SCKET
ADEGAN | 663

AINOS



LED
AINOS | 812-813



LED
AINOS | 813



LED
AINOS | 813

ALPA



SCKET
ALPA MUSHROOM
45/75 | 665



SCKET
ALPA CONE 100 | 665



ALTRA DICE



SCKET

ALTRA DICE | 263



SCKET

ALTRA DICE | 263



SCKET

ALTRA DICE | 408



SCKET

ALTRA DICE
TRACK | 521



SCKET

ALTRA DICE
TRACK | 556

ANELA



LED

ANELA | 261



LED

ANELA | 306

ARROCK



SCKET

ARROCK
GRANITE 40/70 | 647



SCKET

ARROCK ARC | 648



LED

ARROCK
STONE 50/75 | 649



SCKET

ARROCK SLOT | 649

ASTINA



SCKET

ASTINA | 261



SCKET

ASTINA | 305



ASTINA
UP/DOWN | 379



SCKET

ASTINA | 761



SCKET

ASTINA STEEL | 761

ASTO



SCKET

ASTO TUBE | 285



SCKET

ASTO TUBE | 285



SCKET

ASTO TUBE | 285



SCKET

ASTO TUBE | 285



NEW

SCKET

ASTO TUBE | 347



NEW

SCKET

ASTO TUBE | 347



NEW

SCKET

ASTO TUBE | 395



NEW

SCKET

ASTO TUBE | 397



NEW

SCKET

ASTO TUBE | 397

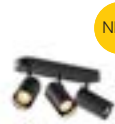

NEW

SCKET

ASTO TUBE | 399



NEW

SCKET

ASTO TUBE | 397



SCKET

ASTO | 415



SCKET

ASTO | 415



SCKET

ASTO | 415



NEW

SCKET

ASTO TUBE | 505

AVO



SCKET

AVO | 413



SCKET

AVO | 413



SCKET

AVO | 413



SCKET

AVO | 413



SCKET

AVO | 415



SCKET

AVO TRACK | 515/561

BIMA



SCKET

BIMA | 519



SCKET

BIMA | 519



SCKET

BIMA | 559



SCKET

BIMA | 559



BOOKAT



LED

BOOKAT | 751



LED

BOOKAT | 683

BOX



SCKET

BOX-L | 773



LED

BOX-L | 773



SCKET

BOX UP/DOWN | 773

BRICK



LED

BRICK MESH | 825



LED

BRICK | 825



LED

BRICK | 825



SCKET

BRICK
DOWNUNDER | 827



LED

BRICK
DOWNUNDER | 827

BULAN



SCKET

BULAN | 815



SCKET

BULAN GRID | 815

CARISO



LED
CARISO | 368



LED
CARISO | 368

CONCRETO



SCKET
CONCRETO | 627



SCKET
CONCRETO | 627



NEW

LED
CONCRETO M | 717



NEW

LED
CONCRETO L | 717



NEW

SCKET
CONCRETO | 821



NEW

LED
CONCRETO | 821

CONTONE®



LED
CONTONE® | 231



LED
CONTONE® | 231

CUBE



NEW

LED
S-CUBE 35/75 | 607



NEW

LED
R-CUBE 35/70 | 609



NEW

LED
S-CUBE | 791



NEW

LED
R-CUBE | 805



NEW

LED
S-CUBE | 805



DASAR®



LED
DASAR® 600 | 831



LED
DASAR® 1200 | 831



LED
DASAR® S | 833



LED
DASAR® S | 833



LED
DASAR® L | 835



LED
DASAR® L | 835



LED
DASAR® XL | 837



LED
DASAR® XL | 837



LED
DASAR® FLAT 80 | 839



LED
DASAR® FLAT 120 | 839



LED
DASAR® 255 | 839



LED
DASAR® 920 | 840



LED
DASAR® 920 | 840



LED
DASAR® 270 | 841



LED
DASAR® 270 | 841



SOCKET
DASAR® 115 | 843



SOCKET
DASAR® 115 | 843



SOCKET
DASAR® 115 | 843



SOCKET
DASAR® EXACT 116 | 845



SOCKET
DASAR® EXACT 116 | 845



SOCKET
DASAR® 215 | 846



SOCKET
DASAR® 215 | 846



SOCKET
DASAR® 215 | 847



LED
DASAR® 215 | 847



LED
DASAR® PROJECTOR | 698



LED
DASAR® 920 | 698

DIO FLEX



SOCKET
DIO FLEX PLATE | 387



LED
DIO FLEX PLATE | 387



LED
DIO FLEX PLATE | 387

DOLIX



SCKET

DOLIX OUT | 235



SCKET

DOLIX OUT | 235

DOWNUNDER OUT



LED

DOWNUNDER
OUT | 769



LED

DOWNUNDER
OUT | 769



LED

DOWNUNDER
OUT S | 823



LED

DOWNUNDER
OUT M | 823



LED

DOWNUNDER
OUT L | 823

ENOLA



SCKET

ENOLA B | 259



LED

ENOLA C | 259



SCKET

ENOLA B | 305



SCKET

ENOLA | 305



ENOLA B | 379



ENOLA B | 379



SCKET

ENOLA B | 407



SCKET

ENOLA B | 407



SCKET

ENOLA B | 407



LED

ENOLA C TRACK | 516



LED

ENOLA C TRACK | 517



SCKET

ENOLA B TRACK | 517



SCKET

ENOLA B | 517



LED

ENOLA C TRACK | 561



NEW

LED

ENOLA
OCULUS | 723

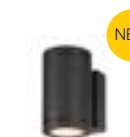

NEW

LED

ENOLA
OCULUS | 723



LED

ENOLA
OCULUS S | 725



LED

ENOLA
OCULUS M | 725



LED
ENOLA
ROUND L | 725



LED
ENOLA ROUND S
UP/DOWN | 727



LED
ENOLA ROUND M
UP/DOWN | 727



LED
ENOLA ROUND L
UP/DOWN | 727



LED
ENOLA
SQUARE S | 729



LED
ENOLA
SQUARE M | 729



LED
ENOLA
SQUARE L | 729



LED
ENOLA SQUARE S
UP/DOWN | 730



LED
ENOLA SQUARE M
UP/DOWN | 730



LED
ENOLA SQUARE L
UP/DOWN | 730



LED
ENOLA
OCULUS | 792



LED
ENOLA
ROUND S | 793



LED
ENOLA
ROUND M | 793



LED
ENOLA
ROUND L | 793



LED
ENOLA
SQUARE S | 795



LED
ENOLA
SQUARE M | 795



LED
ENOLA S
QUARE L | 795

ESKINA



LED
ESKINA
FRAME 45/75 | 629



LED
ESKINA
FRAME 75 | 629



LED
ESKINA FRAME
125/175 | 630



LED
ESKINA 30/80 | 631



LED
ESKINA FRAME | 749



LED
ESKINA FRAME | 749



LED
ESKINA FRAME | 749



LED
ESKINA D | 783



LED
ESKINA FRAME | 791



LED
ESKINA SPOT
SENSOR | 807



LED
ESKINA SPOT | 807

EURO SPOT



SCKET
EURO SPOT
TRACK | 521



SCKET
EURO SPOT
TRACK | 555



SCKET
EURO SPOT
TRACK | 555

FENDA



SCKET
FENDA | 266



SCKET
FENDA | 296



SCKET
FENDA | 447



SCKET
FENDA | 447



SCKET
FENDA | 447



SCKET
FENDA | 448



SCKET
FENDA BOW
BASIS | 448



SCKET
FENDA | 380



FENDA | 380



FENDA | 296



FENDA | 296, 448



FENDA | 267, 297, 449



FENDA | 267, 297, 449



FENDA | 267, 297, 449

FITU



SCKET
FITU | 295



SCKET
FITU | 376



SCKET
FITU CUBE | 376



FLATT



LED

FLATT 65/100 | 679



LED

FLATT SENSOR | 760



LED

FLATT | 760

FORCHINI



SCKET

FORCHINI 50 | 312



SCKET

FORCHINI 70 | 312



SCKET

FORCHINI M 40 | 313



SCKET

FORCHINI M 50 | 313



SCKET

FORCHINI M 40
TRACK | 512



SCKET

FORCHINI M 40
TRACK | 554

F-POL



SCKET

F-POL | 672



SCKET

F-POL | 778

GLENOS®



LED

GLENOS® | 291



LED

GLENOS® | 291



LED

GLENOS® 60 | 339

GLOO PURE



SCKET

GLOO PURE
27/44/70 | 655



SCKET

GLOO PURE | 777

GRAFIT



SCKET

GRAFIT 30/60/90 | 635



SCKET

GRAFIT 30/60/90 | 637



SCKET

GRAFIT | 742



SCKET

GRAFIT | 742



SCKET

GRAFIT | 743



SCKET

GRAFIT | 743

HELIA



LED

HELIA
AMBIENT 35 | 300



LED

HELIA
AMBIENT 35 | 300



LED

HELIA 30 | 301



LED

HELIA 30 | 301



LED

HELIA 40 | 303



LED

HELIA 40 | 303



LED

HELIA 50 TRACK | 507



LED

HELIA 50 TRACK | 561



LED

HELIA SPOT S | 699



LED

HELIA SPOT L | 699



LED

HELIA | 809



LED

HELIA | 809



HORN



LED
HORN MINI | 218



SCKET
HORN | 219



SCKET
HORN | 219



SCKET
HORN | 219



SCKET
HORN | 220



SCKET
HORN | 220



SCKET
HORN | 220



SCKET
HORN-T | 221



LED
HORN MAGNA | 221

H-POL



LED
H-POL 30/60 | 676



LED
H-POL TWIN
30/60 | 677

IPERI



LED
IPERI 50 | 681



LED
IPERI | 780

I-RING



LED
I-RING | 613



LED
I-RING | 714

KADUX



LED
KADUX | 213



LED
KADUX | 213



LED
KADUX | 213



SCKET
KADUX | 214



SCKET
KADUX | 214



SCKET
KADUX | 214



SCKET
KADUX | 215



SCKET
KADUX | 215

KALU



LED
KALU | 403



LED
KALU | 403



LED
KALU | 403



LED
KALU | 403



SCKET
KALU | 405



SCKET
KALU | 405



SCKET
KALU | 405



SCKET
KALU | 405



LED
KALU TRACK | 520



SCKET
KALU TRACK | 520



LED
KALU TRACK
LED | 558



SCKET
KALU TRACK | 558



KARDAMOD



SCKET

KARDAMOD | 265



SCKET

KARDAMOD | 265

KARPO



LED

KARPO 30 | 232



LED

KARPO MAGN | 382



LED

KARPO GOOSE | 382



LED

KARPO 30 | 383



LED

KARPO | 383



LED

KARPO 30 | 399



LED

KARPO | 452



LED

KARPO | 452

LALU®



NEW

LED

LALU® | 177



NEW

LED

LALU® | 177



NEW

LALU® TETRA 14 | 178



NEW

LALU® TETRA 24 | 178



NEW

LALU® TETRA 36 | 178



NEW

LALU® CONE 15 | 178



NEW

LALU® ELYPSE 15 | 178



NEW

LALU® ELYPSE 22 | 178



NEW

LALU® ELYPSE 33 | 178



NEW

LALU® PLATE 15 | 178



NEW

LALU® PLATE 22 | 178



NEW

SCKET

LALU® | 183

LID



LED
LID I 75 | 611

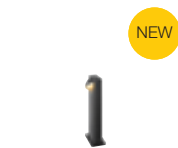

LED
LID I 45 | 611

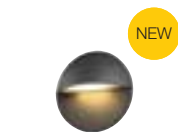

LED
LID II | 711

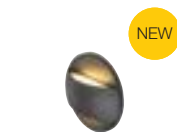

LED
LID II | 711



LED
LID I | 713



LED
LID I | 713

LIGHT EYE



SCKET
LIGHT EYE® 90 | 314



SCKET
LIGHT EYE® 150 | 314



SCKET
LIGHT EYE® 90 | 511



SCKET
LIGHT EYE® 150 | 511

LIPSY



LED
LIPSY® 30 | 423



LED
LIPSY® 40 | 423



LED
LIPSY® 50 | 423



LED
LIPSY® 30 | 425



LED
LIPSY® 40 | 425



LED
LIPSY® 50 | 425



LED
LIPSY® 40 | 426



LED
LIPSY® 50 | 426



LISENNE



SOCKET
LISENNE | 306



SOCKET
LISENNE | 375



SOCKET
LISENNE 40/70 | 662

L-LINE



LED
L-LINE 60 | 341



LED
L-LINE 120 | 341



LED
L-LINE OUT 30 | 650



LED
L-LINE OUT 60 | 651



LED
L-LINE
OUT 50/80 | 651



LED
L-LINE OUT | 775

LOGS



LED
LOGS IN | 362



LED
LOGS IN | 362



LED
LOGS IN L | 363



LED
LOGS IN L | 363



LED
LOGS 40/70 | 633



LED
LOGS | 775

MAGANDA



LED
MAGANDA | 337



LED
MAGANDA | 453

MEDO® PRO 40
1006414 (DC)

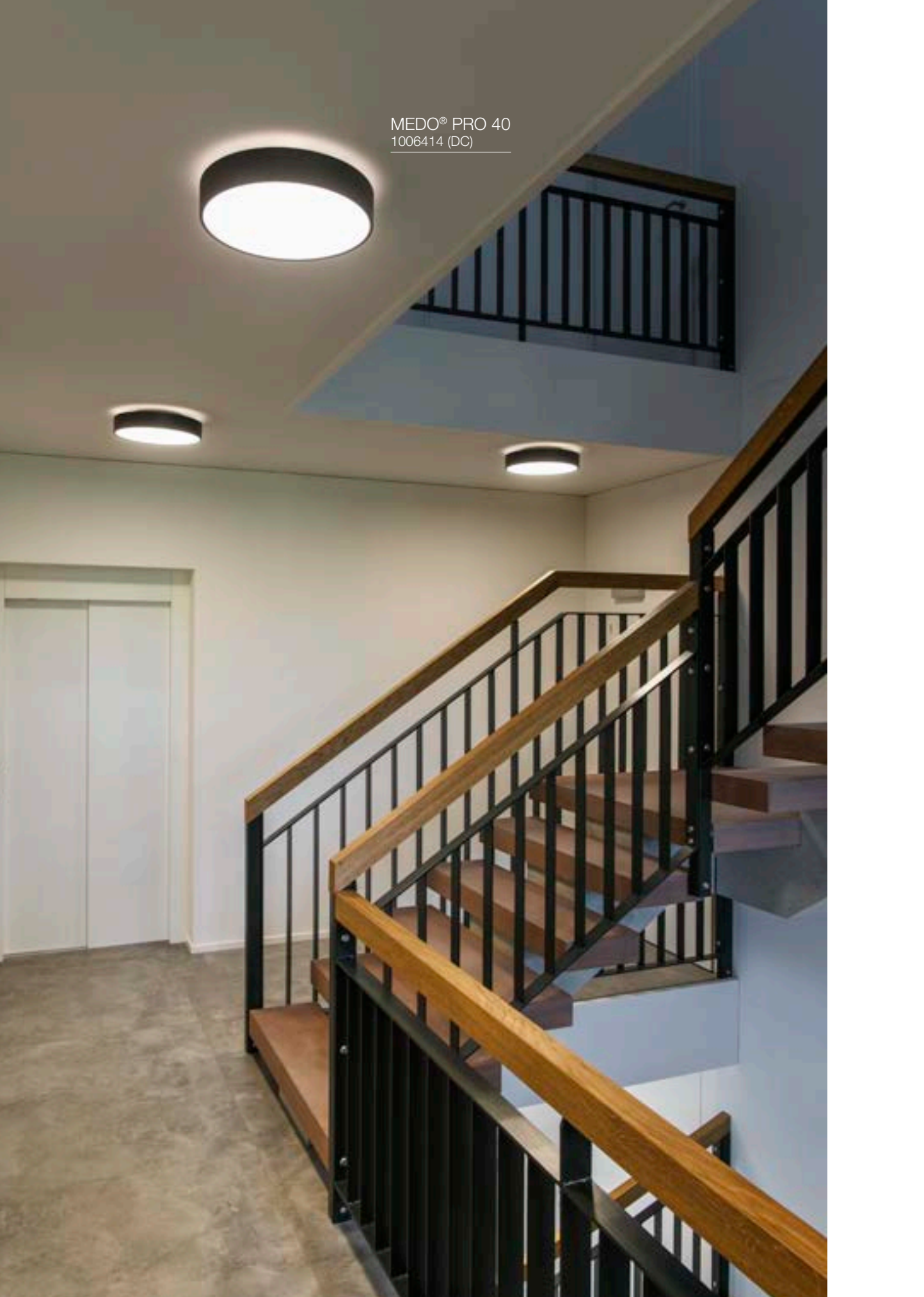



MANA



LED
MANA
BASE | 349, 720



MANA BASE | 349



MANA 40 | 319



MANA 60 | 349



LED
MANA | 351



MANA | 351



MANA | 351



LED
MANA | 353



LED
MANA | 353



MANA | 353

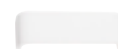

MANA | 353



RUSTY® MANA | 720



RUSTY® MANA | 720



LED
MANA OUT | 721



LED
MANA OUT | 721

MEDO



LED
MEDO® PRO
30 | 150, 152, 157



LED
MEDO® PRO
40 | 150, 152, 157



LED
MEDO® PRO
60 | 151, 153, 157



LED
MEDO® PRO
90 | 151, 153, 157



LED
MEDO® 30 | 161



LED
MEDO® 40 | 161



LED
MEDO® 60 | 161



LED
MEDO® 90 | 161

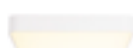

LED
MEDO® 60 | 165



LED
MEDO® RING 60 | 167



LED
MEDO® RING 90 | 167



LED
MEDO® 30 | 170



LED
MEDO® 40 | 170



LED
MEDO® 60 | 170



LED
MEDO® 30 | 171



LED
MEDO® 40 | 171



LED
MEDO® 60 | 171

MERIDIAN



SCKET

MERIDIAN | 746



SCKET

MERIDIAN BOX | 746



SCKET

MERIDIAN BOX
SENSOR | 747



SCKET

MERIDIAN BOX | 747

MOLAT



SCKET

MOLAT | 661



SCKET

MOLAT | 661



SCKET

MOLAT | 777



SCKET

MOLAT | 799

M-POL



LED

M-POL S | 614



LED

M-POL S | 615



LED

M-POL S | 616



LED

M-POL S | 617



LED

M-POL S | 618



LED

M-POL M | 619



LED

M-POL M | 620



LED

M-POL M | 621



M-POL 30/60/90 | 623



MYRA



SCKET

MYRA SPOT | 685



SCKET

MYRA
UP/DOWN | 764



SCKET

MYRA | 811

NAUTILUS



SCKET

NAUTILUS 10 | 694



SCKET

BIG NAUTILUS | 694



SCKET

NAUTILUS 10 | 695



LED

NAUTILUS 10 | 696



SCKET

NAUTILUS | 697



SCKET

NAUTILUS 10
SPOT | 697



LED

NAUTILUS 10
SPOT LED | 697



SCKET

NAUTILUS | 785

NEW TRIA®

NEW



LED

NEW TRIA®
68 | 134, 135

NEW



LED

NEW TRIA®
68 | 134, 135

NEW



LED

NEW TRIA® UNIVERSAL
68 | 136, 137

NEW



LED

NEW TRIA® UNIVERSAL
68 | 136, 137

NEW



LED

NEW TRIA® 75 | 137

NEW



LED

NEW TRIA® 68 | 138

NEW



LED

NEW TRIA® 68 | 138

NEW



LED

NEW TRIA® 75 | 138

NEW



LED

NEW TRIA® 75 | 138

NEW



LED

NEW TRIA® 75 XL | 139

NEW



LED

NEW TRIA® 75 XL | 139

NEW TRIA®



LED
NEW TRIA® 45 | 141



LED
NEW TRIA® 155 | 141



LED
NEW TRIA® 150 | 145



LED
NEW TRIA® 150 | 145



LED
NEW TRIA® 155 | 145



LED
NEW TRIA® 300 | 145

NOBLO®



LED
NOBLO® | 401



LED
NOBLO® | 401



LED
NOBLO® | 401



LED
NOBLO® SPOT | 491



LED
NOBLO® SPOT | 501



LED
NOBLO® SPOT | 501



LED
NOBLO® SPOT | 503



LED
NOBLO® SPOT | 503



LED
NOBLO® SPOT | 545



LED
NOBLO® SPOT | 545



LED
NOBLO® SPOT | 547



LED
NOBLO® SPOT | 547

NUMINOS®



LED
NUMINOS® XS | 84



LED
NUMINOS® S | 84



LED
NUMINOS® M | 85



LED
NUMINOS® L | 85



LED
NUMINOS® XL | 85



LED
NUMINOS® MOVE
XS | 86



LED
NUMINOS® MOVE
S | 86



LED
NUMINOS® MOVE
M | 87



LED
NUMINOS® MOVE
L | 87



LED
NUMINOS® MOVE
XL | 87



NUMINOS® GIMBLE XS | 88



NUMINOS® GIMBLE S | 88



NUMINOS® GIMBLE M | 89



NUMINOS® GIMBLE L | 89



NUMINOS® GIMBLE XL | 89



NEW



NUMINOS® PROJECTOR XS | 92



NEW



NUMINOS® PROJECTOR S | 92



NEW



NUMINOS® PROJECTOR M | 93



NEW



NUMINOS® PROJECTOR XL | 93



NUMINOS® S | 100



NUMINOS® M | 100



NUMINOS® L | 101



NUMINOS® XL | 101



NUMINOS® S | 104



NUMINOS® M | 104



NUMINOS® L | 105



NUMINOS® XL | 105



NUMINOS® S | 108



NUMINOS® M | 108



NUMINOS® L | 109



NUMINOS® XL | 109



NUMINOS® S | 112



NUMINOS® M | 112



NUMINOS® L | 113



NUMINOS® XL | 113



NUMINOS® ZOOM M | 115



NEW



NUMINOS® 48V XS | 468



NEW



NUMINOS® 48V S | 468



NEW



NUMINOS® 48V XS | 470



NEW



NUMINOS® 48V S | 470

OCCULDAS



LED
OCCULDAS 14 | 230



LED
OCCULDAS 23 | 230



LED
OCCULDAS 13 | 262



LED
OCCULDAS 23 | 262

OCULUS



LED
OCULUS | 229



LED
OCULUS | 258



LED
OCULUS | 294



NEW

LED
OCULUS | 355

ONE®



LED
ONE® 60 | 188



LED
ONE® 60 | 188



LED
ONE® 80 | 188



LED
ONE® 80 | 188



LED
ONE® DOUBLE | 189



LED
ONE® TRIPLE | 189



NEW

LED
ONE® CUBE | 189



NEW

LED
ONE® CUBE | 189



LED
ONE® LINEAR 100 | 191



LED
ONE® LINEAR 140 | 191



LED
ONE® 40 | 193



LED
ONE® 60 | 193



LED
ONE® 40 TRACK | 194

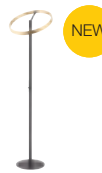

NEW

LED
ONE® STRAIGHT | 196



NEW

LED
ONE® BOW | 197



OVALISK



LED
OVALISK 75/100 | 653



LED
OVALISK
SENSOR | 757



LED
OVALISK | 757



LED
OVALISK | 797

PANEL



LED
LED PANEL | 243



LED
PANEL 60 | 274



LED
PANEL | 275



LED
PANEL 60 | 275



LED
PANEL | 275



LED
PANEL 60 | 289



LED
PANEL TRACK | 507



LED
PANEL TRACK | 507

PANTILO



SCKET
PANTILO
ROPE 19 | 279



SCKET
PANTILO
ROPE 20 | 279



SCKET
PANTILO
ROPE 27 | 279



SCKET
PANTILO
OVAL | 281



SCKET
PANTILO 20 | 281



SCKET
PANTILO 28 | 281



SCKET
PANTILO
CONVEX 29/40 | 283



SCKET
PANTILO
ROPE | 345



SCKET
PANTILO
ROPE 19 | 393

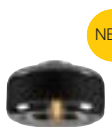

SCKET
PANTILO
ROPE 27 | 393



SCKET
PANTILO
ROPE 19 | 505



SCKET
PANTILO
ROPE 19 | 549

PARA



SCKET

PARA DOME | 318



PARA DOME | 318



PARA DOME | 318



SCKET

PARA 380 | 319

PARA CONE



SCKET

PARA CONE GL | 309



SCKET

PARA CONE 20 | 309



SCKET

PARA CONE 30 | 309



SCKET

PARA CONE GL | 508



SCKET

PARA CONE GL | 508



SCKET

PARA CONE 14 | 509



SCKET

PARA CONE 14 | 509



SCKET

PARA CONE GL | 552



SCKET

PARA CONE GL | 552



SCKET

PARA CONE 14 | 553



SCKET

PARA CONE 14 | 553

PATTA



LED

PATTA-I | 244



LED

PATTA-I | 244



LED

PATTA-I | 245



LED

PATTA-I | 245



LED

PATTA-F | 246



LED

PATTA-F | 247



PEMA



LED
PEMA® | 758



LED
PEMA® | 759



LED
PEMA® | 759



SCKET
PEMA® | 759

PHELIA



SCKET
PHELIA 10 | 310



SCKET
PHELIA 20 | 311



SCKET
PHELIA 25 | 311



SCKET
PHELIA 30 | 311



SCKET
PHELIA | 388



SCKET
PHELIA | 453

PHOTONI



SCKET
PHOTONI 45/75 | 605



SCKET
PHOTONI | 709

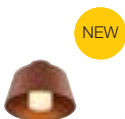

SCKET
PHOTONI | 789

PHOTONIA



SCKET
PHOTONIA | 659



SCKET
PHOTONIA | 659



SCKET
PHOTONIA | 777



SCKET
PHOTONIA | 799

PIKA



SCKET

PIKA | 228



SCKET

PIKA | 228

PLASTRA



SCKET

PLASTRA | 233



SCKET

PLASTRA | 233



SCKET

PLASTRA | 270



LED

PLASTRA | 271



SCKET

PLASTRA 105 | 271



SCKET

PLASTRA 104 | 271



SCKET

PLASTRA | 356



SCKET

PLASTRA | 356



SCKET

PLASTRA | 357



SCKET

PLASTRA | 357



SCKET

PLASTRA | 359



LED

PLASTRA | 359



LED

PLASTRA | 359



SCKET

PLASTRA | 360



SCKET

PLASTRA 101 | 361



SCKET

PLASTRA | 361



SCKET

PLASTRA 104 | 361

POWER TRAIL-LITE



LED

POWER TRAIL-LITE® | 849



LED

POWER TRAIL-LITE® | 849



PURI



SCKET
PURI | 411



SCKET
PURI | 411



SCKET
PURI | 411



SCKET
PURI | 411



SCKET
PURI TRACK | 513



SCKET
PURI TRACK | 513



SCKET
PURI TRACK | 515



SCKET
PURI TRACK | 557



SCKET
PURI TRACK
GLASS | 557

Q-LINE®



LED
Q-LINE® | 253



LED
Q-LINE® | 253



LED
Q-LINE® | 293



LED
Q-LINE® | 293



LED
Q-LINE® | 293



LED
Q-LINE® | 341

QUAD



LED
QUAD FRAME 9 | 240



LED
QUAD FRAME 14 | 364



LED
QUAD FRAME 19 | 364



LED
BIG QUAD | 752



LED
QUAD | 752



LED
QUAD
UP/DOWN 15 | 753



LED
BIG QUAD
UP/DOWN | 755



LED
BIG QUAD | 755

QUADRASS



SCKET

QUADRASS | 307



SCKET

QUADRASS | 375



LED

QUADRASS
SPOT | 375

QUADRASYL



SCKET

QUADRASYL 75 | 682



SCKET

QUADRASYL | 781

QUADRULO



LED

QUADRULO | 639



NEW

LED

QUADRULO | 744



SCKET

QUADRULO
SENSOR | 745



SCKET

QUADRULO | 745



LED

QUADRULO | 811

RASCALI



LED

RASCALI 45/65 | 684



LED

RASCALI | 780



ROCCI



LED

ROCCI | 854



LED

ROCCI | 854



LED

ROCCI 200 | 855



LED

ROCCI 200 | 855

ROTBALL



SCKET

ROTBALL 25 | 317



SCKET

ROTBALL 40 | 317



SCKET

ROTBALL 50 | 317



SCKET

ROTBALL
25/40/50 | 657

ROX



SCKET

ROX ACRYL
30/60/90 | 669



SCKET

ROX UP/DOWN | 767



SCKET

ROX | 767



SCKET

ROX | 801



SCKET

ROX | 801

RUSTY®



LED
RUSTY®
SLOT 50/80 | 640



SOCKET
RUSTY®
SLOT 50/80 | 641



SOCKET
RUSTY®
PATHLIGHT | 642



LED
RUSTY® 40/70 | 643



SOCKET
RUSTY® 40/70 | 643



SOCKET
RUSTY®
CONE 24 | 645



SOCKET
RUSTY®
CONE 40/70 | 645



SOCKET
RUSTY® 40/70 | 646



RUSTY® MANA | 720



RUSTY® MANA | 720



LED
RUSTY®
UP/DOWN | 756



LED
RUSTY®
UP/DOWN | 756

SENDER



LED
SENDER 12 | 223



LED
SENDER 18 | 223



LED
SENDER 24 | 223



LED
SENDER 12 | 225



LED
SENDER 18 | 225

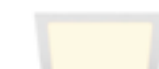

LED
SENDER 24 | 225



LED
SENDER 12 | 417



LED
SENDER 18 | 417



LED
SENDER 24 | 417



LED
SENDER 12 | 419



LED
SENDER 18 | 419



LED
SENDER 24 | 419

SIGHT



LED
SIGHT 60 | 431



LED
SIGHT 115 | 431



LED
SIGHT TRACK | 550



LED
SIGHT TRACK | 550



LED
SIGHT MOVE | 551



LED
SIGHT MOVE | 551



SIMA



LED

SIMA | 420



LED

SIMA | 420



LED

SIMA | 421



LED

SIMA | 421

SITRA



SCKET

SITRA 360 | 685



SCKET

SITRA 360 SPIKE | 703



SCKET

SITRA 360 SPIKE | 703



LED

SITRA S | 739



LED

SITRA S | 739



LED

SITRA M | 741



LED

SITRA L | 741



SCKET

SITRA CUBE | 741



SCKET

SITRA | 801



SCKET

SITRA 360 | 808



LED

SITRA UP/DOWN | 765



SCKET

SITRA UP/DOWN | 765

SLOTS



LED

SLOTS 45/65 | 675



LED

SLOTS | 768

SOLASTO



SCKET

SOLASTO | 857



SCKET

SOLASTO | 857

SOMNILA



LED

SOMNILA SPOT | 384



LED

SOMNILA SPOT | 385



LED

SOMNILA FLEX | 385



LED

SOMNILA FLEX | 385

SQUARE



SCKET

SQUARE
POLE 30/60/90 | 673



SCKET

SQUARE | 779



SCKET

SQUARE TURN | 781

S-TUBE



SCKET

S-TUBE 32/75 | 603



SCKET

S-TUBE | 805



SUN



SCKET

SUN / BIG SUN | 315



NEW

SCKET

TINY SUN | 443



NEW

SCKET

LITTLE SUN | 443

SYNA



NEW

LED

SYNA PLANT | 689



NEW

LED

SYNA GARDEN | 689



LED

SYNA | 689

THEO



SCKET

THEO UP/DOWN | 377



SCKET

THEO PATHLIGHT | 652



SCKET

THEO BRACKET | 701



SCKET

THEO UP/DOWN | 735



LED

BIG THEO BEAM UP/
FLOOD DOWN | 735



SCKET

BIG THEO UP/DOWN | 735



LED

BIG THEO FLOOD UP/DOWN | 736



SCKET

THEO | 736



SCKET

BIG THEO | 737



LED

BIG THEO | 737



LED

BIG THEO | 797



SCKET

BIG THEO | 797



SCKET

THEO BRACKET | 808

TRILEDO



SOCKET

TRILEDO | 255



SOCKET

TRILEDO | 255



SOCKET

TRILEDO | 255



LED

TRILEDO | 257



LED

TRILEDO | 257



LED

TRILEDO | 257

TRUKKO



LED

TRUKKO | 330



LED

TRUKKO | 330



NEW

LED

TRUKKO | 331



NEW

LED

TRUKKO 80 | 331



LED

TRUKKO 60 | 332



LED

TRUKKO 90 | 332

UNIVERSAL DOWNLIGHT



NEW

LED

UNIVERSAL
DOWNLIGHT | 205



NEW

LED

UNIVERSAL
DOWNLIGHT | 207



NEW

LED

UNIVERSAL
DOWNLIGHT | 208



NEW

LED

UNIVERSAL
DOWNLIGHT | 209

VILUA



LED

VILUA S | 763



LED

VILUA L | 763



LED

VILUA | 763



VINOLINA



LED
VINOLINA
ONE | 437, 597



LED
VINOLINA |
437,597



LED
VINOLINA
TWO | 439, 599

WL



LED
WL 149 | 334



SOCKET
WL 149 | 334



SOCKET
WL 106 | 335



SOCKET
WL 106 | 335

WORKLIGHT



LED
WORKLIGHT
PRO 120 | 287



LED
WORKLIGHT
PRO 150 | 287



LED
WORKLIGHT
PRO | 444



LED
WORKLIGHT
PRO | 444



LED
WORKLIGHT | 445



LED
WORKLIGHT | 445

NUMINOS® GIMBLE
1005817



Découvrez le
configurateur
NUMINOS®
sur [slv.com](https://www.slv.com)

NUMINOS®
Downlights (DL)



Vous pouvez choisir
vos NUMINOS® DL
dans de nombreux
coloris



noir - noir



noir - blanc



noir - chrome



blanc - noir



blanc - blanc



blanc - chrome



NUMINOS® GIMBLE
Orientable à 355° et
inclinable à 60°



NUMINOS® MOVE
Orientable à 355° et
inclinable à 30°



Fiche basse tension

XS 200mA Puissance totale : 7W Matière : aluminium / polycarbonate (PC)
S 250mA Puissance totale : 8,6W Matière : aluminium / polycarbonate (PC)

2700K	20°	640lm	1005499	75.00 CHF	670lm	1003769	79.00 CHF
	40°	620lm	1005502	75.00 CHF	670lm	1003772	79.00 CHF
	55°	640lm	1005505	75.00 CHF	670lm	1003775	79.00 CHF
3000K	20°	700lm	1005517	75.00 CHF	690lm	1003793	79.00 CHF
	40°	670lm	1005520	75.00 CHF	690lm	1003796	79.00 CHF
	55°	690lm	1005523	75.00 CHF	690lm	1003799	79.00 CHF
4000K	20°	720lm	1005535	75.00 CHF	730lm	1003817	79.00 CHF
	40°	700lm	1005538	75.00 CHF	730lm	1003820	79.00 CHF
	55°	710lm	1005541	75.00 CHF	730lm	1003823	79.00 CHF
2700K	20°	670lm	1005500	75.00 CHF	720lm	1003770	79.00 CHF
	40°	650lm	1005503	75.00 CHF	720lm	1003773	79.00 CHF
	55°	670lm	1005506	75.00 CHF	720lm	1003776	79.00 CHF
3000K	20°	730lm	1005518	75.00 CHF	730lm	1003794	79.00 CHF
	40°	700lm	1005521	75.00 CHF	730lm	1003797	79.00 CHF
	55°	720lm	1005524	75.00 CHF	730lm	1003800	79.00 CHF
4000K	20°	750lm	1005536	75.00 CHF	790lm	1003818	79.00 CHF
	40°	730lm	1005539	75.00 CHF	790lm	1003821	79.00 CHF
	55°	740lm	1005542	75.00 CHF	790lm	1003824	79.00 CHF
2700K	20°	670lm	1005501	75.00 CHF	690lm	1003771	79.00 CHF
	40°	650lm	1005504	75.00 CHF	690lm	1003774	79.00 CHF
	55°	670lm	1005507	75.00 CHF	690lm	1003777	79.00 CHF
3000K	20°	730lm	1005519	75.00 CHF	700lm	1003795	79.00 CHF
	40°	700lm	1005522	75.00 CHF	700lm	1003798	79.00 CHF
	55°	720lm	1005525	75.00 CHF	700lm	1003801	79.00 CHF
4000K	20°	750lm	1005537	75.00 CHF	750lm	1003819	79.00 CHF
	40°	730lm	1005540	75.00 CHF	750lm	1003822	79.00 CHF
	55°	740lm	1005543	75.00 CHF	750lm	1003825	79.00 CHF
2700K	20°	640lm	1005508	75.00 CHF	670lm	1003781	79.00 CHF
	40°	620lm	1005511	75.00 CHF	670lm	1003784	79.00 CHF
	55°	640lm	1005514	75.00 CHF	670lm	1003787	79.00 CHF
3000K	20°	700lm	1005526	75.00 CHF	690lm	1003805	79.00 CHF
	40°	670lm	1005529	75.00 CHF	690lm	1003808	79.00 CHF
	55°	690lm	1005532	75.00 CHF	690lm	1003811	79.00 CHF
4000K	20°	720lm	1005544	75.00 CHF	730lm	1003829	79.00 CHF
	40°	700lm	1005547	75.00 CHF	730lm	1003832	79.00 CHF
	55°	710lm	1005550	75.00 CHF	730lm	1003835	79.00 CHF
2700K	20°	670lm	1005509	75.00 CHF	720lm	1003782	79.00 CHF
	40°	650lm	1005512	75.00 CHF	720lm	1003785	79.00 CHF
	55°	670lm	1005515	75.00 CHF	720lm	1003788	79.00 CHF
3000K	20°	730lm	1005527	75.00 CHF	730lm	1003806	79.00 CHF
	40°	700lm	1005530	75.00 CHF	730lm	1003809	79.00 CHF
	55°	720lm	1005533	75.00 CHF	730lm	1003812	79.00 CHF
4000K	20°	750lm	1005545	75.00 CHF	790lm	1003830	79.00 CHF
	40°	730lm	1005548	75.00 CHF	790lm	1003833	79.00 CHF
	55°	740lm	1005551	75.00 CHF	790lm	1003836	79.00 CHF
2700K	20°	670lm	1005510	75.00 CHF	690lm	1003783	79.00 CHF
	40°	650lm	1005513	75.00 CHF	690lm	1003786	79.00 CHF
	55°	670lm	1005516	75.00 CHF	690lm	1003789	79.00 CHF
3000K	20°	730lm	1005528	75.00 CHF	700lm	1003807	79.00 CHF
	40°	700lm	1005531	75.00 CHF	700lm	1003810	79.00 CHF
	55°	720lm	1005534	75.00 CHF	700lm	1003813	79.00 CHF
4000K	20°	750lm	1005546	75.00 CHF	750lm	1003831	79.00 CHF
	40°	730lm	1005549	75.00 CHF	750lm	1003834	79.00 CHF
	55°	740lm	1005552	75.00 CHF	750lm	1003837	79.00 CHF



M	500mA Puissance totale : 17,5W Matière : aluminium / polycarbonate (PC)	L	700mA Puissance totale : 25,4W Matière : aluminium / polycarbonate (PC)	XL	1050mA Puissance totale : 37,4W Matière : aluminium / polycarbonate (PC)
----------	---	----------	---	-----------	--

	2700K	20°	1460lm	1003841	99.00 CHF	2150lm	1003913	125.00 CHF	3300lm	1003985	155.00 CHF
		40°	1460lm	1003844	99.00 CHF	2150lm	1003916	125.00 CHF	3300lm	1003988	155.00 CHF
		55°	1460lm	1003847	99.00 CHF	2150lm	1003919	125.00 CHF	3300lm	1003991	155.00 CHF
	3000K	20°	1500lm	1003865	99.00 CHF	2150lm	1003937	125.00 CHF	3300lm	1004009	155.00 CHF
		40°	1500lm	1003868	99.00 CHF	2150lm	1003940	125.00 CHF	3300lm	1004012	155.00 CHF
		55°	1500lm	1003871	99.00 CHF	2150lm	1003943	125.00 CHF	3300lm	1004015	155.00 CHF
	4000K	20°	1600lm	1003889	99.00 CHF	2350lm	1003961	125.00 CHF	3600lm	1004033	155.00 CHF
		40°	1600lm	1003892	99.00 CHF	2350lm	1003964	125.00 CHF	3600lm	1004036	155.00 CHF
		55°	1600lm	1003895	99.00 CHF	2350lm	1003967	125.00 CHF	3600lm	1004039	155.00 CHF
	2700K	20°	1600lm	1003842	99.00 CHF	2250lm	1003914	125.00 CHF	3500lm	1003986	155.00 CHF
		40°	1600lm	1003845	99.00 CHF	2250lm	1003917	125.00 CHF	3500lm	1003989	155.00 CHF
		55°	1600lm	1003848	99.00 CHF	2250lm	1003920	125.00 CHF	3500lm	1003992	155.00 CHF
	3000K	20°	1600lm	1003866	99.00 CHF	2300lm	1003938	125.00 CHF	3550lm	1004010	155.00 CHF
		40°	1600lm	1003869	99.00 CHF	2300lm	1003941	125.00 CHF	3550lm	1004013	155.00 CHF
		55°	1600lm	1003872	99.00 CHF	2300lm	1003944	125.00 CHF	3550lm	1004016	155.00 CHF
	4000K	20°	1750lm	1003890	99.00 CHF	2450lm	1003962	125.00 CHF	3800lm	1004034	155.00 CHF
		40°	1750lm	1003893	99.00 CHF	2450lm	1003965	125.00 CHF	3800lm	1004037	155.00 CHF
		55°	1750lm	1003896	99.00 CHF	2450lm	1003968	125.00 CHF	3800lm	1004040	155.00 CHF
	2700K	20°	1550lm	1003843	99.00 CHF	2150lm	1003915	125.00 CHF	3400lm	1003987	155.00 CHF
		40°	1550lm	1003846	99.00 CHF	2150lm	1003918	125.00 CHF	3400lm	1003990	155.00 CHF
		55°	1550lm	1003849	99.00 CHF	2150lm	1003921	125.00 CHF	3400lm	1003993	155.00 CHF
	3000K	20°	1550lm	1003867	99.00 CHF	2200lm	1003939	125.00 CHF	3500lm	1004011	155.00 CHF
		40°	1550lm	1003870	99.00 CHF	2200lm	1003942	125.00 CHF	3500lm	1004014	155.00 CHF
		55°	1550lm	1003873	99.00 CHF	2200lm	1003945	125.00 CHF	3500lm	1004017	155.00 CHF
	4000K	20°	1660lm	1003891	99.00 CHF	2350lm	1003963	125.00 CHF	3750lm	1004035	155.00 CHF
		40°	1660lm	1003894	99.00 CHF	2350lm	1003966	125.00 CHF	3750lm	1004038	155.00 CHF
		55°	1660lm	1003897	99.00 CHF	2350lm	1003969	125.00 CHF	3750lm	1004041	155.00 CHF
	2700K	20°	1460lm	1003853	99.00 CHF	2150lm	1003925	125.00 CHF	3300lm	1003997	155.00 CHF
		40°	1460lm	1003856	99.00 CHF	2150lm	1003928	125.00 CHF	3300lm	1004000	155.00 CHF
		55°	1460lm	1003859	99.00 CHF	2150lm	1003931	125.00 CHF	3300lm	1004003	155.00 CHF
	3000K	20°	1500lm	1003877	99.00 CHF	2150lm	1003949	125.00 CHF	3300lm	1004021	155.00 CHF
		40°	1500lm	1003880	99.00 CHF	2150lm	1003952	125.00 CHF	3300lm	1004024	155.00 CHF
		55°	1500lm	1003883	99.00 CHF	2150lm	1003955	125.00 CHF	3300lm	1004027	155.00 CHF
	4000K	20°	1600lm	1003901	99.00 CHF	2350lm	1003973	125.00 CHF	3600lm	1004045	155.00 CHF
		40°	1600lm	1003904	99.00 CHF	2350lm	1003976	125.00 CHF	3600lm	1004048	155.00 CHF
		55°	1600lm	1003907	99.00 CHF	2350lm	1003979	125.00 CHF	3600lm	1004051	155.00 CHF
	2700K	20°	1600lm	1003854	99.00 CHF	2250lm	1003926	125.00 CHF	3500lm	1003998	155.00 CHF
		40°	1600lm	1003857	99.00 CHF	2250lm	1003929	125.00 CHF	3500lm	1004001	155.00 CHF
		55°	1600lm	1003860	99.00 CHF	2250lm	1003932	125.00 CHF	3500lm	1004004	155.00 CHF
	3000K	20°	1600lm	1003878	99.00 CHF	2300lm	1003950	125.00 CHF	3550lm	1004022	155.00 CHF
		40°	1600lm	1003881	99.00 CHF	2300lm	1003953	125.00 CHF	3550lm	1004025	155.00 CHF
		55°	1600lm	1003884	99.00 CHF	2300lm	1003956	125.00 CHF	3550lm	1004028	155.00 CHF
	4000K	20°	1750lm	1003902	99.00 CHF	2450lm	1003974	125.00 CHF	3800lm	1004046	155.00 CHF
		40°	1750lm	1003905	99.00 CHF	2450lm	1003977	125.00 CHF	3800lm	1004049	155.00 CHF
		55°	1750lm	1003908	99.00 CHF	2450lm	1003980	125.00 CHF	3800lm	1004052	155.00 CHF
	2700K	20°	1550lm	1003855	99.00 CHF	2150lm	1003927	125.00 CHF	3400lm	1003999	155.00 CHF
		40°	1550lm	1003858	99.00 CHF	2150lm	1003930	125.00 CHF	3400lm	1004002	155.00 CHF
		55°	1550lm	1003861	99.00 CHF	2150lm	1003933	125.00 CHF	3400lm	1004005	155.00 CHF
	3000K	20°	1550lm	1003879	99.00 CHF	2200lm	1003951	125.00 CHF	3500lm	1004023	155.00 CHF
		40°	1550lm	1003882	99.00 CHF	2200lm	1003954	125.00 CHF	3500lm	1004026	155.00 CHF
		55°	1550lm	1003885	99.00 CHF	2200lm	1003957	125.00 CHF	3500lm	1004029	155.00 CHF
	4000K	20°	1660lm	1003903	99.00 CHF	2350lm	1003975	125.00 CHF	3750lm	1004047	155.00 CHF
		40°	1660lm	1003906	99.00 CHF	2350lm	1003978	125.00 CHF	3750lm	1004050	155.00 CHF
		55°	1660lm	1003909	99.00 CHF	2350lm	1003981	125.00 CHF	3750lm	1004053	155.00 CHF

NUMINOS® MOVE DL



Fiche basse tension

XS 200mA
Puissance totale : 7W
Matière : aluminium / polycarbonate (PC)

S 250mA
Puissance totale : 8,6W
Matière : aluminium / polycarbonate (PC)

2700K	20°	640lm	1005553	109.00 CHF	670lm	1005319	117.00 CHF
	40°	620lm	1005556	109.00 CHF	670lm	1005322	117.00 CHF
	55°	640lm	1005559	109.00 CHF	670lm	1005325	117.00 CHF
3000K	20°	700lm	1005571	109.00 CHF	690lm	1005337	117.00 CHF
	40°	670lm	1005574	109.00 CHF	690lm	1005340	117.00 CHF
	55°	690lm	1005577	109.00 CHF	690lm	1005343	117.00 CHF
4000K	20°	720lm	1005589	109.00 CHF	730lm	1005355	117.00 CHF
	40°	700lm	1005592	109.00 CHF	730lm	1005358	117.00 CHF
	55°	710lm	1005595	109.00 CHF	730lm	1005361	117.00 CHF
2700K	20°	670lm	1005554	109.00 CHF	720lm	1005320	117.00 CHF
	40°	650lm	1005557	109.00 CHF	720lm	1005323	117.00 CHF
	55°	670lm	1005560	109.00 CHF	720lm	1005326	117.00 CHF
3000K	20°	730lm	1005572	109.00 CHF	730lm	1005338	117.00 CHF
	40°	700lm	1005575	109.00 CHF	730lm	1005341	117.00 CHF
	55°	720lm	1005578	109.00 CHF	730lm	1005344	117.00 CHF
4000K	20°	750lm	1005590	109.00 CHF	790lm	1005356	117.00 CHF
	40°	730lm	1005593	109.00 CHF	790lm	1005359	117.00 CHF
	55°	740lm	1005596	109.00 CHF	790lm	1005362	117.00 CHF
2700K	20°	670lm	1005555	109.00 CHF	690lm	1005321	117.00 CHF
	40°	650lm	1005558	109.00 CHF	690lm	1005324	117.00 CHF
	55°	670lm	1005561	109.00 CHF	690lm	1005327	117.00 CHF
3000K	20°	730lm	1005573	109.00 CHF	700lm	1005339	117.00 CHF
	40°	700lm	1005576	109.00 CHF	700lm	1005342	117.00 CHF
	55°	720lm	1005579	109.00 CHF	700lm	1005345	117.00 CHF
4000K	20°	750lm	1005591	109.00 CHF	750lm	1005357	117.00 CHF
	40°	730lm	1005594	109.00 CHF	750lm	1005360	117.00 CHF
	55°	740lm	1005597	109.00 CHF	750lm	1005363	117.00 CHF
2700K	20°	640lm	1005562	109.00 CHF	670lm	1005328	117.00 CHF
	40°	620lm	1005565	109.00 CHF	670lm	1005331	117.00 CHF
	55°	640lm	1005568	109.00 CHF	670lm	1005334	117.00 CHF
3000K	20°	700lm	1005580	109.00 CHF	690lm	1005346	117.00 CHF
	40°	670lm	1005583	109.00 CHF	690lm	1005349	117.00 CHF
	55°	690lm	1005586	109.00 CHF	690lm	1005352	117.00 CHF
4000K	20°	720lm	1005598	109.00 CHF	730lm	1005364	117.00 CHF
	40°	700lm	1005603	109.00 CHF	730lm	1005367	117.00 CHF
	55°	710lm	1005606	109.00 CHF	730lm	1005370	117.00 CHF
2700K	20°	670lm	1005563	109.00 CHF	720lm	1005329	117.00 CHF
	40°	650lm	1005566	109.00 CHF	720lm	1005332	117.00 CHF
	55°	670lm	1005569	109.00 CHF	720lm	1005335	117.00 CHF
3000K	20°	730lm	1005581	109.00 CHF	730lm	1005347	117.00 CHF
	40°	700lm	1005584	109.00 CHF	730lm	1005350	117.00 CHF
	55°	720lm	1005587	109.00 CHF	730lm	1005353	117.00 CHF
4000K	20°	750lm	1005599	109.00 CHF	790lm	1005365	117.00 CHF
	40°	730lm	1005604	109.00 CHF	790lm	1005368	117.00 CHF
	55°	740lm	1005607	109.00 CHF	790lm	1005371	117.00 CHF
2700K	20°	670lm	1005564	109.00 CHF	690lm	1005330	117.00 CHF
	40°	650lm	1005567	109.00 CHF	690lm	1005333	117.00 CHF
	55°	670lm	1005570	109.00 CHF	690lm	1005336	117.00 CHF
3000K	20°	730lm	1005582	109.00 CHF	700lm	1005348	117.00 CHF
	40°	700lm	1005585	109.00 CHF	700lm	1005351	117.00 CHF
	55°	720lm	1005588	109.00 CHF	700lm	1005354	117.00 CHF
4000K	20°	750lm	1005600	109.00 CHF	750lm	1005366	117.00 CHF
	40°	730lm	1005605	109.00 CHF	750lm	1005369	117.00 CHF
	55°	740lm	1005608	109.00 CHF	750lm	1005372	117.00 CHF



M 500mA Puissance totale : 17,5W Matière : aluminium / polycarbonate (PC)
L 700mA Puissance totale : 25,4W Matière : aluminium / polycarbonate (PC)
XL 1050mA Puissance totale : 37,4W Matière : aluminium / polycarbonate (PC)

2700K	20°	1460lm	1003553	115.00 CHF	2150lm	1003625	135.00 CHF	3300lm	1003697	175.00 CHF
	40°	1460lm	1003556	115.00 CHF	2150lm	1003628	135.00 CHF	3300lm	1003700	175.00 CHF
	55°	1460lm	1003559	115.00 CHF	2150lm	1003631	135.00 CHF	3300lm	1003703	175.00 CHF
3000K	20°	1500lm	1003577	115.00 CHF	2150lm	1003649	135.00 CHF	3300lm	1003721	175.00 CHF
	40°	1500lm	1003580	115.00 CHF	2150lm	1003652	135.00 CHF	3300lm	1003724	175.00 CHF
	55°	1500lm	1003583	115.00 CHF	2150lm	1003655	135.00 CHF	3300lm	1003727	175.00 CHF
4000K	20°	1600lm	1003601	115.00 CHF	2350lm	1003673	135.00 CHF	3600lm	1003745	175.00 CHF
	40°	1600lm	1003604	115.00 CHF	2350lm	1003676	135.00 CHF	3600lm	1003748	175.00 CHF
	55°	1600lm	1003607	115.00 CHF	2350lm	1003679	135.00 CHF	3600lm	1003751	175.00 CHF
2700K	20°	1600lm	1003554	115.00 CHF	2250lm	1003626	135.00 CHF	3500lm	1003698	175.00 CHF
	40°	1600lm	1003557	115.00 CHF	2250lm	1003629	135.00 CHF	3500lm	1003701	175.00 CHF
	55°	1600lm	1003560	115.00 CHF	2250lm	1003632	135.00 CHF	3500lm	1003704	175.00 CHF
3000K	20°	1600lm	1003578	115.00 CHF	2300lm	1003650	135.00 CHF	3550lm	1003722	175.00 CHF
	40°	1600lm	1003581	115.00 CHF	2300lm	1003653	135.00 CHF	3550lm	1003725	175.00 CHF
	55°	1600lm	1003584	115.00 CHF	2300lm	1003656	135.00 CHF	3550lm	1003728	175.00 CHF
4000K	20°	1750lm	1003602	115.00 CHF	2450lm	1003674	135.00 CHF	3800lm	1003746	175.00 CHF
	40°	1750lm	1003605	115.00 CHF	2450lm	1003677	135.00 CHF	3800lm	1003749	175.00 CHF
	55°	1750lm	1003608	115.00 CHF	2450lm	1003680	135.00 CHF	3800lm	1003752	175.00 CHF
2700K	20°	1550lm	1003555	115.00 CHF	2150lm	1003627	135.00 CHF	3400lm	1003699	175.00 CHF
	40°	1550lm	1003558	115.00 CHF	2150lm	1003630	135.00 CHF	3400lm	1003702	175.00 CHF
	55°	1550lm	1003561	115.00 CHF	2150lm	1003633	135.00 CHF	3400lm	1003705	175.00 CHF
3000K	20°	1550lm	1003579	115.00 CHF	2200lm	1003651	135.00 CHF	3500lm	1003723	175.00 CHF
	40°	1550lm	1003582	115.00 CHF	2200lm	1003654	135.00 CHF	3500lm	1003726	175.00 CHF
	55°	1550lm	1003585	115.00 CHF	2200lm	1003657	135.00 CHF	3500lm	1003729	175.00 CHF
4000K	20°	1660lm	1003603	115.00 CHF	2350lm	1003675	135.00 CHF	3750lm	1003747	175.00 CHF
	40°	1660lm	1003606	115.00 CHF	2350lm	1003678	135.00 CHF	3750lm	1003750	175.00 CHF
	55°	1660lm	1003609	115.00 CHF	2350lm	1003681	135.00 CHF	3750lm	1003753	175.00 CHF
2700K	20°	1460lm	1003565	115.00 CHF	2150lm	1003637	135.00 CHF	3300lm	1003709	175.00 CHF
	40°	1460lm	1003568	115.00 CHF	2150lm	1003640	135.00 CHF	3300lm	1003712	175.00 CHF
	55°	1460lm	1003571	115.00 CHF	2150lm	1003643	135.00 CHF	3300lm	1003715	175.00 CHF
3000K	20°	1500lm	1003589	115.00 CHF	2150lm	1003661	135.00 CHF	3300lm	1003733	175.00 CHF
	40°	1500lm	1003592	115.00 CHF	2150lm	1003664	135.00 CHF	3300lm	1003736	175.00 CHF
	55°	1500lm	1003595	115.00 CHF	2150lm	1003667	135.00 CHF	3300lm	1003739	175.00 CHF
4000K	20°	1600lm	1003613	115.00 CHF	2350lm	1003685	135.00 CHF	3600lm	1003757	175.00 CHF
	40°	1600lm	1003616	115.00 CHF	2350lm	1003688	135.00 CHF	3600lm	1003760	175.00 CHF
	55°	1600lm	1003619	115.00 CHF	2350lm	1003691	135.00 CHF	3600lm	1003763	175.00 CHF
2700K	20°	1600lm	1003566	115.00 CHF	2250lm	1003638	135.00 CHF	3500lm	1003710	175.00 CHF
	40°	1600lm	1003569	115.00 CHF	2250lm	1003641	135.00 CHF	3500lm	1003713	175.00 CHF
	55°	1600lm	1003572	115.00 CHF	2250lm	1003644	135.00 CHF	3500lm	1003716	175.00 CHF
3000K	20°	1600lm	1003590	115.00 CHF	2300lm	1003662	135.00 CHF	3550lm	1003734	175.00 CHF
	40°	1600lm	1003593	115.00 CHF	2300lm	1003665	135.00 CHF	3550lm	1003737	175.00 CHF
	55°	1600lm	1003596	115.00 CHF	2300lm	1003668	135.00 CHF	3550lm	1003740	175.00 CHF
4000K	20°	1750lm	1003614	115.00 CHF	2450lm	1003686	135.00 CHF	3800lm	1003758	175.00 CHF
	40°	1750lm	1003617	115.00 CHF	2450lm	1003689	135.00 CHF	3800lm	1003761	175.00 CHF
	55°	1750lm	1003620	115.00 CHF	2450lm	1003692	135.00 CHF	3800lm	1003764	175.00 CHF
2700K	20°	1550lm	1003567	115.00 CHF	2150lm	1003639	135.00 CHF	3400lm	1003711	175.00 CHF
	40°	1550lm	1003570	115.00 CHF	2150lm	1003642	135.00 CHF	3400lm	1003714	175.00 CHF
	55°	1550lm	1003573	115.00 CHF	2150lm	1003645	135.00 CHF	3400lm	1003717	175.00 CHF
3000K	20°	1550lm	1003591	115.00 CHF	2200lm	1003663	135.00 CHF	3500lm	1003735	175.00 CHF
	40°	1550lm	1003594	115.00 CHF	2200lm	1003666	135.00 CHF	3500lm	1003738	175.00 CHF
	55°	1550lm	1003597	115.00 CHF	2200lm	1003669	135.00 CHF	3500lm	1003741	175.00 CHF
4000K	20°	1660lm	1003615	115.00 CHF	2350lm	1003687	135.00 CHF	3750lm	1003759	175.00 CHF
	40°	1660lm	1003618	115.00 CHF	2350lm	1003690	135.00 CHF	3750lm	1003762	175.00 CHF
	55°	1660lm	1003621	115.00 CHF	2350lm	1003693	135.00 CHF	3750lm	1003765	175.00 CHF

NUMINOS® GIMBLE DL

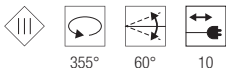

355° 60° 10

Fiche basse tension

XS

200mA
Puissance totale : 7W
Matière : aluminium / polycarbonate (PC)

S

250mA
Puissance totale : 8,6W
Matière : aluminium / polycarbonate (PC)

	2700K	20°	640lm	1005813	117.00 CHF	670lm	1005867	125.00 CHF
		40°	620lm	1005816	117.00 CHF	670lm	1005870	125.00 CHF
		55°	640lm	1005819	117.00 CHF	670lm	1005873	125.00 CHF
	3000K	20°	700lm	1005831	117.00 CHF	690lm	1005885	125.00 CHF
		40°	670lm	1005834	117.00 CHF	690lm	1005888	125.00 CHF
		55°	690lm	1005837	117.00 CHF	690lm	1005891	125.00 CHF
	4000K	20°	720lm	1005849	117.00 CHF	730lm	1005903	125.00 CHF
		40°	700lm	1005852	117.00 CHF	730lm	1005906	125.00 CHF
		55°	710lm	1005855	117.00 CHF	730lm	1005909	125.00 CHF
	2700K	20°	670lm	1005814	117.00 CHF	720lm	1005868	125.00 CHF
		40°	650lm	1005817	117.00 CHF	720lm	1005871	125.00 CHF
		55°	670lm	1005820	117.00 CHF	720lm	1005874	125.00 CHF
	3000K	20°	730lm	1005832	117.00 CHF	730lm	1005886	125.00 CHF
		40°	700lm	1005835	117.00 CHF	730lm	1005889	125.00 CHF
		55°	720lm	1005838	117.00 CHF	730lm	1005892	125.00 CHF
	4000K	20°	750lm	1005850	117.00 CHF	790lm	1005904	125.00 CHF
		40°	730lm	1005853	117.00 CHF	790lm	1005907	125.00 CHF
		55°	740lm	1005856	117.00 CHF	790lm	1005910	125.00 CHF
	2700K	20°	670lm	1005815	117.00 CHF	690lm	1005869	125.00 CHF
		40°	650lm	1005818	117.00 CHF	690lm	1005872	125.00 CHF
		55°	670lm	1005821	117.00 CHF	690lm	1005875	125.00 CHF
	3000K	20°	730lm	1005833	117.00 CHF	700lm	1005887	125.00 CHF
		40°	700lm	1005836	117.00 CHF	700lm	1005890	125.00 CHF
		55°	720lm	1005839	117.00 CHF	700lm	1005893	125.00 CHF
	4000K	20°	750lm	1005851	117.00 CHF	750lm	1005905	125.00 CHF
		40°	730lm	1005854	117.00 CHF	750lm	1005908	125.00 CHF
		55°	740lm	1005857	117.00 CHF	750lm	1005911	125.00 CHF
	2700K	20°	640lm	1005822	117.00 CHF	670lm	1005876	125.00 CHF
		40°	620lm	1005825	117.00 CHF	670lm	1005879	125.00 CHF
		55°	640lm	1005828	117.00 CHF	670lm	1005882	125.00 CHF
	3000K	20°	700lm	1005840	117.00 CHF	690lm	1005894	125.00 CHF
		40°	670lm	1005843	117.00 CHF	690lm	1005897	125.00 CHF
		55°	690lm	1005846	117.00 CHF	690lm	1005900	125.00 CHF
	4000K	20°	720lm	1005858	117.00 CHF	730lm	1005912	125.00 CHF
		40°	700lm	1005861	117.00 CHF	730lm	1005915	125.00 CHF
		55°	710lm	1005864	117.00 CHF	730lm	1005918	125.00 CHF
	2700K	20°	670lm	1005823	117.00 CHF	720lm	1005877	125.00 CHF
		40°	650lm	1005826	117.00 CHF	720lm	1005880	125.00 CHF
		55°	670lm	1005829	117.00 CHF	720lm	1005883	125.00 CHF
	3000K	20°	730lm	1005841	117.00 CHF	730lm	1005895	125.00 CHF
		40°	700lm	1005844	117.00 CHF	730lm	1005898	125.00 CHF
		55°	720lm	1005847	117.00 CHF	730lm	1005901	125.00 CHF
	4000K	20°	750lm	1005859	117.00 CHF	790lm	1005913	125.00 CHF
		40°	730lm	1005862	117.00 CHF	790lm	1005916	125.00 CHF
		55°	740lm	1005865	117.00 CHF	790lm	1005919	125.00 CHF
	2700K	20°	670lm	1005824	117.00 CHF	690lm	1005878	125.00 CHF
		40°	650lm	1005827	117.00 CHF	690lm	1005881	125.00 CHF
		55°	670lm	1005830	117.00 CHF	690lm	1005884	125.00 CHF
	3000K	20°	730lm	1005842	117.00 CHF	700lm	1005896	125.00 CHF
		40°	700lm	1005845	117.00 CHF	700lm	1005899	125.00 CHF
		55°	720lm	1005848	117.00 CHF	700lm	1005902	125.00 CHF
	4000K	20°	750lm	1005860	117.00 CHF	750lm	1005914	125.00 CHF
		40°	730lm	1005863	117.00 CHF	750lm	1005917	125.00 CHF
		55°	740lm	1005866	117.00 CHF	750lm	1005920	125.00 CHF



M 500mA Puissance totale : 17,5W Matière : aluminium / polycarbonate (PC) **L** 700mA Puissance totale : 25,4W Matière : aluminium / polycarbonate (PC) **XL** 1000 / 1050mA Puissance totale : 37,4W Matière : aluminium / polycarbonate (PC)

	2700K	20°	1460lm	1005921	129.00 CHF	2150lm	1005975	139.00 CHF	3300lm	1006029	169.00 CHF
		40°	1460lm	1005924	129.00 CHF	2150lm	1005978	139.00 CHF	3300lm	1006032	169.00 CHF
		55°	1460lm	1005927	129.00 CHF	2150lm	1005981	139.00 CHF	3300lm	1006035	169.00 CHF
	3000K	20°	1500lm	1005939	129.00 CHF	2150lm	1005993	139.00 CHF	3300lm	1006047	169.00 CHF
		40°	1500lm	1005942	129.00 CHF	2150lm	1005996	139.00 CHF	3300lm	1006050	169.00 CHF
		55°	1500lm	1005945	129.00 CHF	2150lm	1005999	139.00 CHF	3300lm	1006053	169.00 CHF
	4000K	20°	1600lm	1005957	129.00 CHF	2350lm	1006011	139.00 CHF	3600lm	1006065	169.00 CHF
		40°	1600lm	1005960	129.00 CHF	2350lm	1006014	139.00 CHF	3600lm	1006068	169.00 CHF
		55°	1600lm	1005963	129.00 CHF	2350lm	1006017	139.00 CHF	3600lm	1006071	169.00 CHF
	2700K	20°	1600lm	1005922	129.00 CHF	2250lm	1005976	139.00 CHF	3500lm	1006030	169.00 CHF
		40°	1600lm	1005925	129.00 CHF	2250lm	1005979	139.00 CHF	3500lm	1006033	169.00 CHF
		55°	1600lm	1005928	129.00 CHF	2250lm	1005982	139.00 CHF	3500lm	1006036	169.00 CHF
	3000K	20°	1600lm	1005940	129.00 CHF	2300lm	1005994	139.00 CHF	3550lm	1006048	169.00 CHF
		40°	1600lm	1005943	129.00 CHF	2300lm	1005997	139.00 CHF	3550lm	1006051	169.00 CHF
		55°	1600lm	1005946	129.00 CHF	2300lm	1006000	139.00 CHF	3550lm	1006054	169.00 CHF
	4000K	20°	1750lm	1005958	129.00 CHF	2450lm	1006012	139.00 CHF	3800lm	1006066	169.00 CHF
		40°	1750lm	1005961	129.00 CHF	2450lm	1006015	139.00 CHF	3800lm	1006069	169.00 CHF
		55°	1750lm	1005964	129.00 CHF	2450lm	1006018	139.00 CHF	3800lm	1006072	169.00 CHF
	2700K	20°	1550lm	1005923	129.00 CHF	2150lm	1005977	139.00 CHF	3400lm	1006031	169.00 CHF
		40°	1550lm	1005926	129.00 CHF	2150lm	1005980	139.00 CHF	3400lm	1006034	169.00 CHF
		55°	1550lm	1005929	129.00 CHF	2150lm	1005983	139.00 CHF	3400lm	1006037	169.00 CHF
	3000K	20°	1550lm	1005941	129.00 CHF	2200lm	1005995	139.00 CHF	3500lm	1006049	169.00 CHF
		40°	1550lm	1005944	129.00 CHF	2200lm	1005998	139.00 CHF	3500lm	1006052	169.00 CHF
		55°	1550lm	1005947	129.00 CHF	2200lm	1006001	139.00 CHF	3500lm	1006055	169.00 CHF
	4000K	20°	1660lm	1005959	129.00 CHF	2350lm	1006013	139.00 CHF	3750lm	1006067	169.00 CHF
		40°	1660lm	1005962	129.00 CHF	2350lm	1006016	139.00 CHF	3750lm	1006070	169.00 CHF
		55°	1660lm	1005965	129.00 CHF	2350lm	1006019	139.00 CHF	3750lm	1006073	169.00 CHF
	2700K	20°	1460lm	1005930	129.00 CHF	2150lm	1005984	139.00 CHF	3300lm	1006038	169.00 CHF
		40°	1460lm	1005933	129.00 CHF	2150lm	1005987	139.00 CHF	3300lm	1006041	169.00 CHF
		55°	1460lm	1005936	129.00 CHF	2150lm	1005990	139.00 CHF	3300lm	1006044	169.00 CHF
	3000K	20°	1500lm	1005948	129.00 CHF	2150lm	1006002	139.00 CHF	3300lm	1006056	169.00 CHF
		40°	1500lm	1005951	129.00 CHF	2150lm	1006005	139.00 CHF	3300lm	1006059	169.00 CHF
		55°	1500lm	1005954	129.00 CHF	2150lm	1006008	139.00 CHF	3300lm	1006062	169.00 CHF
	4000K	20°	1600lm	1005966	129.00 CHF	2350lm	1006020	139.00 CHF	3600lm	1006074	169.00 CHF
		40°	1600lm	1005969	129.00 CHF	2350lm	1006023	139.00 CHF	3600lm	1006077	169.00 CHF
		55°	1600lm	1005972	129.00 CHF	2350lm	1006026	139.00 CHF	3600lm	1006080	169.00 CHF
	2700K	20°	1600lm	1005931	129.00 CHF	2250lm	1005985	139.00 CHF	3500lm	1006039	169.00 CHF
		40°	1600lm	1005934	129.00 CHF	2250lm	1005988	139.00 CHF	3500lm	1006042	169.00 CHF
		55°	1600lm	1005937	129.00 CHF	2250lm	1005991	139.00 CHF	3500lm	1006045	169.00 CHF
	3000K	20°	1600lm	1005949	129.00 CHF	2300lm	1006003	139.00 CHF	3550lm	1006057	169.00 CHF
		40°	1600lm	1005952	129.00 CHF	2300lm	1006006	139.00 CHF	3550lm	1006060	169.00 CHF
		55°	1600lm	1005955	129.00 CHF	2300lm	1006009	139.00 CHF	3550lm	1006063	169.00 CHF
	4000K	20°	1750lm	1005967	129.00 CHF	2450lm	1006021	139.00 CHF	3800lm	1006075	169.00 CHF
		40°	1750lm	1005970	129.00 CHF	2450lm	1006024	139.00 CHF	3800lm	1006078	169.00 CHF
		55°	1750lm	1005973	129.00 CHF	2450lm	1006027	139.00 CHF	3800lm	1006081	169.00 CHF
	2700K	20°	1550lm	1005932	129.00 CHF	2150lm	1005986	139.00 CHF	3400lm	1006040	169.00 CHF
		40°	1550lm	1005935	129.00 CHF	2150lm	1005989	139.00 CHF	3400lm	1006043	169.00 CHF
		55°	1550lm	1005938	129.00 CHF	2150lm	1005992	139.00 CHF	3400lm	1006046	169.00 CHF
	3000K	20°	1550lm	1005950	129.00 CHF	2200lm	1006004	139.00 CHF	3500lm	1006058	169.00 CHF
		40°	1550lm	1005953	129.00 CHF	2200lm	1006007	139.00 CHF	3500lm	1006061	169.00 CHF
		55°	1550lm	1005956	129.00 CHF	2200lm	1006010	139.00 CHF	3500lm	1006064	169.00 CHF
	4000K	20°	1660lm	1005968	129.00 CHF	2350lm	1006022	139.00 CHF	3750lm	1006076	169.00 CHF
		40°	1660lm	1005971	129.00 CHF	2350lm	1006025	139.00 CHF	3750lm	1006079	169.00 CHF
		55°	1660lm	1005974	129.00 CHF	2350lm	1006028	139.00 CHF	3750lm	1006082	169.00 CHF

NUMINOS® PROJECTOR
1006978



NUMINOS® PROJECTOR Downlight (DL)

NEW



L'utilisation du NUMINOS®
PROJECTOR peut être
choisie individuellement



Compléments pour
les séries NUMINOS®
dans les tailles XS-L



NUMINOS® PROJECTOR DL Move











L80B50 330° 90° 10



Fiche basse tension

XS 200mA
Puissance totale : 7W
Matière : aluminium

S 250mA
Puissance totale : 8,6W
Matière : aluminium











	2700K	20°	640lm	1006867	162.00 CHF	670lm	1006921	175.00 CHF
		40°	620lm	1006870	162.00 CHF	670lm	1006924	175.00 CHF
		55°	640lm	1006873	162.00 CHF	670lm	1006927	175.00 CHF
	3000K	20°	700lm	1006885	162.00 CHF	690lm	1006939	175.00 CHF
		40°	670lm	1006888	162.00 CHF	690lm	1006942	175.00 CHF
		55°	690lm	1006891	162.00 CHF	690lm	1006945	175.00 CHF
	2700K	20°	730lm	1006868	162.00 CHF	730lm	1006922	175.00 CHF
		40°	700lm	1006871	162.00 CHF	730lm	1006925	175.00 CHF
		55°	720lm	1006874	162.00 CHF	730lm	1006928	175.00 CHF
	3000K	20°	670lm	1006886	162.00 CHF	690lm	1006940	175.00 CHF
		40°	650lm	1006889	162.00 CHF	690lm	1006943	175.00 CHF
		55°	670lm	1006892	162.00 CHF	690lm	1006946	175.00 CHF
	2700K	20°	670lm	1006869	162.00 CHF	720lm	1006923	175.00 CHF
		40°	650lm	1006872	162.00 CHF	720lm	1006926	175.00 CHF
		55°	670lm	1006875	162.00 CHF	720lm	1006929	175.00 CHF
	3000K	20°	730lm	1006887	162.00 CHF	730lm	1006941	175.00 CHF
		40°	700lm	1006890	162.00 CHF	730lm	1006944	175.00 CHF
		55°	720lm	1006893	162.00 CHF	730lm	1006947	175.00 CHF
	2700K	20°	700lm	1006876	162.00 CHF	690lm	1006930	175.00 CHF
		40°	670lm	1006879	162.00 CHF	690lm	1006933	175.00 CHF
		55°	690lm	1006882	162.00 CHF	690lm	1006936	175.00 CHF
	3000K	20°	670lm	1006894	162.00 CHF	690lm	1006948	175.00 CHF
		40°	650lm	1006897	162.00 CHF	690lm	1006951	175.00 CHF
		55°	670lm	1006900	162.00 CHF	690lm	1006954	175.00 CHF
	2700K	20°	670lm	1006877	162.00 CHF	720lm	1006931	175.00 CHF
		40°	650lm	1006880	162.00 CHF	720lm	1006934	175.00 CHF
		55°	670lm	1006883	162.00 CHF	720lm	1006937	175.00 CHF
	3000K	20°	730lm	1006895	162.00 CHF	730lm	1006949	175.00 CHF
		40°	700lm	1006898	162.00 CHF	730lm	1006952	175.00 CHF
		55°	720lm	1006901	162.00 CHF	730lm	1006955	175.00 CHF
	2700K	20°	670lm	1006878	162.00 CHF	690lm	1006932	175.00 CHF
		40°	650lm	1006881	162.00 CHF	690lm	1006935	175.00 CHF
		55°	670lm	1006884	162.00 CHF	690lm	1006938	175.00 CHF
	3000K	20°	730lm	1006896	162.00 CHF	700lm	1006950	175.00 CHF
		40°	700lm	1006899	162.00 CHF	700lm	1006953	175.00 CHF
		55°	720lm	1006902	162.00 CHF	700lm	1006956	175.00 CHF

Le modèle 4000 K est également disponible sur demande (sauf XS).
Veuillez tenir compte des délais de livraison différents et des quantités minimales de commande.



M 500mA
Puissance totale : 17,5W
Matière : aluminium

L 700mA
Puissance totale : 25,4W
Matière : aluminium

	2700K	20°	1460lm	1006975	187.00 CHF	2150lm	1007029	199.00 CHF
		40°	1460lm	1006978	187.00 CHF	2150lm	1007032	199.00 CHF
		55°	1460lm	1006981	187.00 CHF	2150lm	1007035	199.00 CHF
	3000K	20°	1500lm	1006993	187.00 CHF	2150lm	1007047	199.00 CHF
		40°	1500lm	1006996	187.00 CHF	2150lm	1007050	199.00 CHF
		55°	1500lm	1006999	187.00 CHF	2150lm	1007053	199.00 CHF
	2700K	20°	1600lm	1006976	187.00 CHF	2300lm	1007030	199.00 CHF
		40°	1600lm	1006979	187.00 CHF	2300lm	1007033	199.00 CHF
		55°	1600lm	1006982	187.00 CHF	2300lm	1007036	199.00 CHF
	3000K	20°	1550lm	1006994	187.00 CHF	2150lm	1007048	199.00 CHF
		40°	1550lm	1006997	187.00 CHF	2150lm	1007051	199.00 CHF
		55°	1550lm	1007000	187.00 CHF	2150lm	1007054	199.00 CHF
	2700K	20°	1600lm	1006977	187.00 CHF	2250lm	1007031	199.00 CHF
		40°	1600lm	1006980	187.00 CHF	2250lm	1007034	199.00 CHF
		55°	1600lm	1006983	187.00 CHF	2250lm	1007037	199.00 CHF
	3000K	20°	1600lm	1006995	187.00 CHF	2300lm	1007049	199.00 CHF
		40°	1600lm	1006998	187.00 CHF	2300lm	1007052	199.00 CHF
		55°	1600lm	1007001	187.00 CHF	2300lm	1007055	199.00 CHF
	2700K	20°	1500lm	1006984	187.00 CHF	2150lm	1007038	199.00 CHF
		40°	1500lm	1006987	187.00 CHF	2150lm	1007041	199.00 CHF
		55°	1500lm	1006990	187.00 CHF	2150lm	1007044	199.00 CHF
	3000K	20°	1550lm	1007002	187.00 CHF	2150lm	1007056	199.00 CHF
		40°	1550lm	1007005	187.00 CHF	2150lm	1007059	199.00 CHF
		55°	1550lm	1007008	187.00 CHF	2150lm	1007062	199.00 CHF
	2700K	20°	1600lm	1006985	187.00 CHF	2250lm	1007039	199.00 CHF
		40°	1600lm	1006988	187.00 CHF	2250lm	1007042	199.00 CHF
		55°	1600lm	1006991	187.00 CHF	2250lm	1007045	199.00 CHF
	3000K	20°	1600lm	1007003	187.00 CHF	2300lm	1007057	199.00 CHF
		40°	1600lm	1007006	187.00 CHF	2300lm	1007060	199.00 CHF
		55°	1600lm	1007009	187.00 CHF	2300lm	1007063	199.00 CHF
	2700K	20°	1550lm	1006986	187.00 CHF	2150lm	1007040	199.00 CHF
		40°	1550lm	1006989	187.00 CHF	2150lm	1007043	199.00 CHF
		55°	1550lm	1006992	187.00 CHF	2150lm	1007046	199.00 CHF
	3000K	20°	1550lm	1007004	187.00 CHF	2200lm	1007058	199.00 CHF
		40°	1550lm	1007007	187.00 CHF	2200lm	1007061	199.00 CHF
		55°	1550lm	1007010	187.00 CHF	2200lm	1007064	199.00 CHF

Le modèle 4000 K est également disponible sur demande (sauf XS).
Veuillez tenir compte des délais de livraison différents et des quantités minimales de commande.

DRIVERS COMPATIBLES

XS S M L XL



Driver LED 200mA, 10W QC	blanc	5,8W / 8,4W	-	IP20	L : 6,5 cm, l : 3,9 cm, H : 3,5 cm	1005610	33.00 CHF
Driver LED 200mA, 10W, PHASE QC	blanc	6W / 8,4W	PHASE C		L : 8,5 cm, l : 4,1 cm, H : 3 cm	1005609	44.90 CHF
Driver LED 200mA, 10W, DALI QC	blanc	3,8W / 13,5W	DALI		L : 18 cm, l : 4,5 cm, H : 3 cm	1005611	125.00 CHF
Driver LED 200mA, 12W, DALI + RF Interface QC	blanc	1,5W / 12W	DALI + RF		L : 14,2 cm, l : 4,4 cm, H : 3 cm	1006457	112.00 CHF
Driver LED 250mA, 10W	blanc	6,5W / 10W	-	IP20	L : 6,5 cm, l : 3,9 cm, H : 2 cm	1004058	33.00 CHF
Driver LED 250mA, 10W, PHASE	blanc	7,5W / 10W	PHASE C		L : 8,5 cm, l : 3,9 cm, H : 3 cm	1004055	49.10 CHF
Driver LED 250mA, 20W, DALI	blanc	1,5W / 15W	DALI		L : 15 cm, l : 5,2 cm, H : 2,8 cm	1004067	102.00 CHF
Driver LED 250mA, 12W, DALI + RF Interface QC	blanc	1,5W / 12W	DALI + RF		L : 14,2 cm, l : 4,4 cm, H : 3 cm	1006458	112.00 CHF
Driver LED 500mA, 30W	blanc	15W / 29,5W	-	IP20	L : 14,7 cm, l : 4,3 cm, H : 3 cm	1004064	41.60 CHF
Driver LED 500mA, 30W, PHASE	blanc	12,5W / 21W	PHASE C		L : 11,5 cm, l : 4,1 cm, H : 2,5 cm	1004054	70.00 CHF
Driver LED 500mA, 40W, DALI	blanc	1,5W / 40,6W	DALI		L : 12,3 cm, l : 7,9 cm, H : 2,4 cm	1004069	102.00 CHF
Driver LED 500mA, 42W, DALI + RF Interface QC	blanc	3,5W / 42W	DALI + RF		L : 12,3 cm, l : 7,9 cm, H : 3 cm	1006459	129.00 CHF
Driver LED 700mA, 30W	blanc	15W / 29,5W	-	IP20	L : 14,7 cm, l : 4,3 cm, H : 3 cm	1004062	41.60 CHF
Driver LED 700mA, 30W, PHASE	blanc	21W / 29,4W	PHASE C		L : 11,5 cm, l : 4,4 cm, H : 3 cm	1004065	70.00 CHF
Driver LED 700mA, 40W, DALI	blanc	1,5W / 40,6W	DALI		L : 12,3 cm, l : 7,9 cm, H : 2,4 cm	1004070	102.00 CHF
Driver LED 700mA, 42W, DALI + RF Interface QC	blanc	3,5W / 42W	DALI + RF		L : 12,3 cm, l : 7,9 cm, H : 3 cm	1006460	129.00 CHF
Driver LED 1050mA, 40W	blanc	24W / 44W	-	IP20	L : 9,7 cm, l : 4,3 cm, H : 3 cm	1004059	41.60 CHF
Driver LED 1000mA, 40W, PHASE	blanc	26,3W / 42W	PHASE C		L : 14,5 cm, l : 4 cm, H : 3 cm	1004066	79.00 CHF
Driver LED 1050mA, 50W, DALI	blanc	4,2W / 50W	DALI		L : 12,3 cm, l : 7,9 cm, H : 2,4 cm	1004071	102.00 CHF



Un encastré de plafond obsolète, souvent encore équipé de sources lumineuses conventionnelles, doit être remplacé par une alternative économique en énergie et en coûts. Souvent, lors du démontage, la découpe dans le plafond est plus grande que nécessaire.

SLV propose ici la solution adéquate – Les bagues de réduction recouvrent complètement une découpe trop large tout en permettant une fixation optimale du nouveau luminaire compact. Le tout en harmonie parfaite avec le système d'éclairage NUMINOS®.



DIFFUSEURS ET BAGUES DE RÉDUCTION

XS S M L XL



Diffuseur NUMINOS® XS	Elliptique	IP20	Ø : 3,2 cm, H : 0,2 cm	1005612	5.25 CHF
	Prismatique			1005613	6.30 CHF
	Dépoli			1005614	6.30 CHF
	Nid d'abeille			1005615	10.60 CHF
Diffuseur NUMINOS® S	Elliptique	IP20	Ø : 4 cm, H : 0,2 cm	1004786	5.25 CHF
	Prismatique			1004787	6.30 CHF
	Dépoli			1004788	6.30 CHF
	Nid d'abeille			1004789	10.60 CHF
Diffuseur NUMINOS® M	Elliptique	IP20	Ø : 4,75 cm, H : 0,2 cm	1004790	5.25 CHF
	Prismatique			1004791	6.30 CHF
	Dépoli			1004792	6.30 CHF
	Nid d'abeille			1004793	13.80 CHF
Diffuseur NUMINOS® L	Elliptique	IP20	Ø : 5,65 cm, H : 0,2 cm	1004794	6.30 CHF
	Prismatique			1004795	7.40 CHF
	Dépoli			1004796	7.40 CHF
	Nid d'abeille			1004797	19.15 CHF
Diffuseur NUMINOS® XL	Elliptique	IP20	Ø : 7,1 cm, H : 0,2 cm	1004798	7.40 CHF
	Prismatique			1004799	9.50 CHF
	Dépoli			1004800	9.50 CHF
	Nid d'abeille			1004801	25.55 CHF



Bague de réduction <i>Ronde</i>	noir	Découpe du plafond : 8,5-13 cm	Ø extérieur : 16 cm, Ø intérieur : 7 cm H : 5,3 cm	1006135	20.90 CHF
				1006136	
	noir	Découpe du plafond : 12-15 cm	Ø extérieur : 16 cm, Ø intérieur : 9 cm H : 5,3 cm	1006139	18.00 CHF
				1006140	
	noir	Découpe du plafond : 14-18 cm	Ø extérieur : 24 cm, Ø intérieur : 12 cm H : 5,3 cm	1006143	21.50 CHF
				1006144	
	noir	Découpe du plafond : 17-20 cm	Ø extérieur : 24 cm, Ø intérieur : 15 cm H : 5,3 cm	1006147	20.90 CHF
				1006148	
	noir	Découpe du plafond : 20-22 cm	Ø extérieur : 24 cm, Ø intérieur : 18 cm H : 5,3 cm	1006151	20.20 CHF
				1006152	
Bague de réduction <i>Carrée</i>	noir	Découpe du plafond : 8,5-13 cm	Ø intérieur : 7 cm L : 16 cm, l : 16 cm, H : 5,3 cm	1006137	20.90 CHF
				1006138	
	noir	Découpe du plafond : 12-15 cm	Ø intérieur : 9 cm L : 16 cm, l : 16 cm, H : 5,3 cm	1006141	18.00 CHF
				1006142	
	noir	Découpe du plafond : 14-18 cm	Ø intérieur : 12 cm L : 24 cm, l : 24 cm, H : 5,3 cm	1006145	21.50 CHF
				1006146	
	noir	Découpe du plafond : 17-20 cm	Ø intérieur : 15 cm L : 24 cm, l : 24 cm, H : 5,3 cm	1006149	20.90 CHF
				1006150	
	noir	Découpe du plafond : 20-22 cm	Ø intérieur : 18 cm L : 24 cm, l : 24 cm, H : 5,3 cm	1006153	20.20 CHF
				1006154	

NUMINOS® PROJECTOR

Sélectionnez votre NUMINOS® PROJECTOR :

Vous pouvez choisir parmi six coloris, quatre tailles de boîtier avec différentes puissances, deux températures de couleur et trois faisceaux de 20°, 40° et 55°.

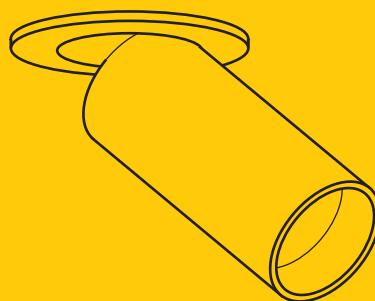
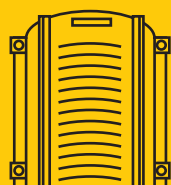
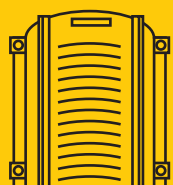

NUMINOS® est un système parfaitement cohérent qui concilie fonctionnalité, design et technologie. Pour les concepteurs de lumière et les installateurs. Pour tous les besoins. Pour un maximum de choix et un minimum d'effort.



Découvrez la diversité
de la série NUMINOS®
sur slv.com

Le nouveau NUMINOS® PROJECTOR
pourvu d'une importante plage
d'inclinaison et d'orientation, com-
plète parfaitement les NUMINOS®
Downlights, qui offrent les mêmes
possibilités décoratives et visuelles.

Disponible en quatre tailles avec
des modules LED de haute
puissance et en deux températures
de couleur.

Les drivers LED sont disponibles
séparément.

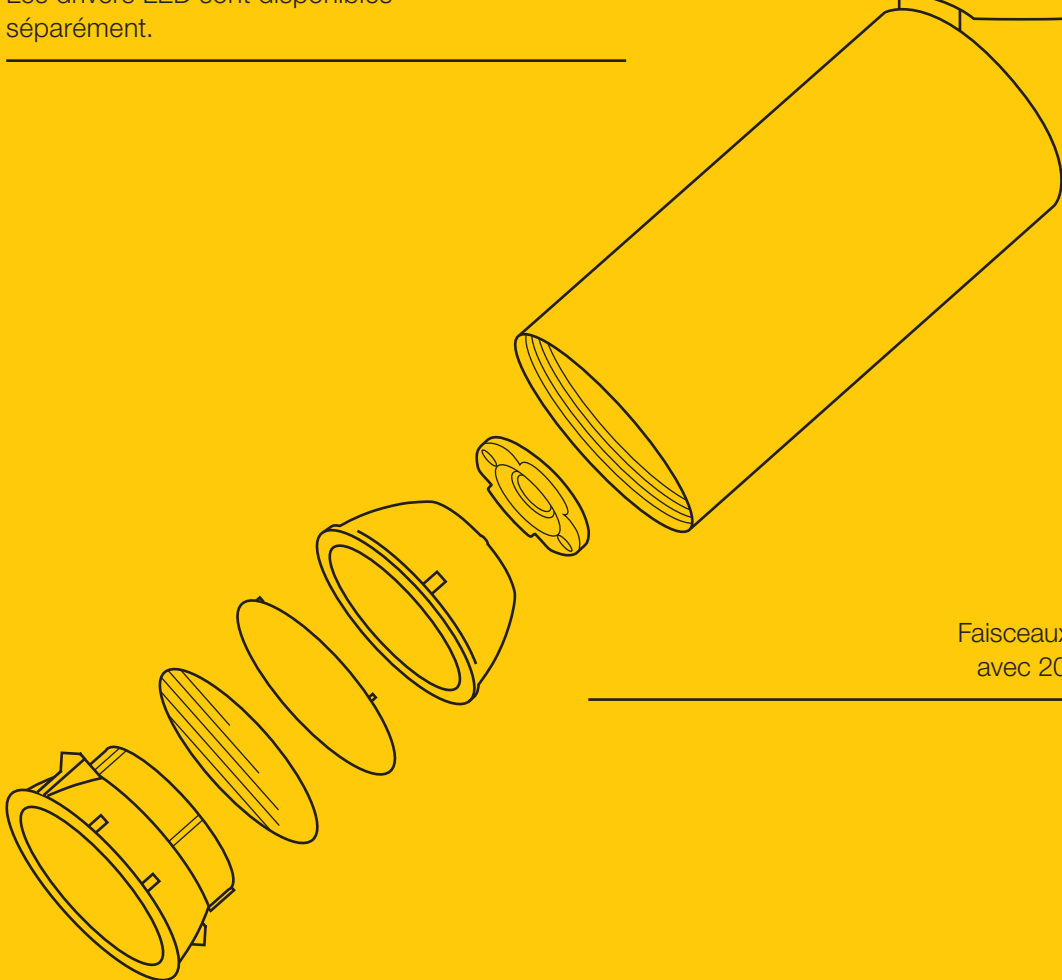
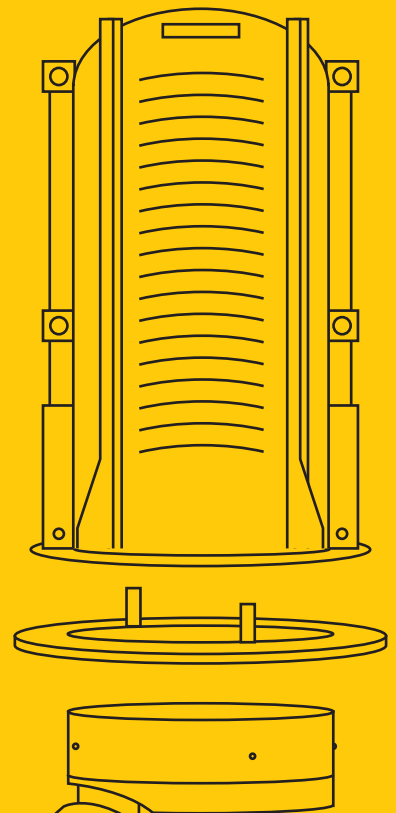

Faisceaux disponibles
avec 20° | 40° | 55°.

NUMINOS® CW
1004587

CLUB LOUNGE 1

TIVOLI



NUMINOS®
Plafonniers et appliques (CW)



NUMINOS® CW
Orientable à 350°
et inclinable à 90°



Anneau décoratif
également
disponible en blanc



Anneau décoratif NUMINOS® S	Ø : 6,2 cm, H : 2 cm	○	1006167	1.50 CHF
Anneau décoratif NUMINOS® M	Ø : 8,2 cm, H : 2,4 cm	○	1006168	3.50 CHF
Anneau décoratif NUMINOS® L	Ø : 9,65 cm, H : 2,5 cm	○	1006169	3.50 CHF
Anneau décoratif NUMINOS® XL	Ø : 11,66 cm, H : 2,85 cm	○	1006170	3.80 CHF



S 220-240V ~50/60Hz | 250mA
Puissance totale : 11W
Matière : aluminium / polycarbonate (PC)

M 220-240V ~50/60Hz | 500mA
Puissance totale : 20W
Matière : aluminium / polycarbonate (PC)

	2700K	24°	985lm	1004098	135.00 CHF	1925lm	1004194	172.00 CHF
		36°	985lm	1004099	135.00 CHF	1935lm	1004195	172.00 CHF
		60°	980lm	1004100	135.00 CHF	1885lm	1004196	172.00 CHF
	3000K	24°	1020lm	1004106	135.00 CHF	1955lm	1004202	172.00 CHF
		36°	1020lm	1004107	135.00 CHF	1970lm	1004203	172.00 CHF
		60°	1020lm	1004108	135.00 CHF	1880lm	1004204	172.00 CHF
	4000K	24°	1100lm	1004114	135.00 CHF	2125lm	1004210	172.00 CHF
		36°	1100lm	1004115	135.00 CHF	2120lm	1004211	172.00 CHF
		60°	1100lm	1004116	135.00 CHF	2060lm	1004212	172.00 CHF
	2700K	24°	985lm	1004386	193.00 CHF	1925lm	1004482	209.00 CHF
		36°	985lm	1004387	193.00 CHF	1935lm	1004483	209.00 CHF
		60°	980lm	1004388	193.00 CHF	1885lm	1004484	209.00 CHF
	3000K	24°	1020lm	1004394	193.00 CHF	1955lm	1004490	209.00 CHF
		36°	1020lm	1004395	193.00 CHF	1970lm	1004491	209.00 CHF
		60°	1020lm	1004396	193.00 CHF	1880lm	1004492	209.00 CHF
	4000K	24°	1100lm	1004402	193.00 CHF	2125lm	1004498	209.00 CHF
		36°	1100lm	1004403	193.00 CHF	2120lm	1004499	209.00 CHF
		60°	1100lm	1004404	193.00 CHF	2060lm	1004500	209.00 CHF
	2700K	24°	985lm	1004102	135.00 CHF	1925lm	1004198	172.00 CHF
		36°	985lm	1004103	135.00 CHF	1935lm	1004199	172.00 CHF
		60°	980lm	1004104	135.00 CHF	1885lm	1004200	172.00 CHF
	3000K	24°	1020lm	1004110	135.00 CHF	1955lm	1004206	172.00 CHF
		36°	1020lm	1004111	135.00 CHF	1970lm	1004207	172.00 CHF
		60°	1020lm	1004112	135.00 CHF	1880lm	1004208	172.00 CHF
	4000K	24°	1100lm	1004118	135.00 CHF	2125lm	1004214	172.00 CHF
		36°	1100lm	1004119	135.00 CHF	2120lm	1004215	172.00 CHF
		60°	1100lm	1004120	135.00 CHF	2060lm	1004216	172.00 CHF
	2700K	24°	985lm	1004390	193.00 CHF	1925lm	1004486	209.00 CHF
		36°	985lm	1004391	193.00 CHF	1935lm	1004487	209.00 CHF
		60°	980lm	1004392	193.00 CHF	1885lm	1004488	209.00 CHF
	3000K	24°	1020lm	1004398	193.00 CHF	1955lm	1004494	209.00 CHF
		36°	1020lm	1004399	193.00 CHF	1970lm	1004495	209.00 CHF
		60°	1020lm	1004400	193.00 CHF	1880lm	1004496	209.00 CHF
	4000K	24°	1100lm	1004406	193.00 CHF	2125lm	1004502	209.00 CHF
		36°	1100lm	1004407	193.00 CHF	2120lm	1004503	209.00 CHF
		60°	1100lm	1004408	193.00 CHF	2060lm	1004504	209.00 CHF



L	220-240V ~50/60Hz 700mA Puissance totale : 28W Matière : aluminium / polycarbonate (PC)	XL	220-240V ~50/60Hz 900mA Puissance totale : 36W Matière : aluminium / polycarbonate (PC)
----------	---	-----------	---

	2700K	24°	2440lm	1004290	185.00 CHF	3290lm	1006083	219.00 CHF
		36°	2400lm	1004291	185.00 CHF	3250lm	1006084	219.00 CHF
		60°	2475lm	1004292	185.00 CHF	2980lm	1006085	219.00 CHF
	3000K	24°	2430lm	1004298	185.00 CHF	3530lm	1006089	219.00 CHF
		36°	2340lm	1004299	185.00 CHF	3490lm	1006090	219.00 CHF
		60°	2400lm	1004300	185.00 CHF	3210lm	1006091	219.00 CHF
	4000K	24°	2675lm	1004306	185.00 CHF	3800lm	1006095	219.00 CHF
		36°	2620lm	1004307	185.00 CHF	3760lm	1006096	219.00 CHF
		60°	2715lm	1004308	185.00 CHF	3460lm	1006097	219.00 CHF
	2700K	24°	2440lm	1004578	259.00 CHF	3290lm	1005741	279.00 CHF
		36°	2400lm	1004579	259.00 CHF	3250lm	1005742	279.00 CHF
		60°	2475lm	1004580	259.00 CHF	2980lm	1005743	279.00 CHF
	3000K	24°	2430lm	1004586	259.00 CHF	3530lm	1005747	279.00 CHF
		36°	2340lm	1004587	259.00 CHF	3490lm	1005748	279.00 CHF
		60°	2400lm	1004588	259.00 CHF	3210lm	1005749	279.00 CHF
	4000K	24°	2675lm	1004594	259.00 CHF	3800lm	1005753	279.00 CHF
		36°	2620lm	1004595	259.00 CHF	3760lm	1005754	279.00 CHF
		60°	2715lm	1004596	259.00 CHF	3460lm	1005755	279.00 CHF
	2700K	24°	2440lm	1004294	185.00 CHF	3290lm	1006086	219.00 CHF
		36°	2400lm	1004295	185.00 CHF	3250lm	1006087	219.00 CHF
		60°	2475lm	1004296	185.00 CHF	2980lm	1006088	219.00 CHF
	3000K	24°	2430lm	1004302	185.00 CHF	3530lm	1006092	219.00 CHF
		36°	2340lm	1004303	185.00 CHF	3490lm	1006093	219.00 CHF
		60°	2400lm	1004304	185.00 CHF	3210lm	1006094	219.00 CHF
	4000K	24°	2675lm	1004310	185.00 CHF	3800lm	1006098	219.00 CHF
		36°	2620lm	1004311	185.00 CHF	3760lm	1006099	219.00 CHF
		60°	2715lm	1004312	185.00 CHF	3460lm	1006100	219.00 CHF
	2700K	24°	2440lm	1004582	259.00 CHF	3290lm	1005744	279.00 CHF
		36°	2400lm	1004583	259.00 CHF	3250lm	1005745	279.00 CHF
		60°	2475lm	1004584	259.00 CHF	2980lm	1005746	279.00 CHF
	3000K	24°	2430lm	1004590	259.00 CHF	3530lm	1005750	279.00 CHF
		36°	2340lm	1004591	259.00 CHF	3490lm	1005751	279.00 CHF
		60°	2400lm	1004592	259.00 CHF	3210lm	1005752	279.00 CHF
	4000K	24°	2675lm	1004598	259.00 CHF	3800lm	1005756	279.00 CHF
		36°	2620lm	1004599	259.00 CHF	3760lm	1005757	279.00 CHF
		60°	2715lm	1004600	259.00 CHF	3460lm	1005758	279.00 CHF

NUMINOS® CL
1004227





NUMINOS®
Plafonniers (CL)















Anneau décoratif également disponible en blanc



Anneau décoratif <i>NUMINOS® S</i>	Ø : 6,2 cm, H : 2 cm	○	1006167	1.50 CHF
Anneau décoratif <i>NUMINOS® M</i>	Ø : 8,2 cm, H : 2,4 cm	○	1006168	3.50 CHF
Anneau décoratif <i>NUMINOS® L</i>	Ø : 9,65 cm, H : 2,5 cm	○	1006169	3.50 CHF
Anneau décoratif <i>NUMINOS® XL</i>	Ø : 11,66 cm, H : 2,85 cm	○	1006170	3.80 CHF

















S 220-240V ~50/60Hz | 250mA
Puissance totale : 11W
Matière : aluminium / polycarbonate (PC)

M 220-240V ~50/60Hz | 500mA
Puissance totale : 20W
Matière : aluminium / polycarbonate (PC)

	2700K	24°	985lm	1004122	115.00 CHF	1925lm	1004218	145.00 CHF
		36°	985lm	1004123	115.00 CHF	1935lm	1004219	145.00 CHF
		60°	980lm	1004124	115.00 CHF	1885lm	1004220	145.00 CHF
	3000K	24°	1020lm	1004130	115.00 CHF	1955lm	1004226	145.00 CHF
		36°	1020lm	1004131	115.00 CHF	1970lm	1004227	145.00 CHF
		60°	1020lm	1004132	115.00 CHF	1880lm	1004228	145.00 CHF
	4000K	24°	1100lm	1004138	115.00 CHF	2125lm	1004234	145.00 CHF
		36°	1100lm	1004139	115.00 CHF	2120lm	1004235	145.00 CHF
		60°	1100lm	1004140	115.00 CHF	2060lm	1004236	145.00 CHF
	2700K	24°	985lm	1004410	175.00 CHF	1925lm	1004506	185.00 CHF
		36°	985lm	1004411	175.00 CHF	1935lm	1004507	185.00 CHF
		60°	980lm	1004412	175.00 CHF	1885lm	1004508	185.00 CHF
	3000K	24°	1020lm	1004418	175.00 CHF	1955lm	1004514	185.00 CHF
		36°	1020lm	1004419	175.00 CHF	1970lm	1004515	185.00 CHF
		60°	1020lm	1004420	175.00 CHF	1880lm	1004516	185.00 CHF
	4000K	24°	1100lm	1004426	175.00 CHF	2125lm	1004522	185.00 CHF
		36°	1100lm	1004427	175.00 CHF	2120lm	1004523	185.00 CHF
		60°	1100lm	1004428	175.00 CHF	2060lm	1004524	185.00 CHF
	2700K	24°	985lm	1004126	115.00 CHF	1925lm	1004222	145.00 CHF
		36°	985lm	1004127	115.00 CHF	1935lm	1004223	145.00 CHF
		60°	980lm	1004128	115.00 CHF	1885lm	1004224	145.00 CHF
	3000K	24°	1020lm	1004134	115.00 CHF	1955lm	1004230	145.00 CHF
		36°	1020lm	1004135	115.00 CHF	1970lm	1004231	145.00 CHF
		60°	1020lm	1004136	115.00 CHF	1880lm	1004232	145.00 CHF
	4000K	24°	1100lm	1004142	115.00 CHF	2125lm	1004238	145.00 CHF
		36°	1100lm	1004143	115.00 CHF	2120lm	1004239	145.00 CHF
		60°	1100lm	1004144	115.00 CHF	2060lm	1004240	145.00 CHF
	2700K	24°	985lm	1004414	175.00 CHF	1925lm	1004510	185.00 CHF
		36°	985lm	1004415	175.00 CHF	1935lm	1004511	185.00 CHF
		60°	980lm	1004416	175.00 CHF	1885lm	1004512	185.00 CHF
	3000K	24°	1020lm	1004422	175.00 CHF	1955lm	1004518	185.00 CHF
		36°	1020lm	1004423	175.00 CHF	1970lm	1004519	185.00 CHF
		60°	1020lm	1004424	175.00 CHF	1880lm	1004520	185.00 CHF
	4000K	24°	1100lm	1004430	175.00 CHF	2125lm	1004526	185.00 CHF
		36°	1100lm	1004431	175.00 CHF	2120lm	1004527	185.00 CHF
		60°	1100lm	1004432	175.00 CHF	2060lm	1004528	185.00 CHF



L 220-240V ~50/60Hz | 700mA Puissance totale : 28W Matière : aluminium / polycarbonate (PC) **XL** 220-240V ~50/60Hz | 900mA Puissance totale : 36W Matière : aluminium / polycarbonate (PC)

		2700K	24°	2440lm	1004314	172.00 CHF	3290lm	1005687	219.00 CHF
			36°	2400lm	1004315	172.00 CHF	3250lm	1005688	219.00 CHF
			60°	2475lm	1004316	172.00 CHF	2980lm	1005689	219.00 CHF
		3000K	24°	2430lm	1004322	172.00 CHF	3530lm	1005693	219.00 CHF
			36°	2340lm	1004323	172.00 CHF	3490lm	1005694	219.00 CHF
			60°	2400lm	1004324	172.00 CHF	3210lm	1005695	219.00 CHF
		4000K	24°	2675lm	1004330	172.00 CHF	3800lm	1005699	219.00 CHF
			36°	2620lm	1004331	172.00 CHF	3760lm	1005700	219.00 CHF
			60°	2715lm	1004332	172.00 CHF	3460lm	1005701	219.00 CHF
		2700K	24°	2440lm	1004602	219.00 CHF	3290lm	1005759	279.00 CHF
			36°	2400lm	1004603	219.00 CHF	3250lm	1005760	279.00 CHF
			60°	2475lm	1004604	219.00 CHF	2980lm	1005761	279.00 CHF
		3000K	24°	2430lm	1004610	219.00 CHF	3530lm	1005765	279.00 CHF
			36°	2340lm	1004611	219.00 CHF	3490lm	1005766	279.00 CHF
			60°	2400lm	1004612	219.00 CHF	3210lm	1005767	279.00 CHF
		4000K	24°	2675lm	1004618	219.00 CHF	3800lm	1005771	279.00 CHF
			36°	2620lm	1004619	219.00 CHF	3760lm	1005772	279.00 CHF
			60°	2715lm	1004620	219.00 CHF	3460lm	1005773	279.00 CHF
		2700K	24°	2440lm	1004318	172.00 CHF	3290lm	1005690	219.00 CHF
			36°	2400lm	1004319	172.00 CHF	3250lm	1005691	219.00 CHF
			60°	2475lm	1004320	172.00 CHF	2980lm	1005692	219.00 CHF
		3000K	24°	2430lm	1004326	172.00 CHF	3530lm	1005696	219.00 CHF
			36°	2340lm	1004327	172.00 CHF	3490lm	1005697	219.00 CHF
			60°	2400lm	1004328	172.00 CHF	3210lm	1005698	219.00 CHF
		4000K	24°	2675lm	1004334	172.00 CHF	3800lm	1005702	219.00 CHF
			36°	2620lm	1004335	172.00 CHF	3760lm	1005703	219.00 CHF
			60°	2715lm	1004336	172.00 CHF	3460lm	1005704	219.00 CHF
		2700K	24°	2440lm	1004606	219.00 CHF	3290lm	1005762	279.00 CHF
			36°	2400lm	1004607	219.00 CHF	3250lm	1005763	279.00 CHF
			60°	2475lm	1004608	219.00 CHF	2980lm	1005764	279.00 CHF
		3000K	24°	2430lm	1004614	219.00 CHF	3530lm	1005768	279.00 CHF
			36°	2340lm	1004615	219.00 CHF	3490lm	1005769	279.00 CHF
			60°	2400lm	1004616	219.00 CHF	3210lm	1005770	279.00 CHF
		4000K	24°	2675lm	1004622	219.00 CHF	3800lm	1005774	279.00 CHF
			36°	2620lm	1004623	219.00 CHF	3760lm	1005775	279.00 CHF
			60°	2715lm	1004624	219.00 CHF	3460lm	1005776	279.00 CHF

NUMINOS® PD
1005787





NUMINOS®
Suspensions (PD)



Anneau décoratif également disponible en blanc



Anneau décoratif NUMINOS® S	Ø : 6,2 cm, H : 2 cm	<input type="radio"/>	1006167	1.50 CHF
Anneau décoratif NUMINOS® M	Ø : 8,2 cm, H : 2,4 cm	<input type="radio"/>	1006168	3.50 CHF
Anneau décoratif NUMINOS® L	Ø : 9,65 cm, H : 2,5 cm	<input type="radio"/>	1006169	3.50 CHF
Anneau décoratif NUMINOS® XL	Ø : 11,66 cm, H : 2,85 cm	<input type="radio"/>	1006170	3.80 CHF

Retrouvez toutes les dimensions et informations de montage détaillées en pages 118–119









<p>S 220-240V ~50/60Hz 250mA Puissance totale : 11W Matière : aluminium / polycarbonate (PC)</p>	<p>M 220-240V ~50/60Hz 500mA Puissance totale : 20W Matière : aluminium / polycarbonate (PC)</p>
---	---

	2700K	24°	985lm	1004146	165.00 CHF	1925lm	1004242	187.00 CHF
		36°	985lm	1004147	165.00 CHF	1935lm	1004243	187.00 CHF
		60°	980lm	1004148	165.00 CHF	1885lm	1004244	187.00 CHF
	3000K	24°	1020lm	1004154	165.00 CHF	1955lm	1004250	187.00 CHF
		36°	1020lm	1004155	165.00 CHF	1970lm	1004251	187.00 CHF
		60°	1020lm	1004156	165.00 CHF	1880lm	1004252	187.00 CHF
	4000K	24°	1100lm	1004162	165.00 CHF	2125lm	1004258	187.00 CHF
		36°	1100lm	1004163	165.00 CHF	2120lm	1004259	187.00 CHF
		60°	1100lm	1004164	165.00 CHF	2060lm	1004260	187.00 CHF
	2700K	24°	985lm	1004434	219.00 CHF	1925lm	1004530	235.00 CHF
		36°	985lm	1004435	219.00 CHF	1935lm	1004531	235.00 CHF
		60°	980lm	1004436	219.00 CHF	1885lm	1004532	235.00 CHF
	3000K	24°	1020lm	1004442	219.00 CHF	1955lm	1004538	235.00 CHF
		36°	1020lm	1004443	219.00 CHF	1970lm	1004539	235.00 CHF
		60°	1020lm	1004444	219.00 CHF	1880lm	1004540	235.00 CHF
	4000K	24°	1100lm	1004450	219.00 CHF	2125lm	1004546	235.00 CHF
		36°	1100lm	1004451	219.00 CHF	2120lm	1004547	235.00 CHF
		60°	1100lm	1004452	219.00 CHF	2060lm	1004548	235.00 CHF
	2700K	24°	985lm	1004150	165.00 CHF	1925lm	1004246	187.00 CHF
		36°	985lm	1004151	165.00 CHF	1935lm	1004247	187.00 CHF
		60°	980lm	1004152	165.00 CHF	1885lm	1004248	187.00 CHF
	3000K	24°	1020lm	1004158	165.00 CHF	1955lm	1004254	187.00 CHF
		36°	1020lm	1004159	165.00 CHF	1970lm	1004255	187.00 CHF
		60°	1020lm	1004160	165.00 CHF	1880lm	1004256	187.00 CHF
	4000K	24°	1100lm	1004166	165.00 CHF	2125lm	1004262	187.00 CHF
		36°	1100lm	1004167	165.00 CHF	2120lm	1004263	187.00 CHF
		60°	1100lm	1004168	165.00 CHF	2060lm	1004264	187.00 CHF
	2700K	24°	985lm	1004438	219.00 CHF	1925lm	1004534	235.00 CHF
		36°	985lm	1004439	219.00 CHF	1935lm	1004535	235.00 CHF
		60°	980lm	1004440	219.00 CHF	1885lm	1004536	235.00 CHF
	3000K	24°	1020lm	1004446	219.00 CHF	1955lm	1004542	235.00 CHF
		36°	1020lm	1004447	219.00 CHF	1970lm	1004543	235.00 CHF
		60°	1020lm	1004448	219.00 CHF	1880lm	1004544	235.00 CHF
	4000K	24°	1100lm	1004454	219.00 CHF	2125lm	1004550	235.00 CHF
		36°	1100lm	1004455	219.00 CHF	2120lm	1004551	235.00 CHF
		60°	1100lm	1004456	219.00 CHF	2060lm	1004552	235.00 CHF



L 220-240V ~50/60Hz | 700mA
 Puissance totale : 28W
 Matière : aluminium / polycarbonate

XL 220-240V ~50/60Hz | 900mA
 Puissance totale : 36W
 Matière : aluminium / polycarbonate (PC)

		2700K	24°	2440lm	1004338	209.00 CHF	3290lm	1005705	235.00 CHF
			36°	2400lm	1004339	209.00 CHF	3250lm	1005706	235.00 CHF
			60°	2475lm	1004340	209.00 CHF	2980lm	1005707	235.00 CHF
		3000K	24°	2430lm	1004346	209.00 CHF	3530lm	1005711	235.00 CHF
			36°	2340lm	1004347	209.00 CHF	3490lm	1005712	235.00 CHF
			60°	2400lm	1004348	209.00 CHF	3210lm	1005713	235.00 CHF
		4000K	24°	2675lm	1004354	209.00 CHF	3800lm	1005717	235.00 CHF
			36°	2620lm	1004355	209.00 CHF	3760lm	1005718	235.00 CHF
			60°	2715lm	1004356	209.00 CHF	3460lm	1005719	235.00 CHF
		2700K	24°	2440lm	1004626	269.00 CHF	3290lm	1005777	289.00 CHF
			36°	2400lm	1004627	269.00 CHF	3250lm	1005778	289.00 CHF
			60°	2475lm	1004628	269.00 CHF	2980lm	1005779	289.00 CHF
		3000K	24°	2430lm	1004634	269.00 CHF	3530lm	1005783	289.00 CHF
			36°	2340lm	1004635	269.00 CHF	3490lm	1005784	289.00 CHF
			60°	2400lm	1004636	269.00 CHF	3210lm	1005785	289.00 CHF
		4000K	24°	2675lm	1004642	269.00 CHF	3800lm	1005789	289.00 CHF
			36°	2620lm	1004643	269.00 CHF	3760lm	1005790	289.00 CHF
			60°	2715lm	1004644	269.00 CHF	3460lm	1005791	289.00 CHF
		2700K	24°	2440lm	1004342	209.00 CHF	3290lm	1005708	235.00 CHF
			36°	2400lm	1004343	209.00 CHF	3250lm	1005709	235.00 CHF
			60°	2475lm	1004344	209.00 CHF	2980lm	1005710	235.00 CHF
		3000K	24°	2430lm	1004350	209.00 CHF	3530lm	1005714	235.00 CHF
			36°	2340lm	1004351	209.00 CHF	3490lm	1005715	235.00 CHF
			60°	2400lm	1004352	209.00 CHF	3210lm	1005716	235.00 CHF
		4000K	24°	2675lm	1004358	209.00 CHF	3800lm	1005720	235.00 CHF
			36°	2620lm	1004359	209.00 CHF	3760lm	1005721	235.00 CHF
			60°	2715lm	1004360	209.00 CHF	3460lm	1005722	235.00 CHF
		2700K	24°	2440lm	1004630	269.00 CHF	3290lm	1005780	289.00 CHF
			36°	2400lm	1004631	269.00 CHF	3250lm	1005781	289.00 CHF
			60°	2475lm	1004632	269.00 CHF	2980lm	1005782	289.00 CHF
		3000K	24°	2430lm	1004638	269.00 CHF	3530lm	1005786	289.00 CHF
			36°	2340lm	1004639	269.00 CHF	3490lm	1005787	289.00 CHF
			60°	2400lm	1004640	269.00 CHF	3210lm	1005788	289.00 CHF
		4000K	24°	2675lm	1004646	269.00 CHF	3800lm	1005792	289.00 CHF
			36°	2620lm	1004647	269.00 CHF	3760lm	1005793	289.00 CHF
			60°	2715lm	1004648	269.00 CHF	3460lm	1005794	289.00 CHF

NUMINOS® 3-PH. TRACK
1004083



NUMINOS®
Système Track 3 allumages



Découvrez également les
luminaires NUMINOS®
pour le système 48V
p. 468–471

NUMINOS® 3-PH. TRACK
1004082



Anneau décoratif
également
disponible en blanc



Anneau décoratif NUMINOS® S	Ø : 6,2 cm, H : 2 cm	○	1006167	1.50 CHF
Anneau décoratif NUMINOS® M	Ø : 8,2 cm, H : 2,4 cm	○	1006168	3.50 CHF
Anneau décoratif NUMINOS® L	Ø : 9,65 cm, H : 2,5 cm	○	1006169	3.50 CHF
Anneau décoratif NUMINOS® XL	Ø : 11,66 cm, H : 2,85 cm	○	1006170	3.80 CHF

Retrouvez toutes les dimensions et informations de montage détaillées en pages 118–119



















S 220-240V ~50/60Hz | 250mA
Puissance totale : 11W
Matière : aluminium / polycarbonate (PC)

M 220-240V ~50/60Hz | 500mA
Puissance totale : 20W
Matière : aluminium / polycarbonate (PC)

	2700K	24°	985lm	1004074	135.00 CHF	1925lm	1004170	172.00 CHF
		36°	985lm	1004075	135.00 CHF	1935lm	1004171	172.00 CHF
		60°	980lm	1004076	135.00 CHF	1885lm	1004172	172.00 CHF
	3000K	24°	1020lm	1004082	135.00 CHF	1955lm	1004178	172.00 CHF
		36°	1020lm	1004083	135.00 CHF	1970lm	1004179	172.00 CHF
		60°	1020lm	1004084	135.00 CHF	1880lm	1004180	172.00 CHF
	4000K	24°	1100lm	1004090	135.00 CHF	2125lm	1004186	172.00 CHF
		36°	1100lm	1004091	135.00 CHF	2120lm	1004187	172.00 CHF
		60°	1100lm	1004092	135.00 CHF	2060lm	1004188	172.00 CHF
	2700K	24°	985lm	1004362	193.00 CHF	1925lm	1004458	209.00 CHF
		36°	985lm	1004363	193.00 CHF	1935lm	1004459	209.00 CHF
		60°	980lm	1004364	193.00 CHF	1885lm	1004460	209.00 CHF
	3000K	24°	1020lm	1004370	193.00 CHF	1955lm	1004466	209.00 CHF
		36°	1020lm	1004371	193.00 CHF	1970lm	1004467	209.00 CHF
		60°	1020lm	1004372	193.00 CHF	1880lm	1004468	209.00 CHF
	4000K	24°	1100lm	1004378	193.00 CHF	2125lm	1004474	209.00 CHF
		36°	1100lm	1004379	193.00 CHF	2120lm	1004475	209.00 CHF
		60°	1100lm	1004380	193.00 CHF	2060lm	1004476	209.00 CHF
	2700K	24°	985lm	1004078	135.00 CHF	1925lm	1004174	172.00 CHF
		36°	985lm	1004079	135.00 CHF	1935lm	1004175	172.00 CHF
		60°	980lm	1004080	135.00 CHF	1885lm	1004176	172.00 CHF
	3000K	24°	1020lm	1004086	135.00 CHF	1955lm	1004182	172.00 CHF
		36°	1020lm	1004087	135.00 CHF	1970lm	1004183	172.00 CHF
		60°	1020lm	1004088	135.00 CHF	1880lm	1004184	172.00 CHF
	4000K	24°	1100lm	1004094	135.00 CHF	2125lm	1004190	172.00 CHF
		36°	1100lm	1004095	135.00 CHF	2120lm	1004191	172.00 CHF
		60°	1100lm	1004096	135.00 CHF	2060lm	1004192	172.00 CHF
	2700K	24°	985lm	1004366	193.00 CHF	1925lm	1004462	209.00 CHF
		36°	985lm	1004367	193.00 CHF	1935lm	1004463	209.00 CHF
		60°	980lm	1004368	193.00 CHF	1885lm	1004464	209.00 CHF
	3000K	24°	1020lm	1004374	193.00 CHF	1955lm	1004470	209.00 CHF
		36°	1020lm	1004375	193.00 CHF	1970lm	1004471	209.00 CHF
		60°	1020lm	1004376	193.00 CHF	1880lm	1004472	209.00 CHF
	4000K	24°	1100lm	1004382	193.00 CHF	2125lm	1004478	209.00 CHF
		36°	1100lm	1004383	193.00 CHF	2120lm	1004479	209.00 CHF
		60°	1100lm	1004384	193.00 CHF	2060lm	1004480	209.00 CHF



L	220-240V ~50/60Hz 700mA Puissance totale : 28W Matière : aluminium / polycarbonate (PC)	XL	220-240V ~50/60Hz 900mA Puissance totale : 36W Matière : aluminium / polycarbonate (PC)
----------	---	-----------	---

		2700K	24°	2440lm	1004266	185.00 CHF	3290lm	1005723	209.00 CHF
			36°	2400lm	1004267	185.00 CHF	3250lm	1005724	209.00 CHF
			60°	2475lm	1004268	185.00 CHF	2980lm	1005725	209.00 CHF
		3000K	24°	2430lm	1004274	185.00 CHF	3530lm	1005729	209.00 CHF
			36°	2340lm	1004275	185.00 CHF	3490lm	1005730	209.00 CHF
			60°	2400lm	1004276	185.00 CHF	3210lm	1005731	209.00 CHF
		4000K	24°	2675lm	1004282	185.00 CHF	3800lm	1005735	209.00 CHF
			36°	2620lm	1004283	185.00 CHF	3760lm	1005736	209.00 CHF
			60°	2715lm	1004284	185.00 CHF	3460lm	1005737	209.00 CHF
		2700K	24°	2440lm	1004554	259.00 CHF	3290lm	1005795	289.00 CHF
			36°	2400lm	1004555	259.00 CHF	3250lm	1005796	289.00 CHF
			60°	2475lm	1004556	259.00 CHF	2980lm	1005797	289.00 CHF
		3000K	24°	2430lm	1004562	259.00 CHF	3530lm	1005801	289.00 CHF
			36°	2340lm	1004563	259.00 CHF	3490lm	1005802	289.00 CHF
			60°	2400lm	1004564	259.00 CHF	3210lm	1005803	289.00 CHF
		4000K	24°	2675lm	1004570	259.00 CHF	3800lm	1005807	289.00 CHF
			36°	2620lm	1004571	259.00 CHF	3760lm	1005808	289.00 CHF
			60°	2715lm	1004572	259.00 CHF	3460lm	1005809	289.00 CHF
		2700K	24°	2440lm	1004270	185.00 CHF	3290lm	1005726	209.00 CHF
			36°	2400lm	1004271	185.00 CHF	3250lm	1005727	209.00 CHF
			60°	2475lm	1004272	185.00 CHF	2980lm	1005728	209.00 CHF
		3000K	24°	2430lm	1004278	185.00 CHF	3530lm	1005732	209.00 CHF
			36°	2340lm	1004279	185.00 CHF	3490lm	1005733	209.00 CHF
			60°	2400lm	1004280	185.00 CHF	3210lm	1005734	209.00 CHF
		4000K	24°	2675lm	1004286	185.00 CHF	3800lm	1005738	209.00 CHF
			36°	2620lm	1004287	185.00 CHF	3760lm	1005739	209.00 CHF
			60°	2715lm	1004288	185.00 CHF	3460lm	1005740	209.00 CHF
		2700K	24°	2440lm	1004558	259.00 CHF	3290lm	1005798	289.00 CHF
			36°	2400lm	1004559	259.00 CHF	3250lm	1005799	289.00 CHF
			60°	2475lm	1004560	259.00 CHF	2980lm	1005800	289.00 CHF
		3000K	24°	2430lm	1004566	259.00 CHF	3530lm	1005804	289.00 CHF
			36°	2340lm	1004567	259.00 CHF	3490lm	1005805	289.00 CHF
			60°	2400lm	1004568	259.00 CHF	3210lm	1005806	289.00 CHF
		4000K	24°	2675lm	1004574	259.00 CHF	3800lm	1005810	289.00 CHF
			36°	2620lm	1004575	259.00 CHF	3760lm	1005811	289.00 CHF
			60°	2715lm	1004576	259.00 CHF	3460lm	1005812	289.00 CHF

NUMINOS® ZOOM
1006117



short. Smile while you still have tact



NUMINOS® ZOOM

Système Track 3 allumages



M 220-240V ~50/60Hz | 500mA
 Puissance totale : 20W
 Matière : aluminium / polycarbonate (PC)



	2700K	15°-60°	680-1650lm	1006108	205.00 CHF
	3000K	15°-60°	750-1800lm	1006110	205.00 CHF
	4000K	15°-60°	780-1900lm	1006112	205.00 CHF
	2700K	15°-60°	680-1650lm	1006114	259.00 CHF
	3000K	15°-60°	750-1800lm	1006116	259.00 CHF
	4000K	15°-60°	780-1900lm	1006118	259.00 CHF
	2700K	15°-60°	680-1650lm	1006109	205.00 CHF
	3000K	15°-60°	750-1800lm	1006111	205.00 CHF
	4000K	15°-60°	780-1900lm	1006113	205.00 CHF
	2700K	15°-60°	680-1650lm	1006115	259.00 CHF
	3000K	15°-60°	750-1800lm	1006117	259.00 CHF
	4000K	15°-60°	780-1900lm	1006119	259.00 CHF



Angle de rayonnement réglable de 15° à 60°

Retrouvez toutes les dimensions et informations de montage détaillées en pages 118-119

CONFIGUREZ VOS NUMINOS®

SÉLECTIONNEZ VOTRE/VOS

SYSTÈME

COULEUR

NUMINOS® DL

NUMINOS® MOVE

NUMINOS® GIMBLE

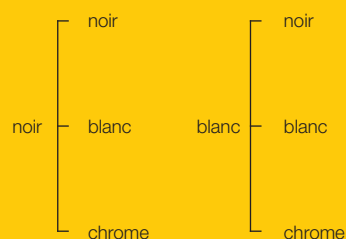

NUMINOS® PROJECTOR

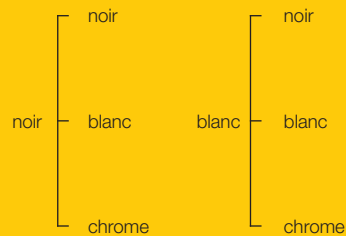

NUMINOS® PD

NUMINOS® CL

NUMINOS® SPOT



NUMINOS® TRACK

NUMINOS® ZOOM



Le système NUMINOS® offre des propriétés d'éclairage constantes et un design moderne pour toutes les utilisations : de l'hôtel au bureau en passant par les espaces commerciaux ou privés. Du mode d'utilisation à la technologie jusqu'aux détails du design : quelle simplicité de pouvoir configurer tous ces luminaires pour répondre aux exigences et aux caractéristiques du projet. Et, plus celui-ci sera complexe, mieux vous pourrez tirer parti des avantages du système d'éclairage NUMINOS®.



TAILLE

PUISSANCE

DIFFUSEURS

XS **S** **M** **L** **XL**

XS	200mA Puissance totale : 7W
S	250mA Puissance totale : 8,6W
M	500mA Puissance totale : 17,5W
L	700mA Puissance totale : 25,4W
XL	1050mA Puissance totale : 37,4W

ELLIPTIQUE

Répartition de lumière longitudinale, légère réduction d'éblouissement, idéal dans les couloirs

PRISMATIQUE

Faisceau plus large, éblouissement plus faible, parfait pour installer des luminaires à intervalle défini

XS **S** **M** **L**

XS	200mA Puissance totale : 7W
S	250mA Puissance totale : 8,6W
M	500mA Puissance totale : 17,5W
L	700mA Puissance totale : 25,4W

DÉPOLI

Faisceau plus large, éclairage accru, parfait pour les petites hauteurs sous plafond

NID D'ABEILLE

Faisceau étroit, éblouissement réduit, idéal pour un poste de travail informatique

Retrouvez les drivers compatibles aux pages 94-95

S **M** **L** **XL**

S	250mA Puissance totale : 11W
M	500mA Puissance totale : 20W
L	700mA Puissance totale : 28W
XL	900mA Puissance totale : 36W

S **M** **L** **XL**

NUMINOS® Zoom est uniquement disponible en 3 tailles

NUMINOS® TAILLES

DOWNLIGHTS

XS

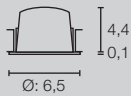

Dimensions d'encastrement :
 \varnothing : 5,5 cm P : 11,0 cm

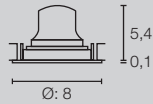

Dimensions d'encastrement :
 \varnothing : 6,8 cm P : 8 cm

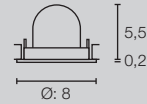

Dimensions d'encastrement :
 \varnothing : 6,8 cm P : 8 cm

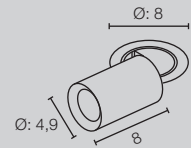

Dimensions d'encastrement :
 \varnothing : 6,8 cm P : 10 cm

S

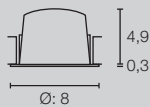

Dimensions d'encastrement :
 \varnothing : 6,8 cm P : 5,5 cm

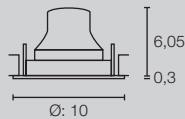

Dimensions d'encastrement :
 \varnothing : 9 cm P : 8,5 cm

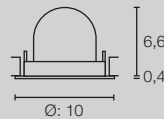

Dimensions d'encastrement :
 \varnothing : 9 cm P : 7 cm

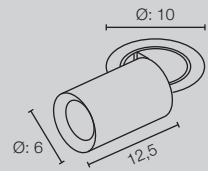

Dimensions d'encastrement :
 \varnothing : 8,8 cm P : 15 cm

M

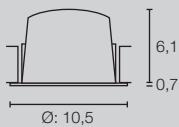

Dimensions d'encastrement :
 \varnothing : 9 cm P : 7,5 cm

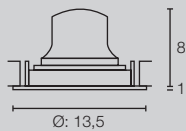

Dimensions d'encastrement :
 \varnothing : 12 cm P : 10 cm

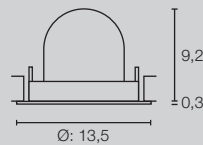

Dimensions d'encastrement :
 \varnothing : 12 cm P : 10 cm

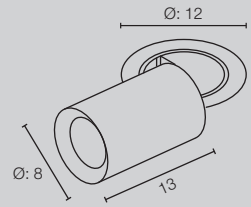

Dimensions d'encastrement :
 \varnothing : 10,5 cm P : 15 cm

L

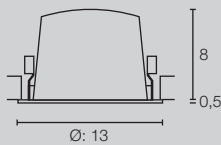

Dimensions d'encastrement :
 \varnothing : 11,7 cm P : 9 cm

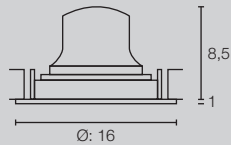

Dimensions d'encastrement :
 \varnothing : 14,5 cm P : 10,5 cm

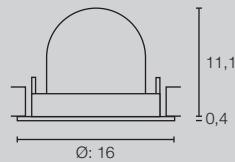

Dimensions d'encastrement :
 \varnothing : 14,5 cm P : 11,5 cm

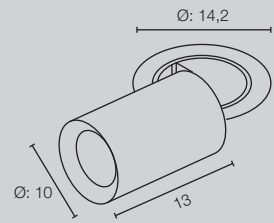

Dimensions d'encastrement :
 \varnothing : 13 cm P : 15 cm

XL

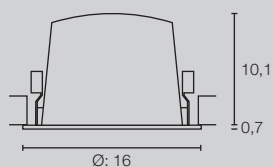

Dimensions d'encastrement :
 \varnothing : 14,5 cm P : 11,5 cm

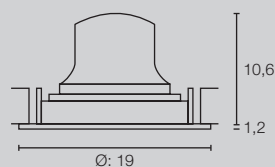

Dimensions d'encastrement :
 \varnothing : 17,5 cm P : 13 cm

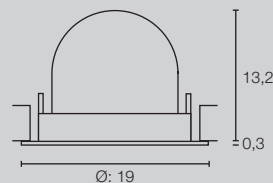

Dimensions d'encastrement :
 \varnothing : 17,5 cm P : 13,5 cm

**NUMINOS®
DL**

**NUMINOS®
MOVE**

**NUMINOS®
GIMBLE**

**NUMINOS®
PROJECTOR**

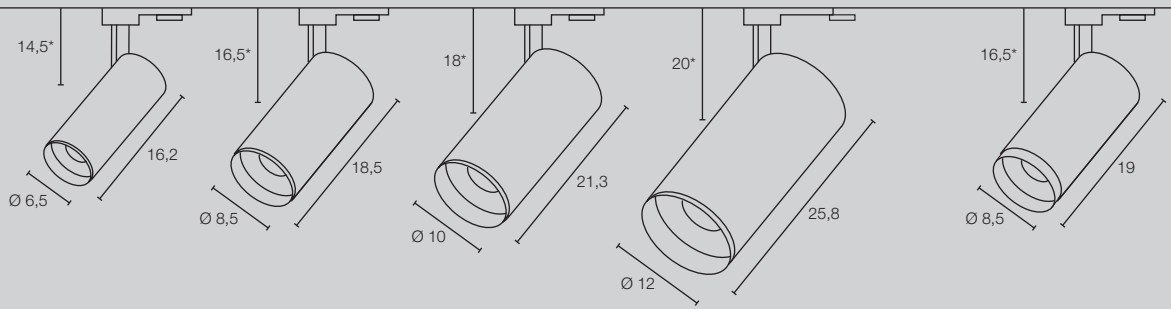
S**M****L****XL****M****NUMINOS® TRACK**

*Pour un angle inférieur à 90°

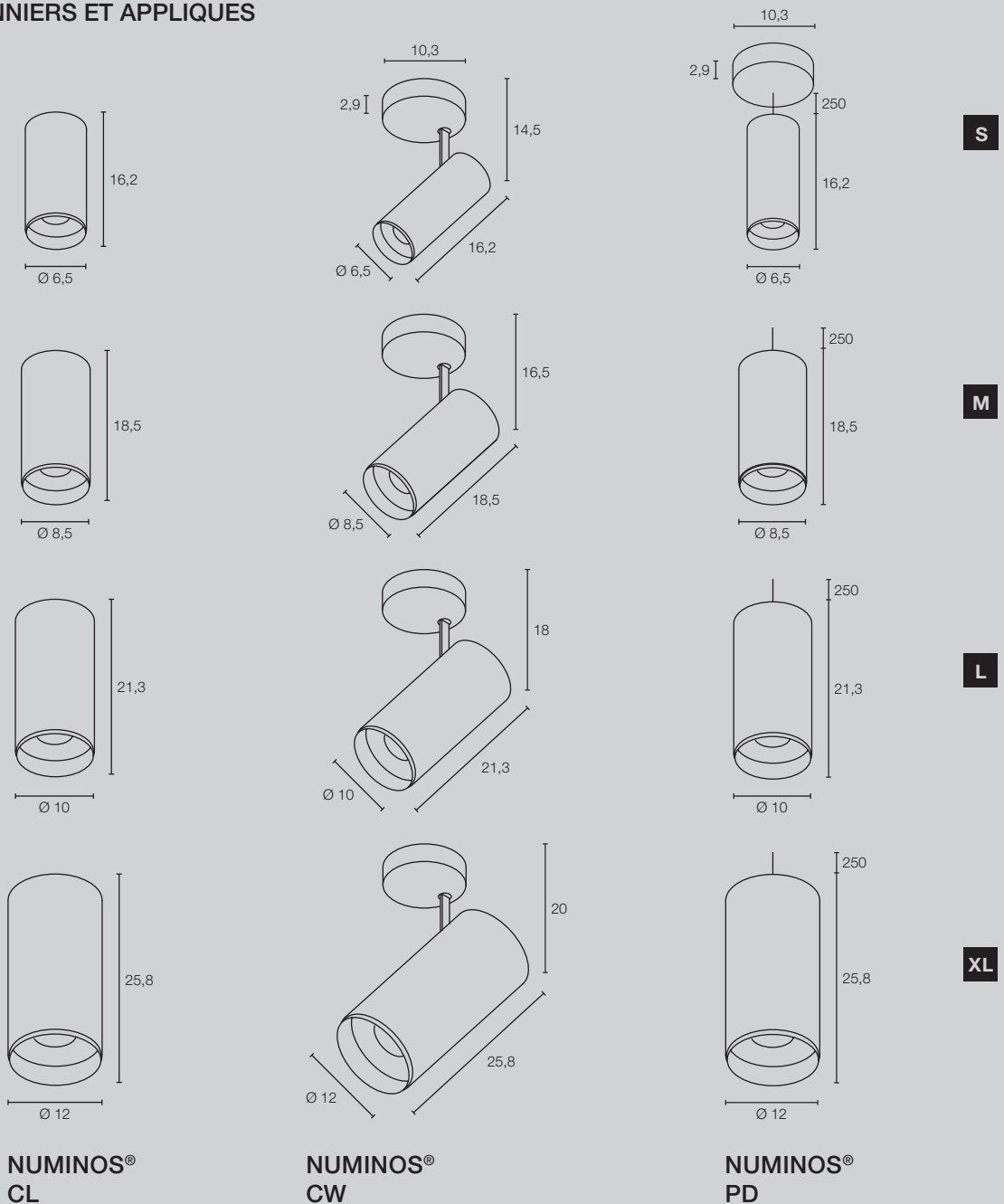
NUMINOS® ZOOM**PLAFONNIERS ET APPLIQUES****NUMINOS®
CL****NUMINOS®
CW****NUMINOS®
PD**

NUMINOS®

DOWN-/SPOTLIGHTS



Découvrez le
configurateur
NUMINOS®
sur slv.com

Disponibles en sept versions
avec module LED haute
performance en trois tempé-
ratures de couleur et trois
indices d'éblouissement.

Sélection de réflecteurs
à angles de rayonnement
de 20° à 55°.

Différents diffuseurs disponibles
en tant qu'accessoires.

Anneau de finition apparent.

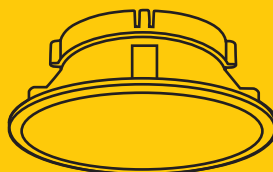
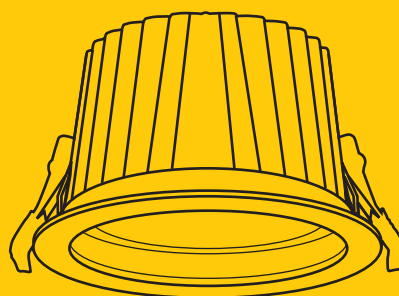

DOWNLIGHTS

Les downlights NUMINOS® sont disponibles en version fixe ou orientable.

NUMINOS® UN SYSTÈME D'ÉCLAIRAGE – MILLE POSSIBILITÉS. Un système d'éclairage entièrement configurable qui montre chaque environnement sous son meilleur jour. Chaque projet est différent et nombreux sont ceux qui exigent un concept d'éclairage au design coordonné. NUMINOS® est un système parfaitement cohérent qui concilie fonctionnalité, design et technologie. Pour les concepteurs de lumière et les installateurs. Pour tous les besoins. Pour un maximum de choix et un minimum d'effort.

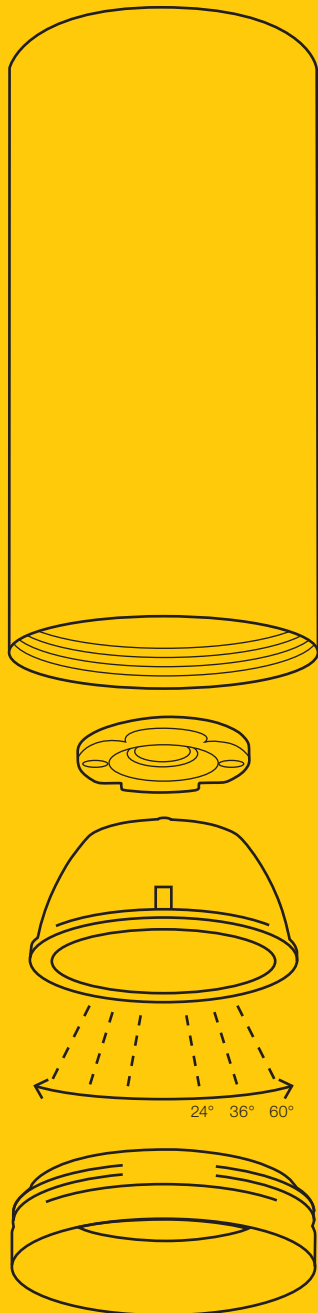

Disponibles en quatre tailles de boîtier avec module LED haute puissance en trois températures de couleur.

Grâce au driver LED intégré, tous les appareils sont adaptés à un raccordement direct en 230V.

Sélection de réflecteurs à angles de rayonnement de 24° à 60°.

Anneau de finition apparent.

SPOTLIGHTS

Les luminaires NUMINOS® sont disponibles sous forme de plafonniers fixes ou orientables, de suspensions et de spots pour rails 3 allumages.

NEW TRIA®
1007334

COMBINEZ



Douille GU10 ou module LED

+



Collettte de montage en coloris
noir, blanc, or rose ou aluminium

=





NEW TRIA® Downlight (DL)



NEW



Système modulaire plug & play pour une flexibilité maximale



Indice de rendu des couleurs exceptionnel > 90



Version
IP65

Installation facile grâce au boîtier Quick Connector



KITS NEW TRIA® .

Retrouvez nos best-sellers déjà combinés en kits aux pages 132-139

MODULES LED POUR COLLERETTES À DIAMÈTRE D'ENCASTREMENT 68 ET 75 mm.



NEW TRIA® DL, Module LED, Phase



220-240 V ~50/60 Hz
Matière : aluminium

●	●	C.L.	IP20	200mA	8,3W	2700K	705lm	1007381	●	51.80 CHF
						3000K	750lm	1007383	●	51.80 CHF



NEW TRIA® DL, Module LED, Phase



220-240 V ~50/60 Hz
Matière : aluminium

●	●	C.L.	IP20	200mA	8,3W	2700K	705lm	1007382	●	51.80 CHF
						3000K	750lm	1007384	●	51.80 CHF



MODULES DIM-TO-WARM POUR COLLERETTES À DIAMÈTRE D'ENCASTREMENT 68 ET 75 mm.

NEW TRIA® DL, Module LED, DTW, Phase



220-240 V ~50/60 Hz
Matière : aluminium

●	●	C.L.	IP20	250mA	11W	1800 - 3000K	700lm	1007421	●	64.40 CHF
---	---	------	------	-------	-----	--------------	-------	---------	---	-----------



NEW TRIA® DL, Module LED, DTW, Phase



220-240 V ~50/60 Hz
Matière : aluminium

●	●	C.L.	IP20	250mA	11W	1800 - 3000 K	700lm	1007422	●	64.40 CHF
---	---	------	------	-------	-----	---------------	-------	---------	---	-----------



DIM-TO-WARM (DTW)

La fonction Dim to warm permet de régler la température de couleur et la luminosité des luminaires. Par cette variation, la lumière passe d'une teinte claire et froide à un ton doux et chaud.

Toutes les puissances indiquées font référence à la puissance totale.
Retrouvez toutes les dimensions et informations de montage détaillées en pages 128-129



MODULES MULTI-PUISSANCE 3 CCT POUR COLLERETTES À DIAMÈTRE D'ENCASTREMENT 68 ET 75 mm.

NEW TRIA® UNIVERSAL DL, Module LED, Phase



220-240 V ~50/60 Hz
Matière : aluminium

● ○ IP20 100 - 180mA 4,6 - 8,6W CCT 2500 / 3000 / 4000K 540 / 600 / 600lm 1007431 ● 87.40 CHF



NEW TRIA® UNIVERSAL DL, Module LED, Phase



220-240 V ~50/60 Hz
Matière : aluminium

● ○ IP20 100 - 180mA 4,6 - 8,6W CCT 2500 / 3000 / 4000K 540 / 600 / 600lm 1007432 ● 87.40 CHF



MODULE GU10 POUR COLLERETTES À DIAMÈTRE D'ENCASTREMENT 68 ET 75 mm.

GU10 LED CONNECTION BOX Avec douille



220-240 V ~50/60 Hz
Matière : aluminium

● - IP20 - <10W - - 1007283 ● 6.90 CHF



Sources compatibles disponibles en page 860

MODULES LED POUR COLLERETTES À DIAMÈTRE D'ENCASTREMENT 95 mm.

NEW TRIA® DL, Module LED, Phase



220-240 V ~50/60 Hz
Matière : aluminium

● ○ IP20 350mA 13,3W 2700K 1130lm 1007409 ● 109.30 CHF
● ○ IP20 350mA 13,3W 3000K 1200lm 1007410 ● 109.30 CHF



NEW TRIA® DL, Module LED, Phase



220-240 V ~50/60 Hz
Matière : aluminium













● ○ IP20 350mA 13,3W 2700K 1130lm 1007411 ● 109.30 CHF
● ○ IP20 350mA 13,3W 3000K 1200lm 1007412 ● 109.30 CHF





SÉLECTIONNEZ VOTRE COLLERETTE DE MONTAGE :



COMPATIBLE AVEC TOUS LES MODULES DE 68/75 mm DE DIAMÈTRE ET DOUILLE GU10

	noir				1007332	17.10 CHF	
NEW TRIA® 68 <i>Collerette ronde, modules GU10/LED</i>	blanc	IP20	Ø : 8,2 cm, H : 2,6 cm		1007333	17.10 CHF	
	or rose				1007334	28.60 CHF	
	aluminium				1007335	22.90 CHF	
NEW TRIA® 68 <i>Collerette carrée, modules GU10/LED</i>	noir	IP20	L : 8,2 cm, l : 8,2 cm, H : 2,6 cm		1007329	17.10 CHF	
	blanc				1007328	17.10 CHF	
	or rose				1007331	28.60 CHF	
	aluminium				1007330	22.90 CHF	
NEW TRIA® 68 <i>Collerette ronde, modules GU10/LED</i>	noir	IP20	Ø : 8,2 cm, H : 4,4 cm		1007451	18.30 CHF	
	blanc				1007453	18.30 CHF	
NEW TRIA® 68 <i>Collerette ronde, modules GU10/LED</i>	noir	IP65	Ø : 8,2 cm, H : 3,4 cm		1007345	28.60 CHF	
	blanc				1007346	28.60 CHF	
NEW TRIA® 68 <i>Collerette carrée, modules GU10/LED</i>	noir	IP65	L : 8,2 cm, l : 8,2 cm, H : 3,4 cm		1007347	28.60 CHF	
	blanc				1007348	28.60 CHF	
NEW TRIA® 68 <i>Collerette ronde, modules GU10/LED, avec verre décoratif</i>	noir	IP65	Ø : 8,3 cm, H : 3,6 cm		1007336	41.30 CHF	
	blanc				1007337	41.30 CHF	
NEW TRIA® 68 <i>Collerette carrée, modules GU10/LED, avec verre décoratif</i>	noir	IP65	L : 8,3 cm, l : 8,3 cm, H : 3,6 cm		1007338	41.30 CHF	
	blanc				1007339	41.30 CHF	
NEW TRIA® 75 <i>Collerette ronde, modules GU10/LED</i>	noir	IP20	Ø : 9,3 cm, H : 2,6 cm		1007343	22.90 CHF	
	blanc				1007342	22.90 CHF	
	or rose				1007344	33.20 CHF	
	aluminium				1007351	27.50 CHF	
NEW TRIA® 75 <i>Collerette carrée, modules GU10/LED</i>	noir	IP20	L : 9 cm, l : 9 cm, H : 2,6 cm		1007340	22.90 CHF	
	blanc				1007349	22.90 CHF	
	or rose				1007341	33.20 CHF	
	aluminium				1007350	27.50 CHF	
NEW TRIA® 75 <i>Collerette ronde, modules GU10/LED En retrait avec collerette</i>	noir	IP20	Ø : 8,2 cm, H : 4,9 cm		1007449	21.70 CHF	
	blanc				1007450	21.70 CHF	
NEW TRIA® 75 <i>Collerette ronde, modules GU10/LED En retrait</i>	noir	IP20	Ø : 8,2 cm, H : 4,3 cm		1007488	17.10 CHF	
	blanc				1007489	17.10 CHF	
NEW TRIA® 75 XL <i>Collerette ronde, modules GU10/LED</i>	noir	IP20	Ø : 11 cm, H : 2,6 cm		1007631	28.60 CHF	
	blanc				1007630	28.60 CHF	
	or rose				1007633	39.00 CHF	
	aluminium				1007632	33.20 CHF	
NEW TRIA® 75 XL <i>Collerette carrée, modules GU10/LED</i>	noir	IP20	L : 11 cm, l : 11 cm, H : 2,6 cm		1007635	28.60 CHF	
	blanc				1007634	28.60 CHF	
	or rose				1007637	39.00 CHF	
	aluminium				1007636	33.20 CHF	

COMPATIBLE AVEC TOUS LES MODULES DE 95 mm DE DIAMÈTRE

	noir				1007444	34.40 CHF	
NEW TRIA® 95 <i>Collerette ronde, modules LED</i>	blanc	IP20	Ø : 11 cm, H : 2,6 cm		1007443	34.40 CHF	
	or rose				1007447	45.90 CHF	
	aluminium				1007445	40.10 CHF	
NEW TRIA® 95 <i>Collerette ronde, modules LED</i>	noir	IP20	Ø : 10,3 cm H : 5,5 cm		1007452	34.40 CHF	
	blanc				1007454	34.40 CHF	
NEW TRIA® 95 <i>Collerette ronde, modules LED</i>	noir	IP20	L : 11 cm, l : 11 cm, H : 2,6 cm		1007446	34.40 CHF	
	blanc				1007448	34.40 CHF	



Avec verre décoratif



Orientable à 30°

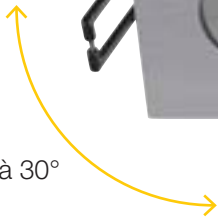

Orientable et inclinable à 30°



En retrait avec collerette



En retrait

NEW TRIA® TAILLES

MODULES LED POUR COLLERETTES À DIAMÈTRE D'ENCASTREMENT 68 et 75 mm.

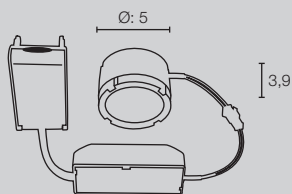

1007381 - 384

NEW TRIA®
DL, MODULE LED, PHASE

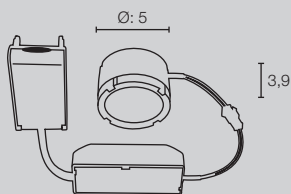

1007421 - 422

NEW TRIA®
DL, MODULE LED, DTW, PHASE

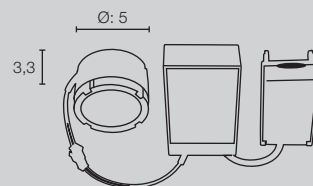

1007431 - 432

NEW TRIA® UNIVERSAL
DL, MODULE LED, PHASE

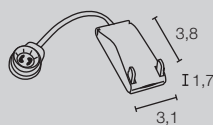

1007283

GU10 LED CONNECTION BOX
AVEC DOUILLE

MODULES LED POUR COLLERETTES
À DIAMÈTRE D'ENCASTREMENT 95 mm.

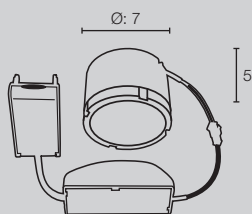

1007409, 1007410 - 412

NEW TRIA®
DL, MODULE LED, PHASE

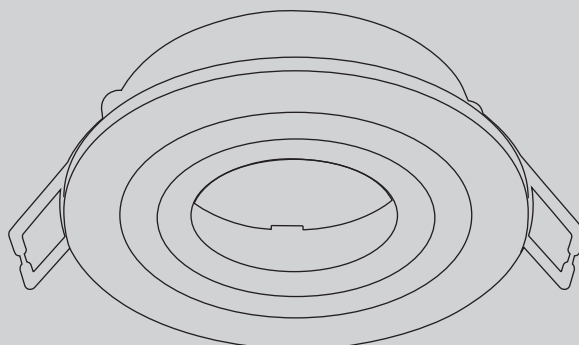
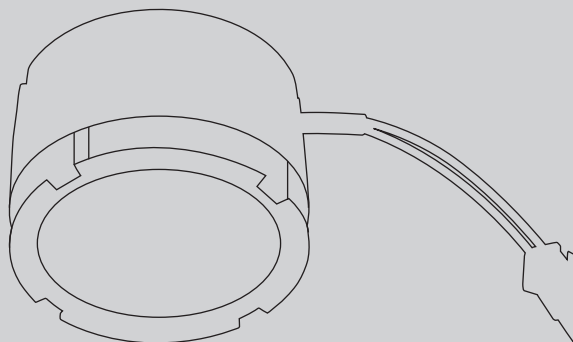

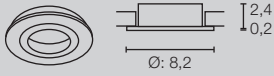

Ø d'encastrement : 6,8 cm
1007332 - 335

NEW TRIA® 68
COLLERETTE, ROND,
MODULES GU10/LED

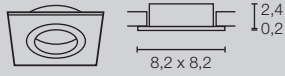

Ø d'encastrement : 6,8 cm
1007328 - 331

NEW TRIA® 68
COLLERETTE, CARRÉ,
MODULES GU10/LED

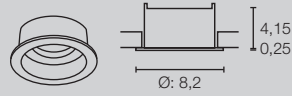

Ø d'encastrement : 6,8 cm
1007451, 1007453

NEW TRIA® 68
COLLERETTE, ROND,
MODULES GU10/LED

Version
IP65

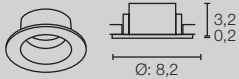

Ø d'encastrement : 6,8 cm
1007345 - 346

NEW TRIA® 68
COLLERETTE, ROND,
MODULES GU10/LED

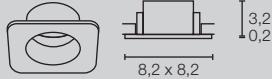

Ø d'encastrement : 6,8 cm
1007347 - 348

NEW TRIA® 68
COLLERETTE, CARRÉ,
MODULES GU10/LED

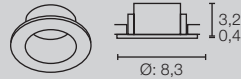

Ø d'encastrement : 6,8 cm
1007336 - 337

NEW TRIA® 68
COLLERETTE, ROND,
MODULES GU10/LED

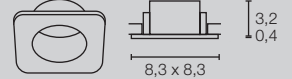

Ø d'encastrement : 6,8 cm
1007338 - 339

NEW TRIA® 68
COLLERETTE, CARRÉ,
MODULES GU10/LED

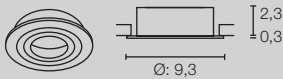

Ø d'encastrement : 7,5 cm
1007342 - 344, 1007351

NEW TRIA® 75
COLLERETTE, ROND,
MODULES GU10/LED

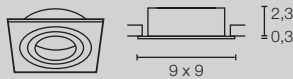

Ø d'encastrement : 7,5 cm
1007340 - 341, 1007349 - 350

NEW TRIA® 75
COLLERETTE, CARRÉ,
MODULES GU10/LED

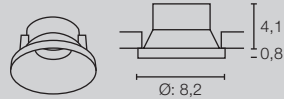

Ø d'encastrement : 7,5 cm
1007449 - 450

NEW TRIA® 75
COLLERETTE, ROND,
MODULES GU10/LED

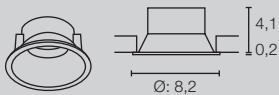

Ø d'encastrement : 7,5 cm
1007488 - 489

NEW TRIA® 75
COLLERETTE, ROND,
MODULES GU10/LED

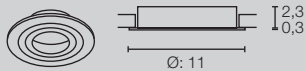

Ø d'encastrement : 7,5 cm
1007630 - 633

NEW TRIA® 75 XL
COLLERETTE, ROND,
MODULES GU10/LED

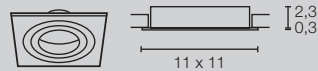

Ø d'encastrement : 7,5 cm
1007634 - 637

NEW TRIA® 75 XL
COLLERETTE, CARRÉ,
MODULES GU10/LED

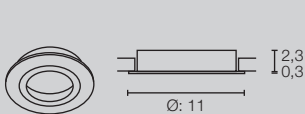

Ø d'encastrement : 9,5 cm
1007443 - 445, 1007447

NEW TRIA® 95
COLLERETTE, ROND, MODULES LED

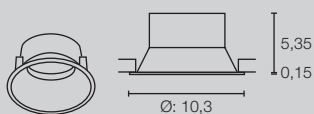

Ø d'encastrement : 9,5 cm
1007452, 1007454

NEW TRIA® 95
COLLERETTE, ROND, MODULES LED

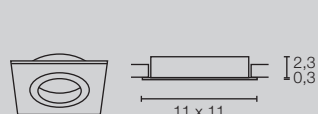

Ø d'encastrement : 9,5 cm
1007446, 1007448

NEW TRIA® 95
COLLERETTE, CARRÉ, MODULES LED

CONFIGUREZ VOS NEW TRIA®

Plus de modularité pour une flexibilité renforcée : cette mise à jour de la série de downlights NEW TRIA® met en lumière de nouvelles opportunités créatives. Choisissez simplement les options adéquates et profitez d'une installation rapide.

CHOISISSEZ VOTRE COLLERETTE DE MONTAGE ...

- ① Utilisation [*orientable, orientable et inclinable, IP65*
découpe de 68, 75 ou 95 mm de diamètre
- ② Coloris
noir, blanc, or rose ou aluminium
- ③ Forme ronde ou carrée

SÉLECTIONNEZ VOTRE MODULE ...

- ① Ø 68 / 75 ou 95 mm
- ② Température de couleur
2700K ou 3000K, 1800–3000K ou CCT 2500 / 3000 / 4000K
- ③ Angle de rayonnement
38° / 60°

LE TOUR EST JOUÉ !



Collerette de montage



Disponible en version orientable seulement, orientable et inclinable ou IP65 avec un diamètre de 68, 75 ou 95 mm



Coloris noir, blanc, or rose ou aluminium



Forme ronde ou carrée

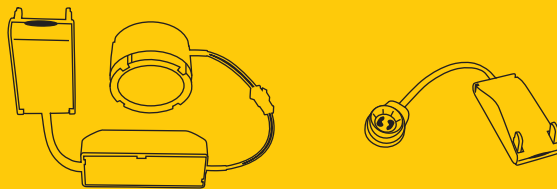

MODULE LED

GU10

NEW TRIA® 68

NEW TRIA® 75

NEW TRIA® 95



Température de couleur
2700 / 3000K, DTW 1800 - 3000K ou multi



Angle de rayonnement
38° / 60°

NEW TRIA® 68
1007388



NEW TRIA® Downlight (DL)



NEW

Version
GU10NEW TRIA® 75
DL, rond, QPAR51NEW TRIA® 68
DL, rond, PhaseVersion
IP65NEW TRIA® 68
DL, carré, PhaseNEW TRIA® 75
DL, carré, QPAR51Version
DTWNEW TRIA® 68
DL, rond, DTW, Phase

KITS NEW TRIA® .

Tous les kits NEW TRIA® sont constitués de composants parfaitement coordonnés pour une installation facile et rapide. Version Dim-to-warm, multi-CCT ou GU10 : avec les kits NEW TRIA®, vous avez l'équipement idéal.

NEW

KITS COMPLETS (COLLERETTE DE MONTAGE + MODULE LED)

NEW TRIA® 68 DL, rond, Phase



220-240 V ~50/60 Hz
Matière : aluminium

		IP20	200mA	8,3W	2700K	705lm	1007386	●	62.10 CHF
							1007385	●	62.10 CHF
		IP20	200mA	8,3W	3000K	750lm	1007390	●	62.10 CHF
							1007389	●	62.10 CHF



NEW TRIA® 68 DL, rond, Phase



220-240 V ~50/60 Hz
Matière : aluminium

		IP20	200mA	8,3W	2700K	705lm	1007388	●	62.10 CHF
							1007387	●	62.10 CHF
		IP20	200mA	8,3W	3000K	750lm	1007392	●	62.10 CHF
							1007391	●	62.10 CHF



NEW TRIA® 68 DL, carré, Phase



220-240 V ~50/60 Hz
Matière : aluminium

		IP20	200mA	8,3W	2700K	705lm	1007394	●	62.10 CHF
							1007393	●	62.10 CHF
		IP20	200mA	8,3W	3000K	750lm	1007398	●	62.10 CHF
							1007397	●	62.10 CHF



NEW TRIA® 68 DL, carré, Phase



220-240 V ~50/60 Hz
Matière : aluminium

		IP20	200mA	8,3W	2700K	705lm	1007396	●	62.10 CHF
							1007395	●	62.10 CHF
		IP20	200mA	8,3W	3000K	750lm	1007400	●	62.10 CHF
							1007399	●	62.10 CHF



Toutes les puissances indiquées font référence à la puissance totale.

Retrouvez toutes les dimensions et informations de montage détaillées en pages 146-147



NEW TRIA® 68 DL, rond, Phase

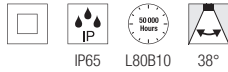

220-240 V ~50/60 Hz
Matière : aluminium

		IP65	200mA	8,3W	2700K	460lm	1007406 ●	79.40 CHF	
		IP65	200mA	8,3W	3000K	530lm	1007405 ●	79.40 CHF	
		IP65	200mA	8,3W	3000K	500lm	1007408 ●	79.40 CHF	
		IP65	200mA	8,3W	3000K	570lm	1007407 ●	79.40 CHF	

DIM-TO-WARM



NEW TRIA® 68 DL, rond, DTW, Phase



220-240 V ~50/60 Hz
Matière : aluminium

		IP20	250mA	11W	1800 - 3000K	700lm	1007424 ●	79.40 CHF	
		IP20	250mA	11W	1800 - 3000K	700lm	1007423 ●	79.40 CHF	

NEW TRIA® 68 DL, rond, DTW, Phase



220-240 V ~50/60 Hz
Matière : aluminium

		IP20	250mA	11W	1800 - 3000K	700lm	1007426 ●	79.40 CHF	
		IP20	250mA	11W	1800 - 3000K	700lm	1007425 ●	79.40 CHF	

NEW TRIA® 68 DL, carré, DTW, Phase



220-240 V ~50/60 Hz
Matière : aluminium

		IP20	250mA	11W	1800 - 3000K	700lm	1007428 ●	79.40 CHF	
		IP20	250mA	11W	1800 - 3000K	700lm	1007427 ●	79.40 CHF	

NEW TRIA® 68 DL, carré, DTW, Phase



220-240 V ~50/60 Hz
Matière : aluminium

		IP20	250mA	11W	1800 - 3000K	700lm	1007430 ●	79.40 CHF	
		IP20	250mA	11W	1800 - 3000K	700lm	1007429 ●	79.40 CHF	



Multi-CCT / multi-puissance

NEW TRIA® UNIVERSAL 68
DL, rond, Phase



220-240 V ~50/60 Hz
Matière : aluminium

  IP20 100 - 180mA 4,6 - 8,6W CCT 2500 / 3000 / 4000K 540 / 600 / 600lm

1007434 ● 102.40 CHF
1007433 ● 102.40 CHF



NEW TRIA® UNIVERSAL 68
DL, rond, Phase



220-240 V ~50/60 Hz
Matière : aluminium

  IP20 100 - 180mA 4,6 - 8,6W CCT 2500 / 3000 / 4000K 540 / 600 / 600lm

1007436 ● 102.40 CHF
1007435 ● 102.40 CHF



NEW TRIA® UNIVERSAL 68
DL, carré, Phase



220-240 V ~50/60 Hz
Matière : aluminium

  IP20 100 - 180mA 4,6 - 8,6W CCT 2500 / 3000 / 4000K 540 / 600 / 600lm

1007438 ● 102.40 CHF
1007437 ● 102.40 CHF





NEW TRIA® UNIVERSAL 68

DL, carré, Phase



220-240 V ~50/60 Hz
Matière : aluminium

		IP20	100 - 180mA	4,6 - 8,6W	CCT 2500 / 3000 / 4000K	540 / 600 / 600lm	1007440 ● 102.40 CHF
							1007439 ● 102.40 CHF



NEW TRIA® UNIVERSAL 68

DL, rond, Phase

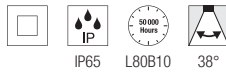

220-240 V ~50/60 Hz
Matière : aluminium

		IP65	100 - 180mA	4,6 - 8,6W	CCT 2500 / 3000 / 4000K	370 / 410 / 410lm	1007442 ● 113.90 CHF
						430 / 470 / 470lm	1007441 ● 113.90 CHF



NEW TRIA® 75

DL, rond, Phase



220-240 V ~50/60 Hz
Matière : aluminium

		IP20	200mA	8,3W	2700K	705lm	1007402 ● 73.60 CHF
							1007401 ● 73.60 CHF
		IP20	200mA	8,3W	3000K	750lm	1007404 ● 73.60 CHF
							1007403 ● 73.60 CHF



Toutes les puissances indiquées font référence à la puissance totale.

Retrouvez toutes les dimensions et informations de montage détaillées en pages 146-147

Kits complets (collette de montage + douille GU10)



NEW TRIA® 68 DL, rond, QPAR51



220-240 V ~50/60 Hz
Matière : aluminium



- IP20 - <10W 1xGU10 -

1007369 ● 22.90 CHF
1007368 ● 22.90 CHF
1007370 ● 29.80 CHF



NEW TRIA® 68 DL, carré, QPAR51

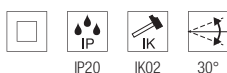

220-240 V ~50/60 Hz
Matière : aluminium



- IP20 - <10W 1xGU10 -

1007372 ● 22.90 CHF
1007371 ● 22.90 CHF
1007373 ● 29.80 CHF



NEW TRIA® 75 DL, rond, QPAR51

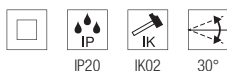

220-240 V ~50/60 Hz
Matière : aluminium



- IP20 - <10W 1xGU10 -

1007375 ● 29.80 CHF
1007374 ● 29.80 CHF
1007376 ● 34.40 CHF



NEW TRIA® 75 DL, carré, QPAR51

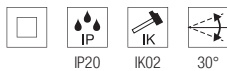

220-240 V ~50/60 Hz
Matière : aluminium



- IP20 - <10W 1xGU10 -

1007378 ● 29.80 CHF
1007377 ● 29.80 CHF
1007379 ● 34.40 CHF





NEW TRIA® 75 XL
DL, rond, QPAR51

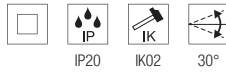

220-240 V ~50/60 Hz
Matière : aluminium



IP20

-

<10W

1xGU10

-

1007625	●	35.50 CHF
1007624	●	35.50 CHF
1007626	●	40.10 CHF



NEW TRIA® 75 XL
DL, carré, QPAR51



220-240 V ~50/60 Hz
Matière : aluminium



IP20

-

<10W

1xGU10

-

1007628	●	35.50 CHF
1007627	●	35.50 CHF
1007629	●	40.10 CHF



LED GU10
38°, CEE = F, 6kWh/1000h



6W

2700K

450lm

51 mm

1005077

10.60 CHF



NEW TRIA®
113890

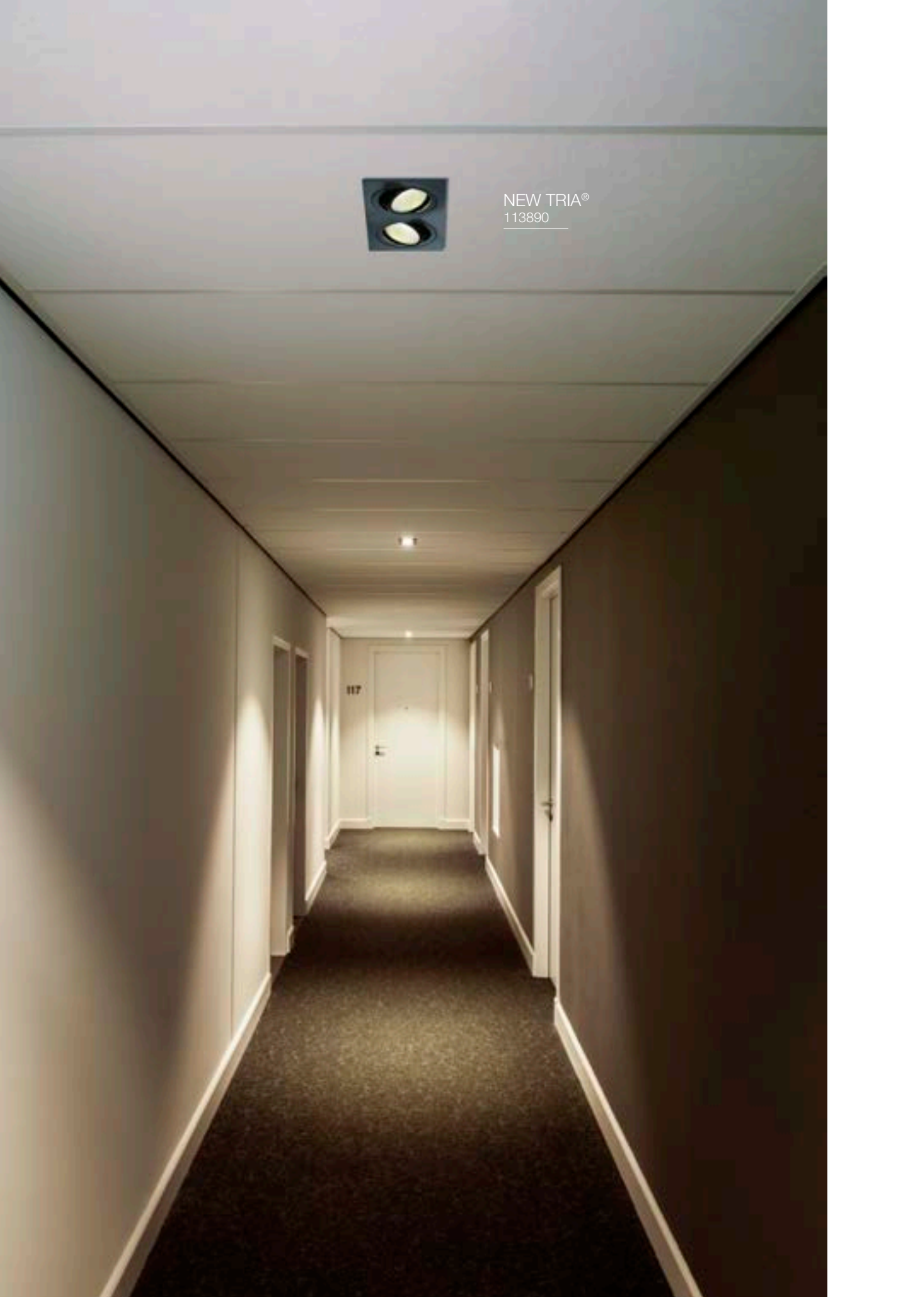



NEW TRIA®
Downlight (DL)



NEW TRIA® 155
DL, Double



NEW TRIA® 45
DL, rond



NEW TRIA® 45
DL, rond

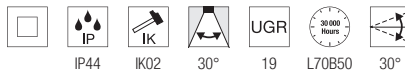

220-240 V ~50/60 Hz
Matière : aluminium



- IP44 700mA 3,4W 3000K 190lm

113970	70.00 CHF
113971	70.00 CHF
113976	85.00 CHF



NEW TRIA® 155
DL, Double

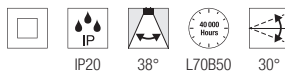

220-240 V ~50/60 Hz
Matière : aluminium



- IP20 350mA 14W 2700K 1160lm

113890	149.00 CHF
113891	149.00 CHF



Retrouvez toutes les dimensions et informations de montage détaillées en pages 146-147

NEW TRIA®
113550





NEW TRIA® Downlight (DL)

**SOCKET
INSIDE**

NEW TRIA® 150
DL, rond



NEW TRIA® 150
DL, carré



NEW TRIA® 155
DL, Double



NEW TRIA® 300
DL, Double



NEW TRIA®
113840

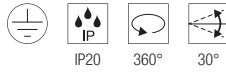

**NEW TRIA® 150**
DL, rond, QPAR111220-240 V ~50/60 Hz
Matière : aluminium

	-	IP20	-	<75W	1xGU10	-	113550	74.00 CHF	
							113540	74.00 CHF	

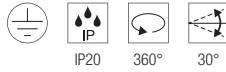
NEW TRIA® 150
DL, carré, QPAR111220-240 V ~50/60 Hz
Matière : aluminium

	-	IP20	-	<75W	1xGU10	-	113830	74.00 CHF	
							113541	74.00 CHF	

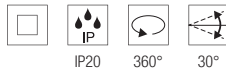

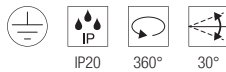

NEW TRIA® 155
DL, Double, QPAR51220-240 V ~50/60 Hz
Matière : aluminium

	-	IP20	-	<50W	2xGU10	-	113492	70.00 CHF	
							113512	70.00 CHF	
							111362	74.00 CHF	

NEW TRIA® 300
DL, Double, QPAR111220-240 V ~50/60 Hz
Matière : aluminium

	-	IP20	-	<75W	2xGU10	-	113840	149.00 CHF	
							113841	149.00 CHF	
							111382	149.00 CHF	



LED GU10 38°, CEE = F, 6kWh/1000h Pour NEW TRIA® 155		6W	2700K	450lm	51 mm	1005077	10.60 CHF
QPAR111 38°, CEE = F, 8kWh/1000h Pour NEW TRIA® 150/300		8W	2700K	680lm	-	1005274	35.20 CHF
LED GU10 40°, CEE = G, 8kWh/1000h Pour NEW TRIA® 150/300		7,3W	2700K	500lm	111 mm	1005294	24.50 CHF
QPAR111 30°, CEE = F, 13kWh/1000h Pour NEW TRIA® 150/300		12,5W	2700K	950lm	-	1005276	62.00 CHF

NEW TRIA® TAILLES

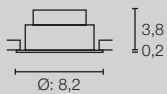

Dimensions d'encastrement :
Ø : 6,8 cm P : 4 cm

NEW TRIA® 68
DL, ROND, PHASE

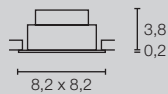

Dimensions d'encastrement :
Ø : 6,8 cm P : 4 cm

NEW TRIA® 68
DL, CARRÉ, PHASE

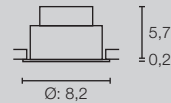

Dimensions d'encastrement :
Ø : 6,8 cm P : 6 cm

NEW TRIA® 68
DL, ROND, PHASE

Version
IP65

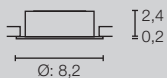

Dimensions d'encastrement :
Ø : 6,8 cm P : 6,5 cm

NEW TRIA® 68
DL, ROND, QPAR51

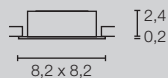

Dimensions d'encastrement :
Ø : 6,8 cm P : 6,5 cm

NEW TRIA® 68
DL, CARRÉ, QPAR51

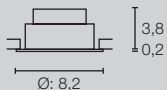

Dimensions d'encastrement :
Ø : 6,8 cm P : 4,5 cm

NEW TRIA® 68
DL, ROND, DTW, PHASE

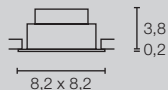

Dimensions d'encastrement :
Ø : 6,8 cm P : 4,5 cm

NEW TRIA® 68
DL, CARRÉ, DTW, PHASE

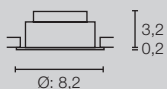

Dimensions d'encastrement :
Ø : 6,8 cm P : 4 cm

NEW TRIA® UNIVERSAL 68
DL, ROND, PHASE

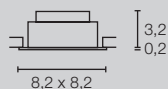

Dimensions d'encastrement :
Ø : 6,8 cm P : 4 cm

NEW TRIA® UNIVERSAL 68
DL, CARRÉ, PHASE

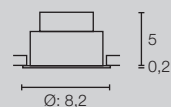

Dimensions d'encastrement :
Ø : 6,8 cm P : 5,5 cm

NEW TRIA® UNIVERSAL 68
DL, ROND, PHASE

Version
IP65

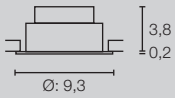

Dimensions d'encastrement :
 \varnothing : 7,5 cm P : 4 cm

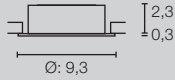

Dimensions d'encastrement :
 \varnothing : 7,5 cm P : 6,5 cm

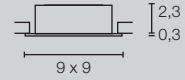

Dimensions d'encastrement :
 \varnothing : 7,5 cm P : 6,5 cm

NEW TRIA® 75
 DL, ROND, PHASE

NEW TRIA® 75
 DL, ROND, QPAR51

NEW TRIA® 75
 DL, CARRÉ, QPAR51

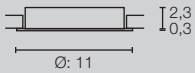

Dimensions d'encastrement :
 \varnothing : 7,5 cm P : 6,5 cm

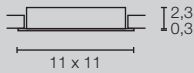

Dimensions d'encastrement :
 \varnothing : 7,5 cm P : 6,5 cm

NEW TRIA® 75 XL
 DL, ROND, QPAR51

NEW TRIA® 75 XL
 DL, CARRÉ, QPAR51

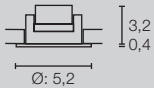

Dimensions d'encastrement :
 \varnothing : 4,5 cm P : 4 cm

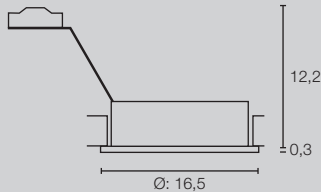

Dimensions d'encastrement :
 \varnothing : 15 cm P : 12,5 cm

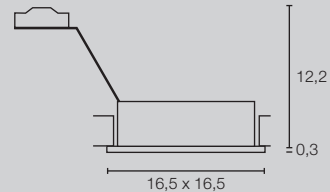

Dimensions d'encastrement :
 \varnothing : 15 cm P : 12,5 cm

NEW TRIA® 45
 DL, ROND

NEW TRIA® 150
 DL, ROND, QPAR111

NEW TRIA® 150
 DL, CARRÉ, QPAR111

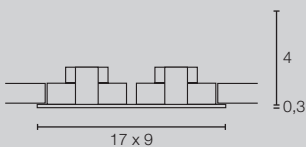

Dimensions d'encastrement :
 L : 15,5 cm, l : 8 cm P : 4 cm

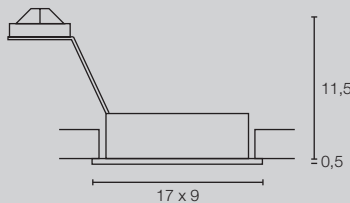

Dimensions d'encastrement :
 L : 15 cm, l : 7,8 cm, P : 12,5 cm

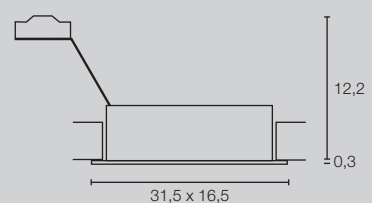

Dimensions d'encastrement :
 L : 30 cm, l : 15,5 cm, P : 12,5 cm

NEW TRIA® 155
 DL, DOUBLE

NEW TRIA® 155
 DL, DOUBLE, QPAR51

NEW TRIA® 300
 DL, DOUBLE, QPAR111

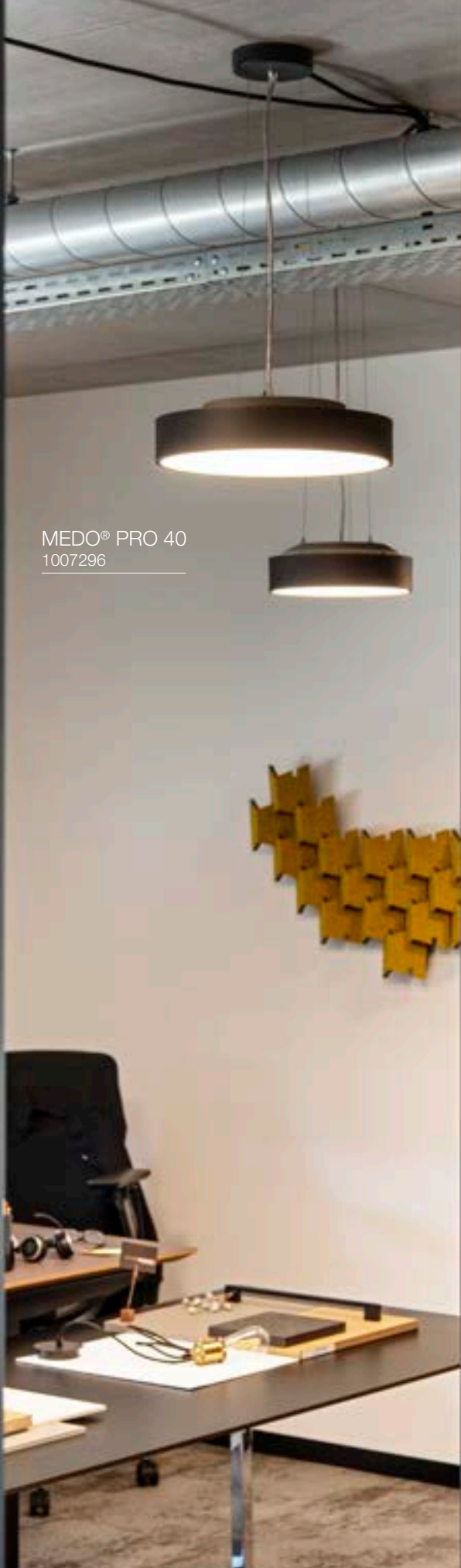

MEDO® PRO 40
1007296

Découvrez la famille MEDO®
au grand complet

NEW



MEDO® PRO CW



MEDO® PRO (DC) CW



MEDO® CW



MEDO® CL



MEDO® RING PD



MEDO® EL

MEDO® PRO

Appliques et plafonniers (CW)



NEW

Kit de suspension non fourni

Également disponible en version
prismatique à UGR < 19
anti-éblouissement

Indice de rendu des couleurs
exceptionnel (IRC) > 90

Sélection de la température de
couleur via interrupteur CCT
(3000 / 4000K)

La face arrière transparente
augmente la part de lumière
indirecte

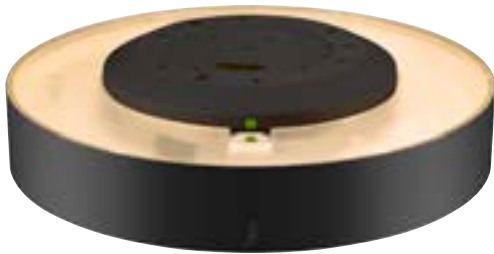

Installation très facile
et rapide grâce
à l'EasyBase

ÉCLAIRAGE D'AMBIANCE

*Les nouveaux modèles MEDO®
et leur sortie de lumière indirecte
font aussi briller les arrières-
plans. Vos espaces bénéficient
ainsi d'un éclairage agréable,
homogène et adouci.*

DIFFUSEUR PRISMATIQUE (UGR < 19)

MEDO® PRO 30 CW, DALI, UGR<19



220-240V ~50/60Hz
Matière : aluminium / polystyrène (PS)

		IP50	250mA	10W	CCT 3000 / 4000K	1250 / 1250lm	1007284 ● 378.40 CHF	
							1007285 ● 378.40 CHF	

MEDO® PRO 30 CW, Phase, UGR<19



220-240V ~50/60Hz
Matière : aluminium / polystyrène (PS)

		IP50	250mA	10W	CCT 3000 / 4000K	1250 / 1250lm	1007288 ● 343.90 CHF	
							1007289 ● 343.90 CHF	

MEDO® PRO 40 CW, DALI, UGR<19



220-240V ~50/60Hz
Matière : aluminium / polystyrène (PS)

		IP50	500mA	19W	CCT 3000 / 4000K	2400 / 2500lm	1007292 ● 516.40 CHF	
							1007293 ● 516.40 CHF	

MEDO® PRO 40 CW, Phase, UGR<19



220-240V ~50/60Hz
Matière : aluminium / polystyrène (PS)

		IP50	500mA	19W	CCT 3000 / 4000K	2400 / 2500lm	1007296 ● 401.40 CHF	
							1007297 ● 401.40 CHF	



MEDO® PRO 60
CW, DALI, UGR<19



220-240V ~50/60Hz
Matière : aluminium / polystyrène (PS)

		IP50	1000mA	39W	CCT 3000 / 4000K	5000 / 5100lm	1007300 ● 803.90 CHF	
							1007301 ● 803.90 CHF	

MEDO® PRO 60
CW, Phase, UGR<19



220-240V ~50/60Hz
Matière : aluminium / polystyrène (PS)

		IP50	1000mA	37W	CCT 3000 / 4000K	5000 / 5100lm	1007304 ● 723.40 CHF	
							1007305 ● 723.40 CHF	

MEDO® PRO 90
CL, DALI, UGR<19



220-240V ~50/60Hz
Matière : aluminium / polystyrène (PS)

		IP50	1000mA	75W	CCT 3000 / 4000K	9400 / 9700lm	1007308 ● 1'666.40 CHF	
							1007309 ● 1'666.40 CHF	

MEDO® PRO 90
CL, Phase, UGR<19



220-240V ~50/60Hz
Matière : aluminium / polystyrène (PS)

		IP50	1000mA	74W	CCT 3000 / 4000K	9400 / 9700lm	1007312 ● 1'436.40 CHF	
							1007313 ● 1'436.40 CHF	

Excellente efficacité énergétique

DIFFUSEUR OPALE (UGR < 25)

MEDO® PRO 30 CW, DALI



220-240V ~50/60Hz

Matière : aluminium / polystyrène (PS)

		IP50	250mA	10W	CCT 3000 / 4000K	1350 / 1350lm	1007286 ● 378.40 CHF	
							1007287 ● 378.40 CHF	

MEDO® PRO 30 CW, Phase



220-240V ~50/60Hz

Matière : aluminium / polystyrène (PS)

		IP50	250mA	10W	CCT 3000 / 4000K	1350 / 1350lm	1007290 ● 343.90 CHF	
							1007291 ● 343.90 CHF	

MEDO® PRO 40 CW, DALI



220-240V ~50/60Hz

Matière : aluminium / polystyrène (PS)

		IP50	500mA	19W	CCT 3000 / 4000K	2650 / 2650lm	1007294 ● 516.40 CHF	
							1007295 ● 516.40 CHF	

MEDO® PRO 40 CW, Phase



220-240V ~50/60Hz

Matière : aluminium / polystyrène (PS)

		IP50	500mA	19W	CCT 3000 / 4000K	2650 / 2650lm	1007298 ● 401.40 CHF	
							1007299 ● 401.40 CHF	





MEDO® PRO 60 CW, DALI



220-240V ~50/60Hz
Matière : aluminium / polystyrène (PS)

		IP50	1000mA	39W	CCT 3000 / 4000K	5450 / 5500lm	1007302 ● 803.90 CHF	
							1007303 ● 803.90 CHF	

MEDO® PRO 60 CW, Phase



220-240V ~50/60Hz
Matière : aluminium / polystyrène (PS)

		IP50	1000mA	37W	CCT 3000 / 4000K	5450 / 5500lm	1007306 ● 723.40 CHF	
							1007307 ● 723.40 CHF	

MEDO® PRO 90 CL, DALI



220-240V ~50/60Hz
Matière : aluminium / polystyrène (PS)

		IP50	1000mA	75W	CCT 3000 / 4000K	11000 / 11200lm	1007310 ● 1'666.40 CHF	
							1007311 ● 1'666.40 CHF	

MEDO® PRO 90 CL, Phase



220-240V ~50/60Hz
Matière : aluminium / polystyrène (PS)

		IP50	1000mA	74W	CCT 3000 / 4000K	11000 / 11200lm	1007314 ● 1'436.40 CHF	
							1007315 ● 1'436.40 CHF	



	noir	135250	55.00 CHF
Kit de suspension 1,5 m	blanc	135251	55.00 CHF
	gris	135254	55.00 CHF
	noir	1001952	127.00 CHF
Kit de suspension 5 m	blanc	1001950	127.00 CHF
	gris	1001951	127.00 CHF

MEDO® PRO 60
1006417 (DC)

MEDO® PRO 40
1006414 (DC)



ÉCLAIRAGE D'AMBIANCE

Les nouveaux modèles MEDO® et leur sortie de lumière indirecte font aussi briller les arrières-plans. Vos espaces bénéficient ainsi d'un éclairage agréable, homogène et adouci.

MEDO® PRO

Applique et plafonnier (CW), DC



NEW



Installation très facile et rapide grâce à l'EasyBase

Kit de suspension non fourni



Diffuseur prismatique à UGR < 19
anti-éblouissement

La face arrière transparente
augmente la part de
lumière indirecte

Indice de rendu de couleurs
exceptionnel (IRC) > 90

ÉCLAIRAGE DE SECOURS

Avec le MEDO® PRO DC, vous bénéficiez de tous les avantages techniques du MEDO® PRO en version prismatique avec UGR < 19. Grâce à son driver LED intégré compatible DC, vous avez l'assurance de continuer à voir où vous marchez en cas de coupure d'électricité.



MEDO® PRO 60
1006417 (DC)

MEDO® PRO 30
1006411 (DC)



Pour plus d'idées
d'aménagements
dans notre brochure
MEDO® .



MEDO® PRO 30 CW, DALI, UGR<19, DC



220-240V ~50/60Hz
Matière : aluminium / polystyrène (PS)

		IP50	250mA	10W	CCT 3000 / 4000K	1250 / 1250lm	1006411 ● 435.90 CHF
							1006412 ● 435.90 CHF



MEDO® PRO 40 CW, DALI, UGR<19, DC



220-240V ~50/60Hz
Matière : aluminium / polystyrène (PS)

		IP50	500mA	19W	CCT 3000 / 4000K	2400 / 2500lm	1006414 ● 516.40 CHF
							1006415 ● 516.40 CHF



MEDO® PRO 60 CW, DALI, UGR<19, DC



220-240V ~50/60Hz
Matière : aluminium / polystyrène (PS)

		IP50	1000mA	37W	CCT 3000 / 4000K	5000 / 5100lm	1006417 ● 861.40 CHF
							1006418 ● 861.40 CHF



MEDO® PRO 90 CL, DALI, UGR<19, DC



220-240V ~50/60Hz
Matière : aluminium / polystyrène (PS)

		IP50	1000mA	75W	CCT 3000 / 4000K	9400 / 9700lm	1006420 ● 1'781.40 CHF
							1006421 ● 1'781.40 CHF



Excellente efficacité
énergétique

⊕			
	noir	135250	55.00 CHF
Kit de suspension 1,5 m	blanc	135251	55.00 CHF
	gris	135254	55.00 CHF
	noir	1001952	127.00 CHF
Kit de suspension 5 m	blanc	1001950	127.00 CHF
	gris	1001951	127.00 CHF

MEDO® 60
1007322

MEDO® 90
1007325



ÉCLAIRAGE D'AMBIANCE

Les nouveaux modèles MEDO® et leur sortie de lumière indirecte font aussi briller les arrière-plans. Vos espaces bénéficient ainsi d'un éclairage agréable, homogène et adouci.

MEDO®
Appliques et plafonniers (CW)



NEW

Kit de suspension non fourni



Installation très facile
et rapide grâce
à l'EasyBase

Indice de rendu des couleurs
exceptionnel (IRC) > 90

Sélection de la température
de couleur via interrupteur CCT
(2700 / 3000 / 4000 K)

La face arrière transparente
augmente la part de lumière
indirecte



MEDO® 30
1007317





MEDO® 30 CW, Phase



220-240V ~50/60Hz
Matière : aluminium / polystyrène (PS)



IP50 250mA 12W CCT 2700 / 3000 / 4000K 1050 / 1100 / 1200lm

1007316 ● 304.80 CHF
1007317 ● 304.80 CHF
1007318 ● 304.80 CHF



MEDO® 40 CW, Phase



220-240V ~50/60Hz
Matière : aluminium / polystyrène (PS)



IP50 500mA 20W CCT 2700 / 3000 / 4000K 2100 / 2200 / 2350lm

1007319 ● 338.10 CHF
1007320 ● 338.10 CHF
1007321 ● 338.10 CHF



MEDO® 60 CW, Phase



220-240V ~50/60Hz
Matière : aluminium / polystyrène (PS)



IP50 1000mA 39W CCT 2700 / 3000 / 4000K 4050 / 4250 / 4550lm

1007322 ● 642.90 CHF
1007323 ● 642.90 CHF
1007324 ● 642.90 CHF



MEDO® 90 CL, Phase



220-240V ~50/60Hz
Matière : aluminium / polystyrène (PS)



IP50 1000mA 79W CCT 2700 / 3000 / 4000K 8300 / 8700 / 9350m

1007325 ● 1'263.90 CHF
1007326 ● 1'263.90 CHF
1007327 ● 1'263.90 CHF



Kit de suspension 1,5 m	noir	135250	55.00 CHF
	blanc	135251	55.00 CHF
	gris	135254	55.00 CHF
Kit de suspension 5 m	noir	1001952	127.00 CHF
	blanc	1001950	127.00 CHF
	gris	1001951	127.00 CHF

MEDO® : COMMENT LES INSTALLER

Grâce à l'EasyBase, installer les nouveaux modèles MEDO® devient un jeu d'enfant. L'EasyBase sert de patron très pratique pour le perçage des trous, mais elle permet aussi de poser le luminaire facilement en un tournemain. Après avoir fixé votre EasyBase à l'emplacement souhaité et procédé au câblage, vous pouvez régler la température de couleur via l'interrupteur CCT situé sur l'appareil. Clipsez ensuite le luminaire en tenant compte des marquages verts.

PLAFONNIERS

Vissez l'EasyBase au plafond

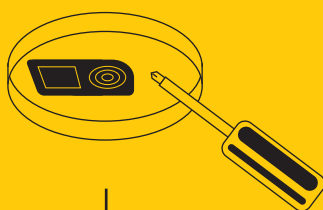

Procédez au câblage de l'EasyBase



Sélectionnez la température de couleur à l'aide de l'interrupteur CCT et clipsez le luminaire, en respectant les marquages verts

Une chaînette de sécurisation supplémentaire est fournie avec les modèles MEDO® 60 et MEDO® 90

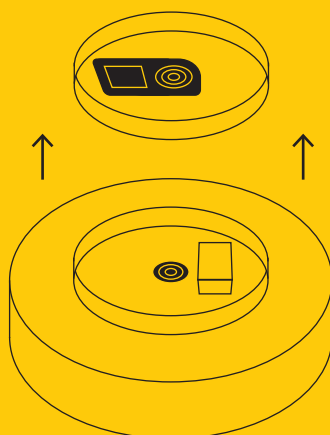

Installation très facile
et rapide grâce
à l'EasyBase

ENCASTRÉS SANS CADRE

ENCASTRÉS CADRE DE MONTAGE

Placez le pot d'encastrement
dans le plafond

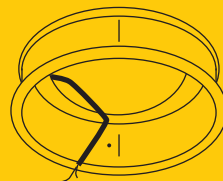

Positionnez les plaques
de montage et vissez-les

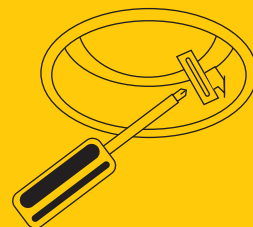
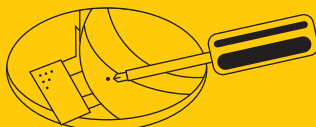

Vissez la plaque de montage
dans le plafond et recouvrez
avec de l'enduit

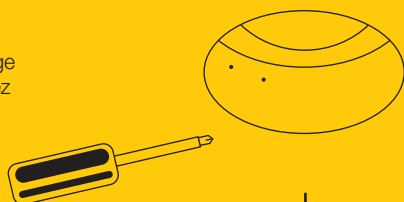

Raccordez le driver LED

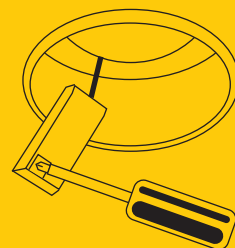
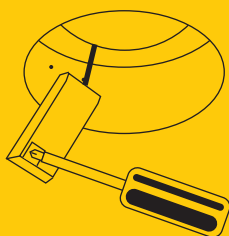

Mettez le module LED en place
et sélectionnez la température
de couleur via l'interrupteur CCT

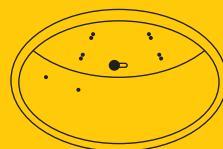

Placez le diffuseur



MEDO® 60
1002882

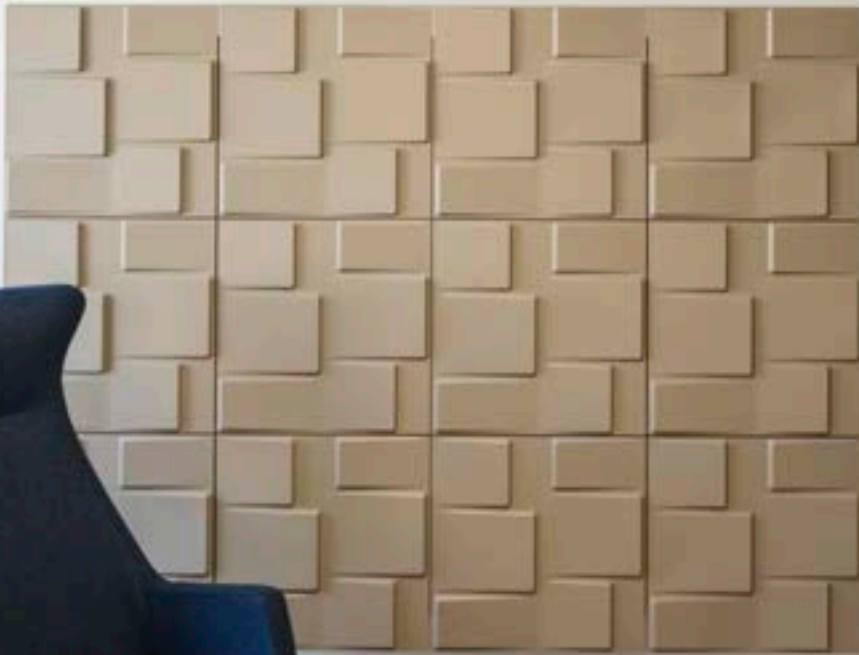
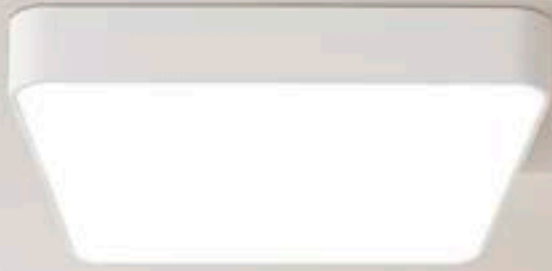



MEDO® Plafonniers (CL)



Kit de suspension non fourni



MEDO® 60 CL, carré, 1-10V



220-240V ~50/60Hz
Matière : aluminium / acrylique



IP20

1000mA

39W

3000K

3800lm

1000726

639.00 CHF

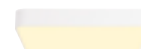

MEDO® 60 CL, carré, DALI



220-240V ~50/60Hz
Matière : aluminium / acrylique



IP20

1000mA

39W

3000K

3800lm

1002882

689.00 CHF



Kit de suspension 1,5 m	noir	135250	55.00 CHF
	blanc	135251	55.00 CHF
	gris	135254	55.00 CHF
Kit de suspension 5 m	noir	1001952	127.00 CHF
	blanc	1001950	127.00 CHF
	gris	1001951	127.00 CHF



MEDO® RING 60
133840





MEDO® RING Suspensions (PD)



MEDO® RING
en tailles 60 et 90

MEDO® RING 60 PD, 1-10V

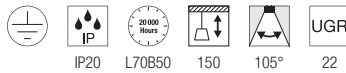

220-240V ~50/60Hz
Matière : aluminium / polyméthacrylate de méthyle (PMMA)

		IP20	700mA	33W	3000K	2200lm
--	--	------	-------	-----	-------	--------

133840	779.00 CHF
133841	779.00 CHF



MEDO® RING 90 PD, 1-10V

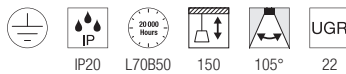

220-240V ~50/60Hz
Matière : aluminium / polyméthacrylate de méthyle (PMMA)

		IP20	1200mA	56W	3000K	4900lm
--	--	------	--------	-----	-------	--------

133850	929.00 CHF
133851	929.00 CHF



MEDO® RING 60 PD, DALI

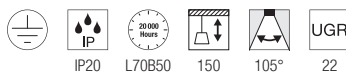

220-240V ~50/60Hz
Matière : aluminium / polyméthacrylate de méthyle (PMMA)

		IP20	700mA	34W	3000K	2200lm
--	--	------	-------	-----	-------	--------

1002890	839.00 CHF
1002891	839.00 CHF



MEDO® 60
1001907

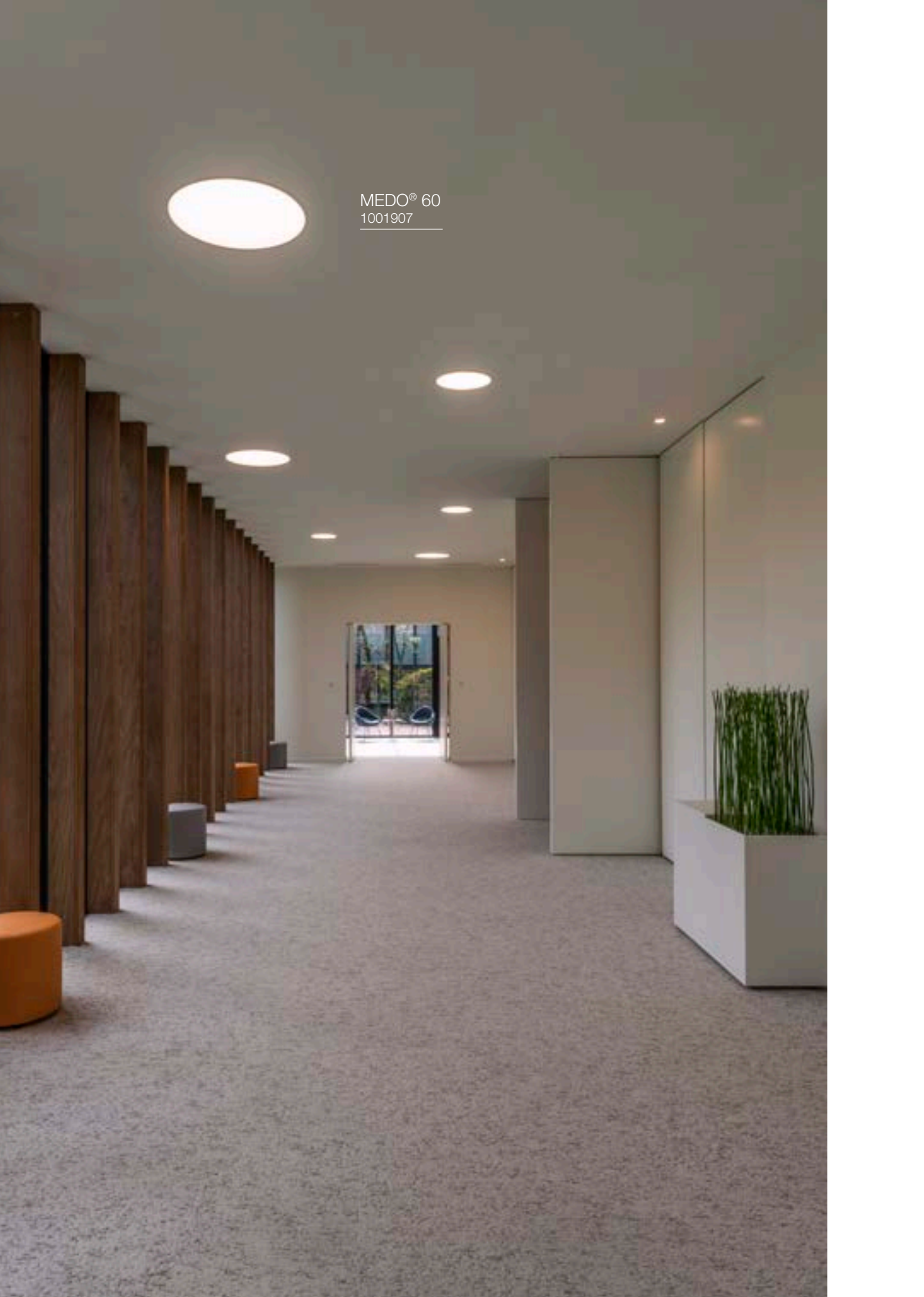



MEDO® Encastrés (EL)



MEDO® 30, 40 et 60
EL, sans cadre



MEDO® 30, 40 et 60
EL, cadre de montage



SANS CADRE

MEDO® 30 EL, Sans cadre



Matière : aluminium / polyméthacrylate de méthyle (PMMA)

○ - IP20 350mA 14W CCT 3000 / 4000K 1500 / 1600lm **1001901 245.00 CHF**



MEDO® 40 EL, Sans cadre



Matière : aluminium / polyméthacrylate de méthyle (PMMA)

○ - IP20 700mA 28W CCT 3000 / 4000K 3100 / 3300lm **1001902 275.00 CHF**



MEDO® 60 EL, Sans cadre



Matière : aluminium / polyméthacrylate de méthyle (PMMA)

○ - IP20 1000 / 1050mA 36W CCT 3000 / 4000K 4700 / 5000lm **1001903 579.00 CHF**



Les drivers LED ne sont pas fournis mais disponibles séparément. Retrouvez les drivers compatibles ici :





CADRE DE MONTAGE

MEDO® 30 EL, Cadre de montage



Matériau : aluminium / polyméthacrylate de méthyle (PMMA)

○ - IP20 350mA 14W CCT 3000 / 4000K 1500 / 1600lm **1001905 259.00 CHF**



MEDO® 40 EL, Cadre de montage

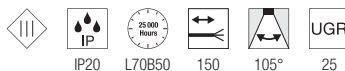

Matériau : aluminium / polyméthacrylate de méthyle (PMMA)

○ - IP20 700mA 28W CCT 3000 / 4000K 3100 / 3300lm **1001906 289.00 CHF**



MEDO® 60 EL, Cadre de montage



Matériau : aluminium / polyméthacrylate de méthyle (PMMA)

○ - IP20 1000 / 1050mA 38W CCT 3000 / 4000K 4700 / 5000lm **1001907 649.00 CHF**



DRIVERS LED



DRIVER LED 250-700mA, 1-10V / DALI AVEC SERRE-CÂBLE MEDO® 30 + 60	blanc	20W	1-10V / DALI		L : 15 cm, l : 5,2 cm, H : 2,8 cm	1002423	117.00 CHF
DRIVER LED 500-1050mA, 1-10V / DALI AVEC SERRE-CÂBLE MEDO® 40	blanc	40W	1-10V / DALI		L : 14,2 cm, l : 4,4 cm, H : 3 cm	1002424	117.00 CHF
DRIVER LED 700mA AVEC SERRE-CÂBLE MEDO® 40	blanc	40W	C	-	L : 14,5 cm, l : 4 cm, H : 3 cm	1005446	55.00 CHF
DRIVER LED 1050mA AVEC SERRE-CÂBLE MEDO® 30 + 60	blanc	40W	C		L : 16,6 cm, l : 5,2 cm, H : 2,4 cm	464804	70.00 CHF
DRIVER LED 700 / 900 / 1000mA AVEC SERRE-CÂBLE MEDO® 30 + 40 + 60	blanc	40W	-		L : 12,3 cm, l : 7,9 cm, H : 3 cm	1006120	65.00 CHF

MEDO®

APERÇU



MEDO® PRO
CW



MEDO® PRO (DC)
CW



MEDO®
CW

Tailles	30 40 60 90	30 40 60 90	30 40 60 90
Kit de suspension	1,5 5 m (non incl.)	1,5 5 m (non incl.)	1,5 5 m (non incl.)
EasyBase	✓	✓	✓
Interrupteur CCT	✓	✓	✓
DALI	✓	✓	-
Phase	C	-	C
1-10 V	-	-	-
UGR	19 25	19	22 25
DC	-	✓	-

Les drivers LED ne sont pas fournis mais disponibles séparément



MEDO®
CL, CARRÉ

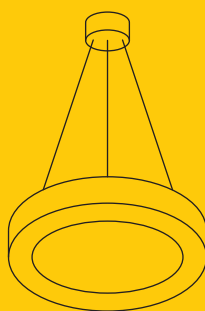

MEDO® RING
PD

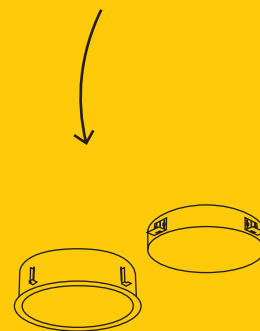

MEDO®
EL, SANS CADRE | CADRE DE MONTAGE

	60	60	30 40 60
	1,5 5 m (non incl.)	1,5 m (incl.)	-
	-	-	-
	-	-	✓
	✓	✓	✓*
	-	-	✓*
	✓	✓	✓*
	22	22	25
	-	-	-

*En fonction du driver

MEDO® TAILLES

ENCASTRÉS

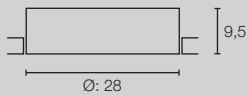

Dimensions d'encastrement :
Ø : 29 cm P : 13 cm

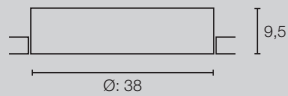

Dimensions d'encastrement :
Ø : 39 cm P : 13 cm

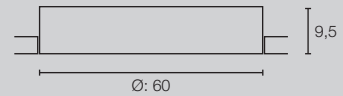

Dimensions d'encastrement :
Ø : 61 cm P : 16 cm

MEDO® 30 EL, SANS CADRE

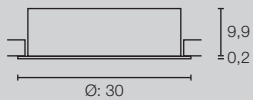

Dimensions d'encastrement :
Ø : 29 cm P : 13 cm

MEDO® 40 EL, SANS CADRE

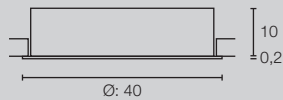

Dimensions d'encastrement :
Ø : 39 cm P : 13 cm

MEDO® 60 EL, SANS CADRE

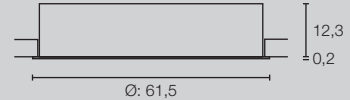

Dimensions d'encastrement :
Ø : 61 cm P : 16 cm

MEDO® 30 EL, CADRE DE MONTAGE

MEDO® 40 EL, CADRE DE MONTAGE

MEDO® 60 EL, CADRE DE MONTAGE

PLAFONNIER

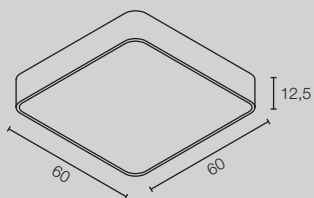

MEDO® 60 CL, CARRÉ

SUSPENSIONS

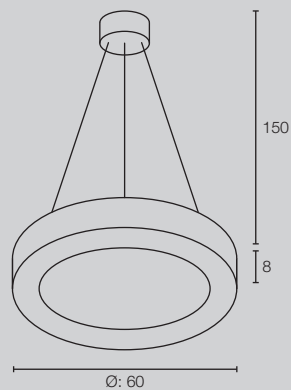

MEDO® RING 60 PD

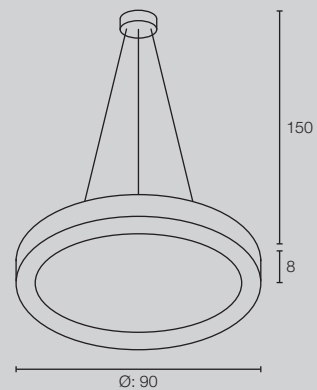

MEDO® RING 90 PD



Tous les plafonniers
peuvent aussi s'utiliser
comme suspensions

APPLIQUES ET PLAFONNIERS

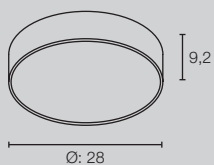

MEDO® PRO 30
CW, DC

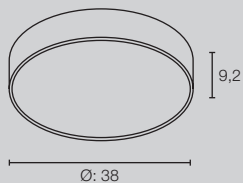

MEDO® PRO 40
CW, DC

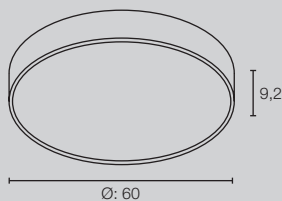

MEDO® PRO 60
CW, DC

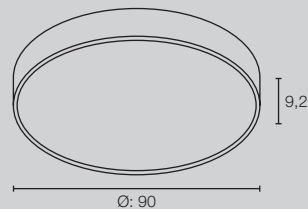

MEDO® PRO 90
CL, DC

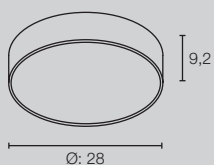

MEDO® PRO 30
CW

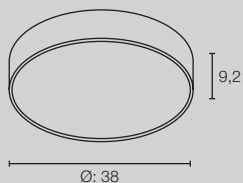

MEDO® PRO 40
CW

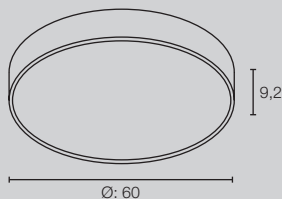

MEDO® PRO 60
CW

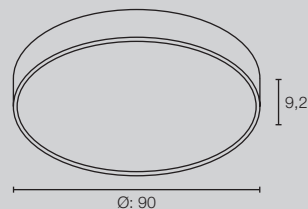

MEDO® PRO 90
CL

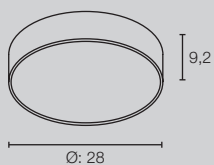

MEDO® 30
CW

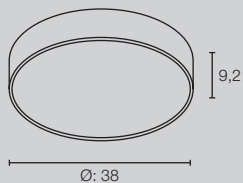

MEDO® 40
CW

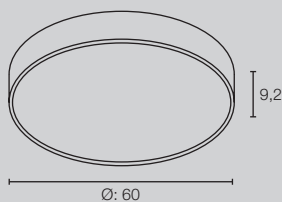

MEDO® 60
CW

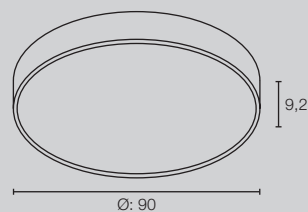

MEDO® 90
CL

LALU®
1007550





LALU®
Suspensions (PD)



Combinez les formes et les couleurs des suspensions LALU®.

LALU®
PD, LED Base, Phase



220-240V ~50/60Hz
Matière : aluminium / acier

			IP20	500mA	9,5W	3000K	680lm

1007518		194.40 CHF
1007519		194.40 CHF
1007520		201.30 CHF



LALU®
PD, LED Base, Phase, Encastré



220-240V ~50/60Hz
Matière : aluminium / acier

			IP20	500mA	9,5W	3000K	680lm

1007548		171.40 CHF
1007549		171.40 CHF
1007550		178.30 CHF



CHOISISSEZ L'ABAT-JOUR ASSORTI



LALU® TETRA 14	noir / bronze antique			1007523	63.30 CHF			
	blanc / or	IP20	Ø : 14 cm, H : 4,9 cm	1007522	63.30 CHF			
	bronze antique			1007521	66.70 CHF			
LALU® TETRA 24	noir / bronze antique			1007526	82.80 CHF			
	blanc / or	IP20	Ø : 24 cm, H : 6,7 cm	1007525	82.80 CHF			
	bronze antique			1007524	89.70 CHF			
LALU® TETRA 36	noir / bronze antique			1007529	131.10 CHF			
	blanc / or	IP20	Ø : 36 cm, H : 8,9 cm	1007528	131.10 CHF			
	bronze antique			1007527	144.90 CHF			
LALU® CONE 15	noir / bronze antique			1007532	65.60 CHF			
	blanc / or	-	Ø : 15,2 cm, H : 17 cm	1007531	65.60 CHF			
	bronze antique			1007530	74.80 CHF			
LALU® ELYPSE 15	noir / bronze antique			1007535	41.40 CHF			
	blanc / or	-	Ø : 15 cm, H : 1,4 cm	1007534	41.40 CHF			
	bronze antique			1007533	48.30 CHF			
LALU® ELYPSE 22	noir / bronze antique			1007538	65.60 CHF			
	blanc / or	-	Ø : 22 cm, H : 2,8 cm	1007537	65.60 CHF			
	bronze antique			1007536	74.80 CHF			
LALU® ELYPSE 33	noir / bronze antique			1007541	102.40 CHF			
	blanc / or	-	Ø : 33 cm, H : 3,5 cm	1007540	102.40 CHF			
	bronze antique			1007539	109.30 CHF			
LALU® PLATE 15	noir / bronze antique			1007544	48.30 CHF			
	blanc / or	-	Ø : 15 cm, H : 1,5 cm	1007543	48.30 CHF			
	bronze antique			1007542	51.80 CHF			
LALU® PLATE 22	noir / bronze antique			1007547	63.30 CHF			
	blanc / or	-	Ø : 22 cm, H : 1,5 cm	1007546	63.30 CHF			
	bronze antique			1007545	67.90 CHF			



MIX & MATCH

LALU®

LALU® TETRA 14

noir | 1007523
blanc | 1007522
bronze antique | 1007521



LALU® CONE 15

noir | 1007532
blanc | 1007531
bronze antique | 1007530

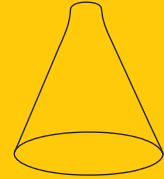

LALU® TETRA 24

noir | 1007526
blanc | 1007525
bronze antique | 1007524



LALU® TETRA 36

noir | 1007529
blanc | 1007528
bronze antique | 1007527



LALU®

PD, LED BASE, PHASE

noir | 1007518
blanc | 1007519
bronze antique | 1007520



LALU®

PD, LED BASE, PHASE, ENCASTRÉ

noir | 1007548
blanc | 1007549
bronze antique | 1007550



LALU® ELYPSE 15

noir | 1007535
blanc | 1007534
bronze antique | 1007533



LALU® PLATE 15

noir | 1007544
blanc | 1007543
bronze antique | 1007542



LALU® ELYPSE 22

noir | 1007538
blanc | 1007537
bronze antique | 1007536



LALU® PLATE 22

noir | 1007547
blanc | 1007546
bronze antique | 1007545



LALU® ELYPSE 33

noir | 1007541
blanc | 1007540
bronze antique | 1007539



LALU®

PD, LED BASE, 48V, DALI

noir | 1007749
blanc | 1007748
bronze antique | 1007747



Combinez les produits de la famille LALU® selon toutes vos envies. Parfaitement assortis, ils vous permettent de combiner formes, tailles et couleurs ou de réaliser une composition à partir de plusieurs luminaires. Laissez parler votre créativité – Vous pouvez identifier les produits SLV Mix & Match à l'aide du symbole suivant :



MIX
match

LALU®
1007653





LALU®
Suspension (PD)

SOCKET
INSIDE



LALU®
PD, E27



IP20

150

220-240V ~50/60Hz
Matière : aluminium

● - IP20 - 10W 1xE27 - 1007658 ● 171.40 CHF



LALU®
Shade, E27 Base

noir / bronze antique

bronze antique

Ø : 33 cm, H : 3,5 cm

1007659 ● 171.40 CHF

1007660 ● 194.40 CHF



A60
180°, CEE = F, 8kWh/1000h



7,5W

2700K

720lm

- 1005305

24.50 CHF

LALU® TAILLES

SUSPENSIONS

MIX
match



LALU® TETRA 14
PD, SHADE

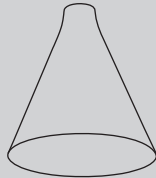

LALU® CONE 15
PD, SHADE



LALU® ELYPSE 15
PD, SHADE



LALU® PLATE 15
PD, SHADE



LALU® TETRA 24
PD, SHADE



LALU® ELYPSE 22
PD, SHADE



LALU® PLATE 22
PD, SHADE

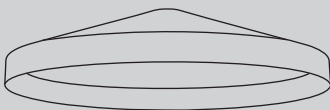

LALU® TETRA 36
PD, SHADE



LALU® ELYPSE 33
PD, SHADE

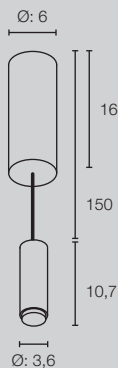

LALU®
PD, LED BASE, PHASE

Dimensions d'encastrement :
Ø : 6,8 cm P : 5 cm

LALU®
PD, LED BASE, PHASE, RECESSED

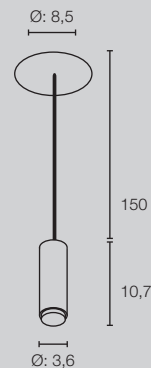

Ø: 3,6

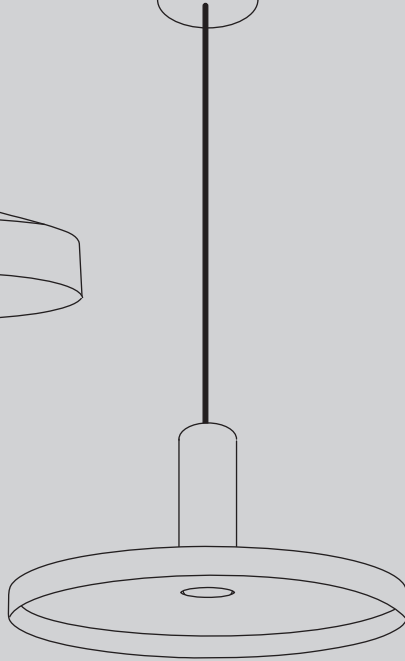
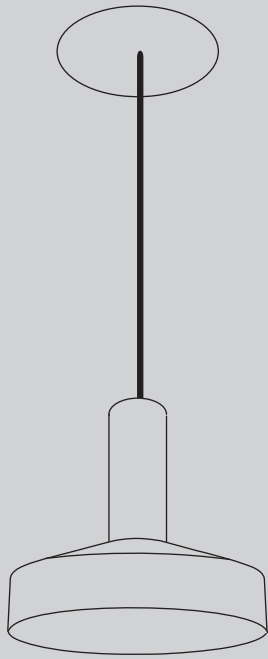

LALU®
PD, SHADE

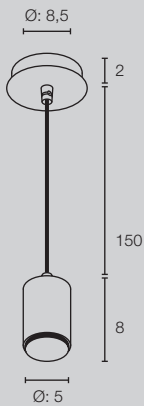

LALU®
PD, E27

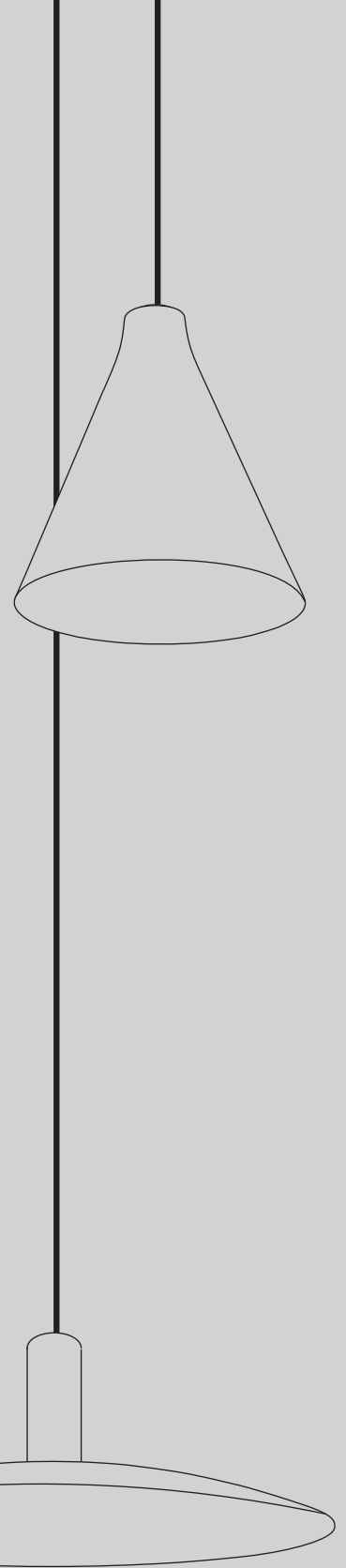

ONE® 60
1005177





ONE®
Suspensions (PD)



ONE® TRIPLE DALI



ONE® 60 DALI



ONE® DOUBLE
PD DALI UP/DOWN



ONE® CUBE
DALI UP/DOWN

ONE® 60 PD, Dali



220-240V ~50/60Hz
Matière : aluminium / acier

		IP20	600mA	24W	CCT 3000 / 4000K	1480 / 1550lm	1002909	509.00 CHF	
	2.0						1002910	509.00 CHF	

ONE® 60 PD, Up/Down, Dali

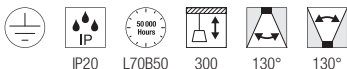

220-240V ~50/60Hz
Matière : aluminium / acier

		IP20	600mA	25W	CCT 3000 / 4000K	400 / 410lm	1004761	599.00 CHF	
	2.0					800 / 820lm	1004762	599.00 CHF	

ONE® 60 PD, Up/Down, Phase



220-240V ~50/60Hz
Matière : aluminium / acier

		IP20	600mA	24W	CCT 2700 / 3000K	410 / 415lm	1004759	549.00 CHF	
							1004760	549.00 CHF	
							1005177	579.00 CHF	

ONE® 80 PD, Dali



220-240V ~50/60Hz
Matière : aluminium / acier

		IP20	800mA	32W	CCT 3000 / 4000K	1930 / 2140lm	1002911	539.00 CHF	
	2.0						1002912	539.00 CHF	

ONE® 80 PD, Up/Down, Dali

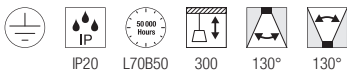

220-240V ~50/60Hz
Matière : aluminium / acier

		IP20	800mA	34W	CCT 3000 / 4000K	615 / 635lm	1004763	699.00 CHF	
	2.0						1004764	699.00 CHF	



ONE® DOUBLE PD, Up/Down, Dali

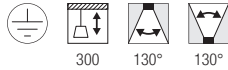

220-240V ~50/60Hz
Matière : aluminium / acier

		-	1400mA	55W	CCT 3000 / 4000K	1050 / 1060lm

1004767	1'299.00 CHF
1004768	1'299.00 CHF



ONE® DOUBLE PD, Up/Down, Phase

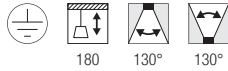

220-240V ~50/60Hz
Matière : aluminium / acier

		-	900mA	35W	CCT 2700 / 3000K	615 / 635lm

1004765	899.00 CHF
1004766	899.00 CHF
1005178	899.00 CHF



ONE® TRIPLE PD, Dali

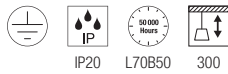

220-240V ~50/60Hz
Matière : aluminium / acier

		IP20	1700mA	64W	CCT 3000 / 4000K	4040 / 4200lm

1002913	1'399.00 CHF
1002914	1'399.00 CHF



ONE® CUBE PD, Dali



220-240V ~50/60Hz
Matière : aluminium / acier

		IP20	1400mA	54W	3000K	4000lm
		IP20	1400mA	54W	4000K	4300lm

1007661	723.40 CHF
1007662	723.40 CHF
1007663	723.40 CHF
1007664	723.40 CHF



ONE® CUBE PD, Up/Down, Dali



220-240V ~50/60Hz
Matière : aluminium / acier

		IP20	2100mA	80W	3000K	UP 2000lm DOWN 4000lm
		IP20	2100mA	80W	4000K	UP 2200lm DOWN 4300lm

1007665	838.40 CHF
1007666	838.40 CHF
1007671	838.40 CHF
1007672	838.40 CHF



ONE® LINEAR 140
1006190





ONE® LINEAR 100

ONE® LINEAR 140

ONE® LINEAR 100 PD, Up/Down, Phase

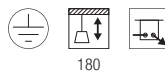

180

220-240V ~50/60Hz
Matière : aluminium / acier



- 600mA 24W CCT 2700 / 3000K

UP 550 / 580lm
DOWN 670 / 700lm

1006185	359.00 CHF
1006186	359.00 CHF
1006187	379.00 CHF



ONE® LINEAR 140 PD, Up/Down, Phase

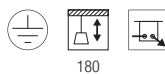

180

220-240V ~50/60Hz
Matière : aluminium / acier



- 900mA 35W CCT 2700 / 3000K

UP 830 / 860lm
DOWN 980 / 1015lm

1006188	449.00 CHF
1006189	449.00 CHF
1006190	399.00 CHF



Retrouvez toutes les dimensions et informations de montage détaillées en pages 200-201

ONE® 60
1002919



ONE® DOUBLE
1004766

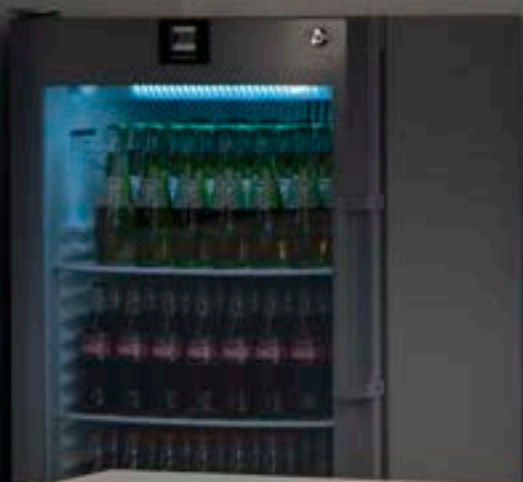
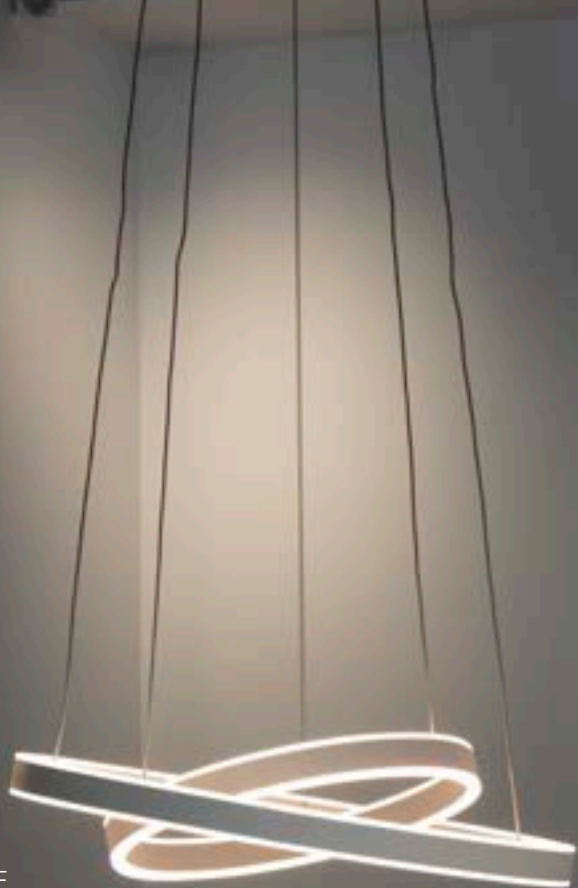



ONE®
Appliques et plafonniers (CW)

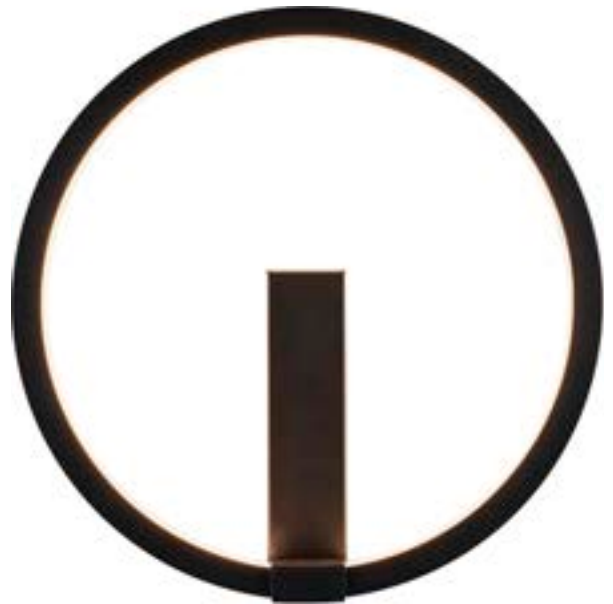

ONE® 40
CW, Dali



220-240V ~50/60Hz
Matière : aluminium / acier

<input checked="" type="radio"/>		IP20	350mA	14W	CCT 3000 / 4000K	700 / 730lm	1002915	399.00 CHF
<input type="radio"/>							1002917	399.00 CHF



ONE® 60
CW, Dali



220-240V ~50/60Hz
Matière : aluminium / acier

<input checked="" type="radio"/>		IP20	600mA	24W	CCT 3000 / 4000K	1350 / 1430lm	1002918	509.00 CHF
<input type="radio"/>							1002919	509.00 CHF



Retrouvez toutes les dimensions et informations de montage détaillées en pages 200-201



ONE® 40 TRACK
1004769

ONE® 40 TRACK
Track 3 all., Dali

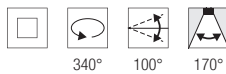

220-240V ~50/60Hz
Matière : aluminium

●	-	350mA	15,2W	3000K	650lm	1004769	379.00 CHF
○						1004770	379.00 CHF
●	-	350mA	15,2W	4000K	670lm	1004771	379.00 CHF
○						1004772	379.00 CHF



Retrouvez toutes les dimensions et informations de montage détaillées en pages 200-201



ONE® 40 TRACK
1004771

ONE® 40 TRACK
Système Track 3 allumages



Orientable à 340° et
inclinable à 100°



ONE®
Lampadaires (FL)



ONE® STRAIGHT
FL, Up/Down

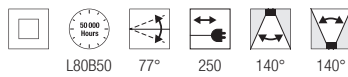

220-240V ~50/60Hz
Matière : acier / polycarbonate (PC)



-

24V

22W

CCT 2700 / 3000K

UP 600 / 600lm
DOWN 600 / 600lm

UGR<22

- 1006355 ● 999.00 CHF
- 1006354 ● 999.00 CHF
- 1006353 ● 999.00 CHF





 Flux lumineux des anneaux contrôlable séparément

NEW

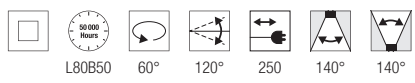
ONE® BOW
FL, Up/Down

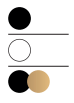

220-240V ~50/60Hz
Matière : acier / polycarbonate (PC)



-

24V

22W

CCT 2700 / 3000K

UP 600 / 600lm
DOWN 600 / 600lm

UGR<22

- 1006352 ● 1'499.00 CHF
- 1006351 ● 1'499.00 CHF
- 1006350 ● 1'499.00 CHF

Retrouvez toutes les dimensions et informations de montage détaillées en pages 200-201



ONE® STRAIGHT
1006353



ONE® BOW
1006351

ONE® TAILLES

SUSPENSIONS

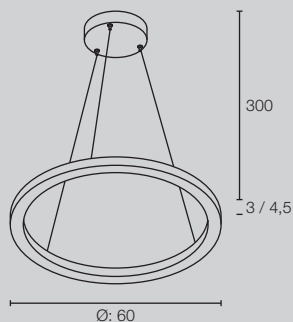

ONE® 60 / **ONE® 60**
PD, DALI / PD, UP/DOWN, DALI

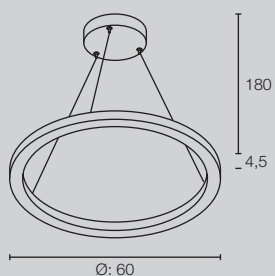

ONE® 60
PD, UP/DOWN, PHASE

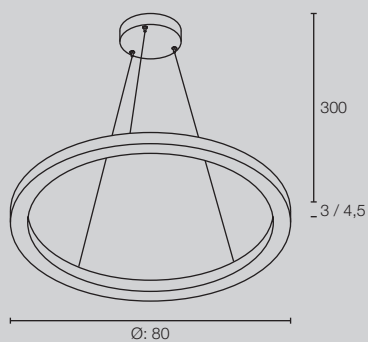

ONE® 80 / **ONE® 80**
PD, DALI / PD, UP/DOWN, DALI

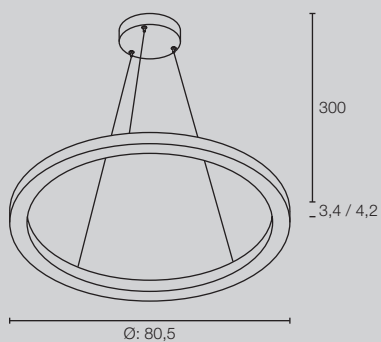

ONE® CUBE / **ONE® CUBE**
PD, DALI / PD, UP/DOWN, DALI

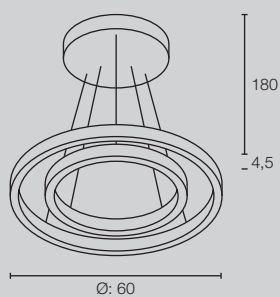

ONE® DOUBLE 60
PD, UP/DOWN, DALI

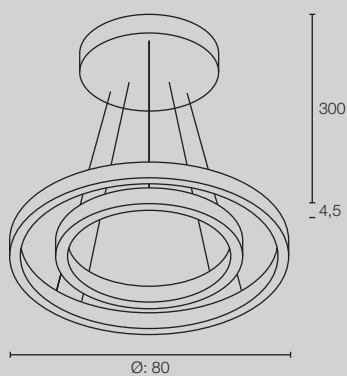

ONE® DOUBLE 80
PD, UP/DOWN, DALI

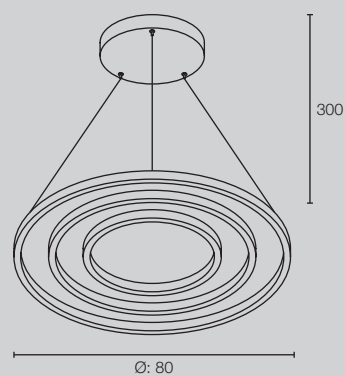

ONE® TRIPLE
PD, DALI

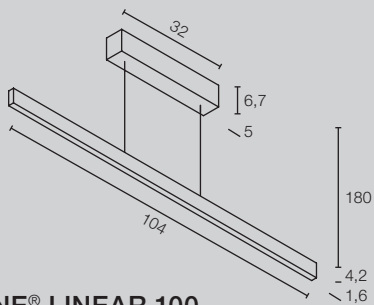

ONE® LINEAR 100
PD, UP/DOWN, DALI

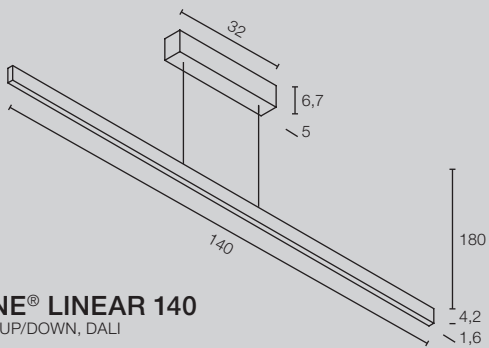

ONE® LINEAR 140
PD, UP/DOWN, DALI

APPLIQUES

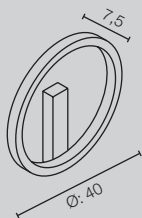

ONE® 40
CW, DALI

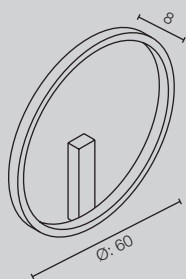

ONE® 60
CW, DALI

SYSTÈME TRACK

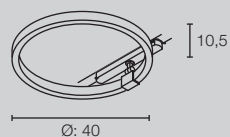

ONE® 40 TRACK
TRACK 3PH, DALI

LAMPADAIRES



ONE® STRAIGHT
FL, UP/DOWN, SWITCH

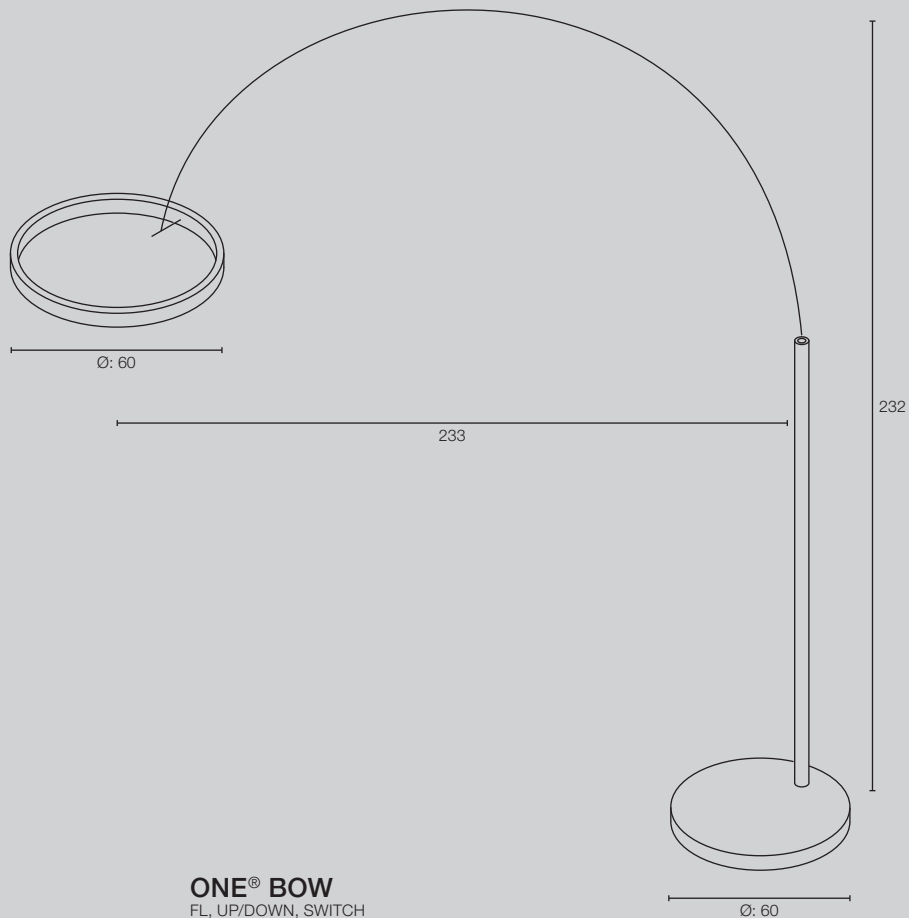

ONE® BOW
FL, UP/DOWN, SWITCH



Retrouvez les **NUMINOS®** dans les pages familles 82–93

LED

NEW



Retrouvez les **NEW TRIA®** dans les pages familles 122–147

LED



Retrouvez les **MEDO®** dans les pages familles 168–171

LED

NEW



LED

UNIVERSAL DOWNLIGHT | 205

NEW



LED

UNIVERSAL DOWNLIGHT | 207

NEW



LED

UNIVERSAL DOWNLIGHT | 208

NEW



LED

UNIVERSAL DOWNLIGHT | 209

NEW



LED

KADUX | 213

NEW



LED

KADUX | 213

NEW



LED

KADUX | 213



SCKET

KADUX | 214



SCKET

KADUX | 214



SCKET

KADUX | 214



SCKET

KADUX | 215



SCKET

KADUX | 215



LED

MILANDOS 4 | 217



LED

MILANDOS 6 | 217



LED

MILANDOS 8 | 217



LED

HORN MINI | 218



SCKET

HORN | 219



SCKET

HORN | 219



SCKET

HORN | 219



SCKET

HORN | 220



SCKET

HORN | 220



SCKET

HORN | 220



SCKET

HORN-T | 221



LED

HORN MAGNA | 221



LED

SENER 12 | 223



LED

SENER 18 | 223



LED

SENER 24 | 223



LED

SENER 12 | 225



LED

SENER 18 | 225



LED

SENER 24 | 225



LED

VERLUX | 227



LED

VERLUX | 227



LED

DL 126 | 227



SCKET

PIKA | 228



SCKET

PIKA | 228



LED

OCULUS | 229



LED
OCCULDAS 14 | 230



LED
OCCULDAS 23 | 230



LED
CONTONE® | 231



LED
CONTONE® | 231



LED
H-LIGHT | 232



LED
KARPO 30 | 232



SCKET
PLASTRA | 233



SCKET
PLASTRA | 233



LED
DEKLED | 234



SCKET
VARU | 234



SCKET
DOLIX OUT | 235



SCKET
DOLIX OUT | 235



LED
KAMUELA ECO | 236



LED
KAMUELA ECO | 237



LED
KINI | 237



LED
AKALO D83 | 237



LED
FRAME BASIC
SET | 238



LED
FRAME BASIC | 238



LED
FRAME BASIC | 238



LED
FRAME CURVE | 239



LED
FRAME CURVE | 239



LED
QUAD FRAME 9 | 240



LED
NOTAPO S | 241



LED
NOTAPO L | 241



LED
DOWNUNDER
PUR 80 | 242



LED
DOWNUNDER
PUR 150 | 242



LED
MOBALA | 243



LED
WORO | 243



LED
LED PANEL | 243



LED
PATTA-I | 244



LED
PATTA-I | 244



LED
PATTA-I | 245



LED
PATTA-I | 245



LED
PATTA-F | 246



LED
PATTA-F | 247

1007095 + 1007180 205

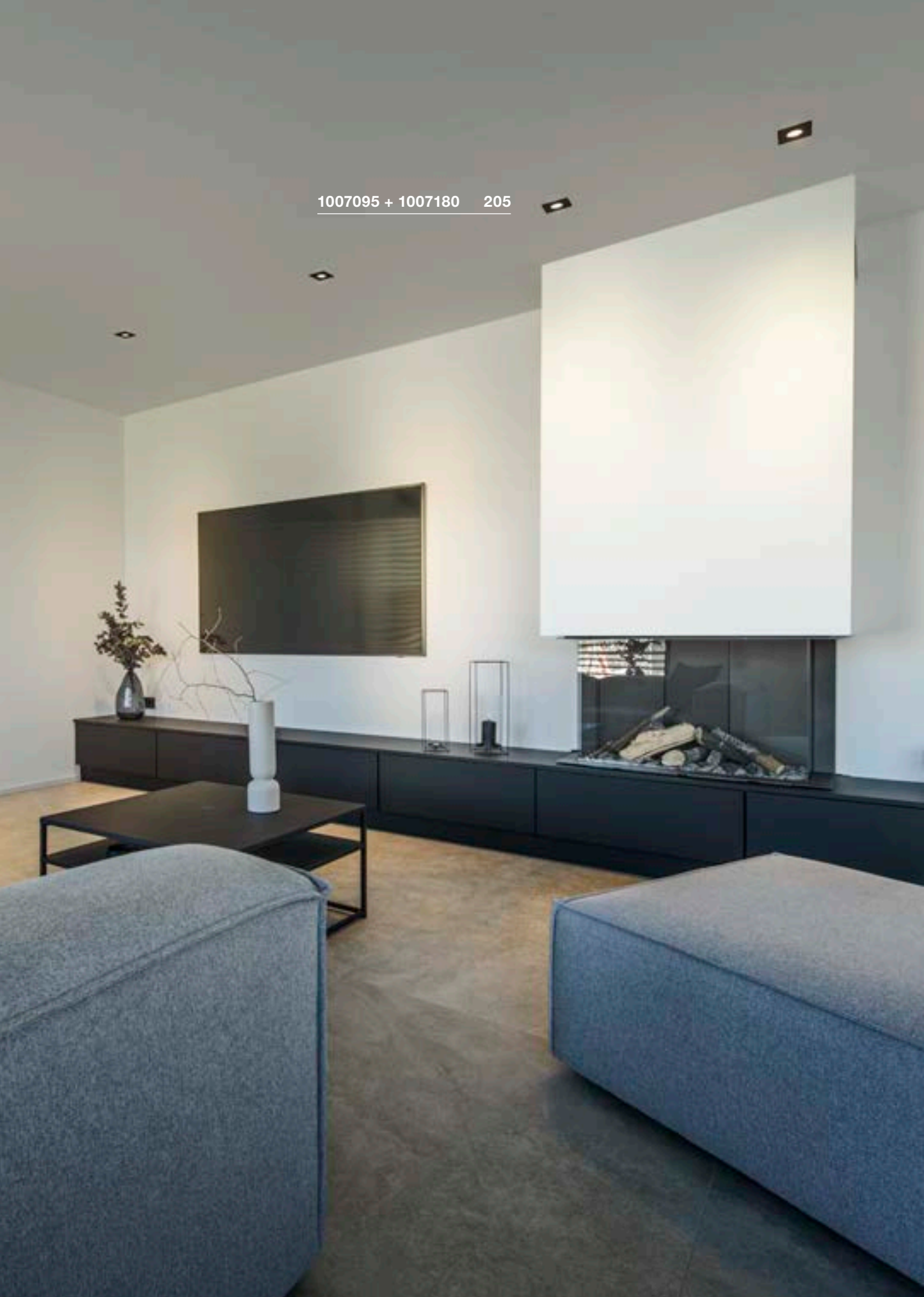



UNIVERSAL DOWNLIGHT Cover, collerette, ronde



Ø : 8,8 cm
H : 0,35 cm
Matière : polycarbonate (PC)

Variante	Réf.	CHF
● noir	1007096	3.90
○ blanc	1007097	3.90
● or brillant	1007099	4.50
● or mat	1007192	4.50
● alu brossé	1007098	4.50

UNIVERSAL DOWNLIGHT DL, PHASE

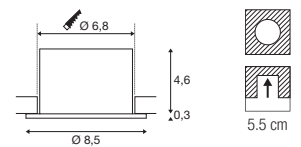

UNIVERSAL DOWNLIGHT Cover, collerette, carrée



L : 8,8 cm
l : 8,8 cm
H : 0,35 cm
Matière : polycarbonate (PC)

Variante	Réf.	CHF
● noir	1007180	5.20
○ blanc	1007181	5.20
● or brillant	1007183	5.90
● or mat	1007193	5.90
● alu brossé	1007182	5.90



220-240V ~50/60Hz | 60/90mA
Puissance totale : 5W/8W
Matière : acier

- Encastré fixe
- Épaisseur du support de montage : 25 mm max.



5W	410lm	2700K
	430lm	3000K
	470lm	4000K
	440lm	6500K
8W	560lm	2700K
	610lm	3000K
	680lm	4000K
	640lm	6500K

Variante	Réf.	CHF
● noir	1007095	32.90

1007090 + 1007184 205



WATCH OUT
MONSTER INSIDE



1002



UNIVERSAL DOWNLIGHT Cover, collerette, ronde



Ø : 8,8 cm
H : 0,35 cm
Matière : polycarbonate (PC)

Variante	Réf.	CHF
● noir	1007091	3.90
○ blanc	1007092	3.90
● or brillant	1007094	4.50
● or mat	1007191	4.50
● alu brossé	1007093	4.50

UNIVERSAL DOWNLIGHT DL, Move, PHASE

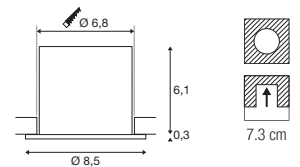

UNIVERSAL DOWNLIGHT Cover, collerette, carrée



L : 8,8 cm
l : 8,8 cm
H : 0,35 cm
Matière : polycarbonate (PC)

Variante	Réf.	CHF
● noir	1007184	5.20
○ blanc	1007185	5.20
● or brillant	1007187	5.90
● or mat	1007194	5.90
● alu brossé	1007186	5.90

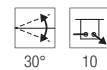

220-240V ~50/60Hz | 60/90mA
Puissance totale : 5W/8W
Matière : acier

- Encastré orientable
- Épaisseur du support de montage : 25 mm max.



5W	410lm	2700K
	610lm	3000K
	680lm	4000K
	640lm	6500K
8W	560lm	2700K
	610lm	3000K
	680lm	4000K
	640lm	6500K

Variante	Réf.	CHF
● noir	1007090	32.90

UNIVERSAL DOWNLIGHT DL with Cover, Multipack

1007271 208

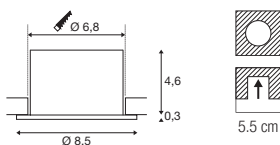

220-240V ~50/60Hz | 60/90mA
Puissance totale : 5W/8W
Matière : acier

- Kit de 12 encastrés fixes avec collerettes
- Épaisseur du support de montage : 25 mm max.



5W	560lm	2700K
	610lm	3000K
	680lm	4000K
	640lm	6500K
8W	560lm	2700K
	610lm	3000K
	680lm	4000K
	640lm	6500K

Variante	Réf.	CHF
● noir	1007271	407.10
○ blanc	1007272	407.10

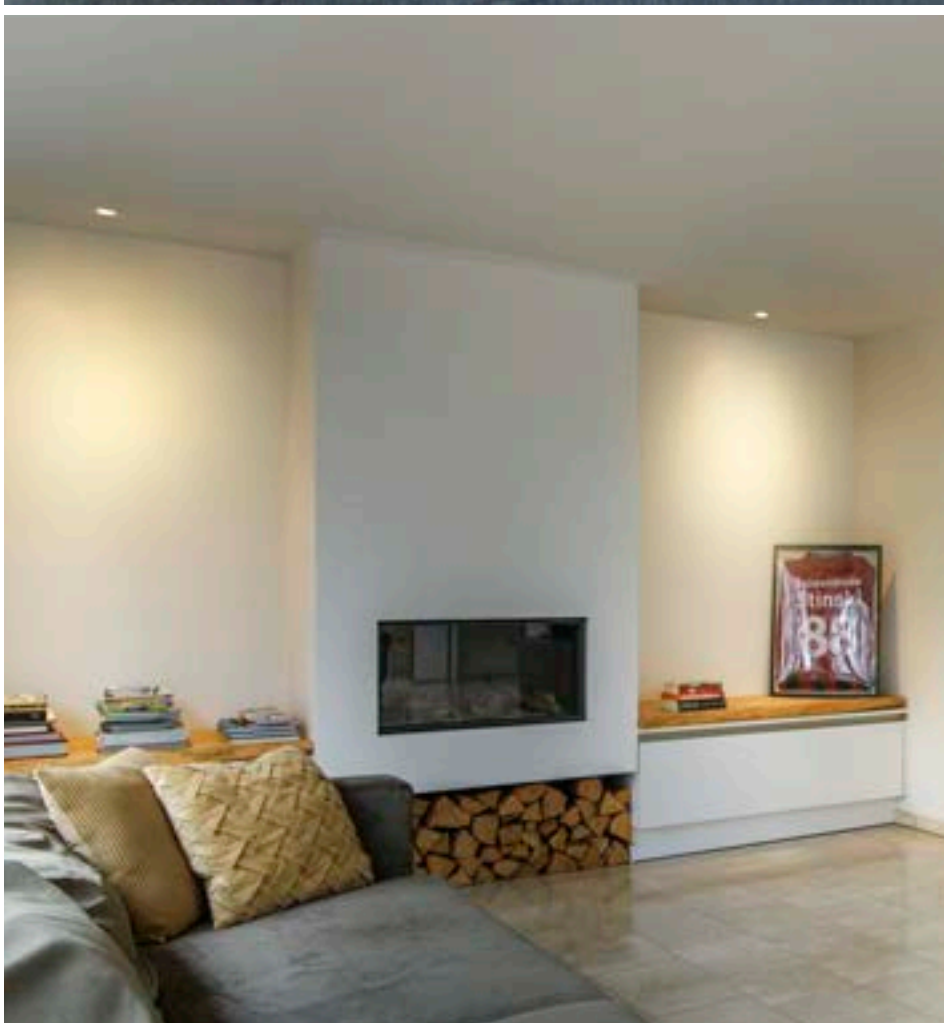
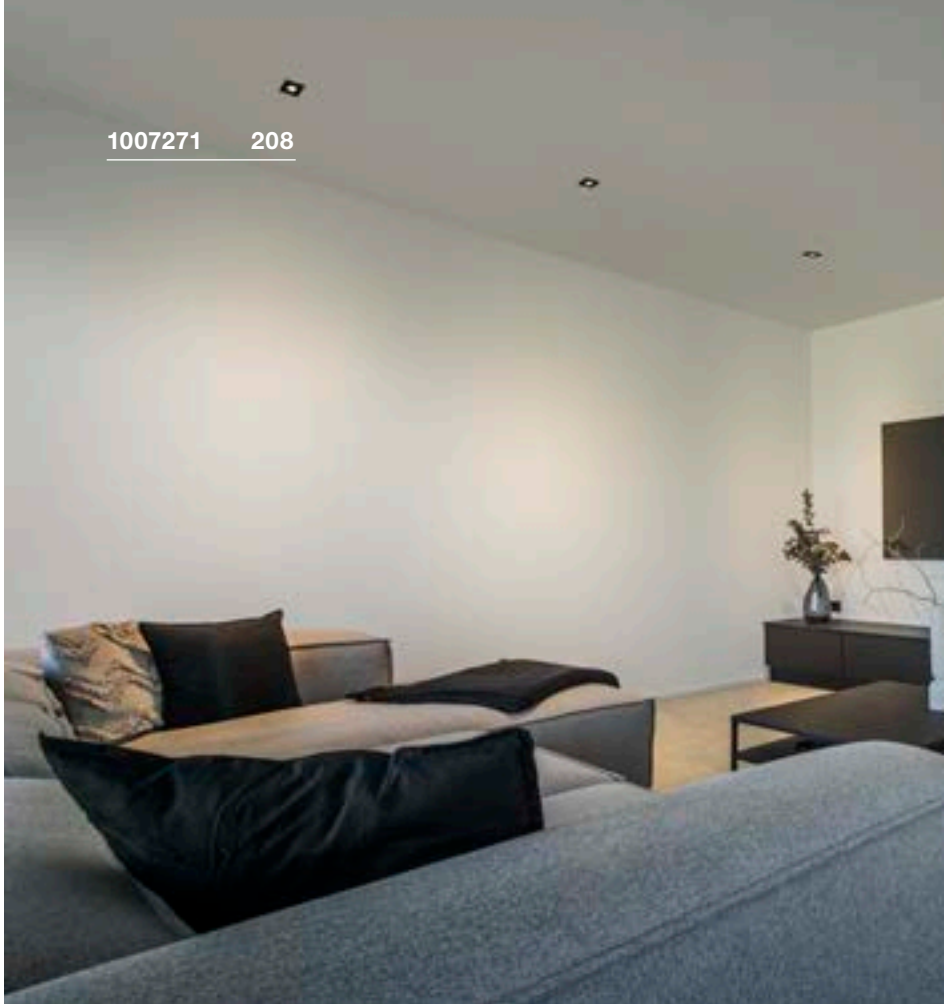



UNIVERSAL DOWNLIGHT DL with Cover, Multipack



NEW

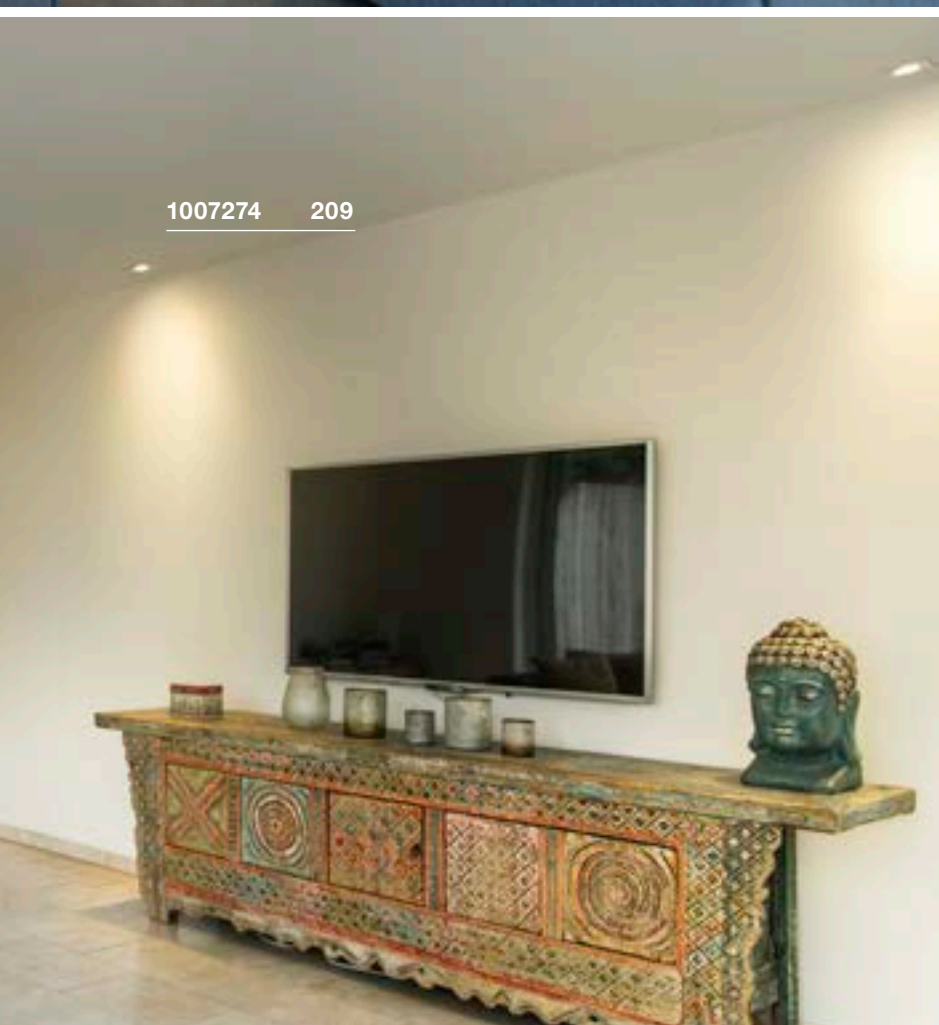
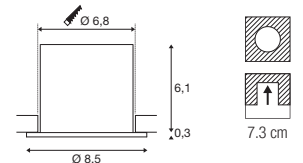

1007274 209

220-240V ~50/60Hz | 60/90mA
 Puissance totale : 5W/8W
 Matière : acier

- Kit de 12 encastrés orientables avec collerettes
- Épaisseur du support de montage : 25 mm max.



5W	410lm	2700K
	610lm	3000K
	680lm	4000K
	640lm	6500K
8W	560lm	2700K
	610lm	3000K
	680lm	4000K
	640lm	6500K

Variante	Réf.	CHF
● noir	1007273	414.00
○ blanc	1007274	414.00

CRÉEZ VOTRE DOWNLIGHT

Discret et universel : les UNIVERSAL DOWNLIGHTS en version fixe et orientable sont des luminaires encastrés qui produisent une lumière ciblée grâce à leur angle de rayonnement étroit de 38 degrés. Avant l'installation, la température de couleur peut être sélectionnée via le CCT-Switch (2700/3000/4000/6500K). Un rendu des couleurs fidèle à la réalité est obtenu avec un IRC supérieur à 90. Grâce au boîtier Quick Connector, le downlight s'installe rapidement et facilement. Complétez votre UNIVERSAL DOWNLIGHT avec les collerettes décoratives vendues séparément, disponibles en noir, blanc, alu brossé, or brillant ou or mat.

SÉLECTIONNEZ VOS OPTIONS ...

- 1 Version (fixe, orientable)
- 2 Collerette décorative (noir, blanc, alu brossé, or brillant, or mat)
- 3 Température de couleur (2700K, 3000K, 4000K, 6500K)
- 4 Puissance totale (5W, 8W)



LE TOUR EST JOUÉ !

UNIVERSAL DOWNLIGHT

UNIVERSAL DOWNLIGHT



Disponible en version fixe en forme ronde ou carrée

UNIVERSAL DOWNLIGHT MOVE



Disponible en version orientable en forme ronde ou carrée

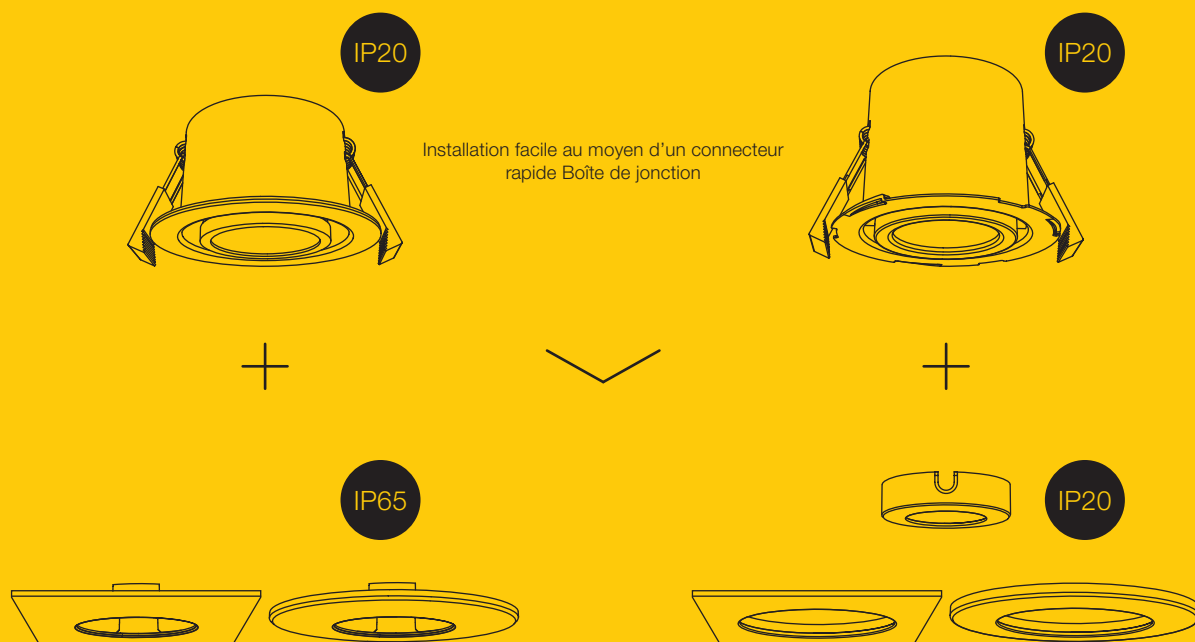

IP20

Installation facile au moyen d'un connecteur rapide Boîte de jonction

IP20

IP65

IP20

Collerettes décoratives interchangeables carrées ou rondes disponibles en coloris noir, blanc, alu brossé, or brillant et or mat

2700K 3000K 4000K 6500K Température de couleur commutable 2700K 3000K 4000K 6500K

Puissance du système commutable
5W / 8W

Qualité de lumière et rendu des couleurs élevés grâce aux LED avec IRC>90

1007560 213



1007567 213



1007551 213

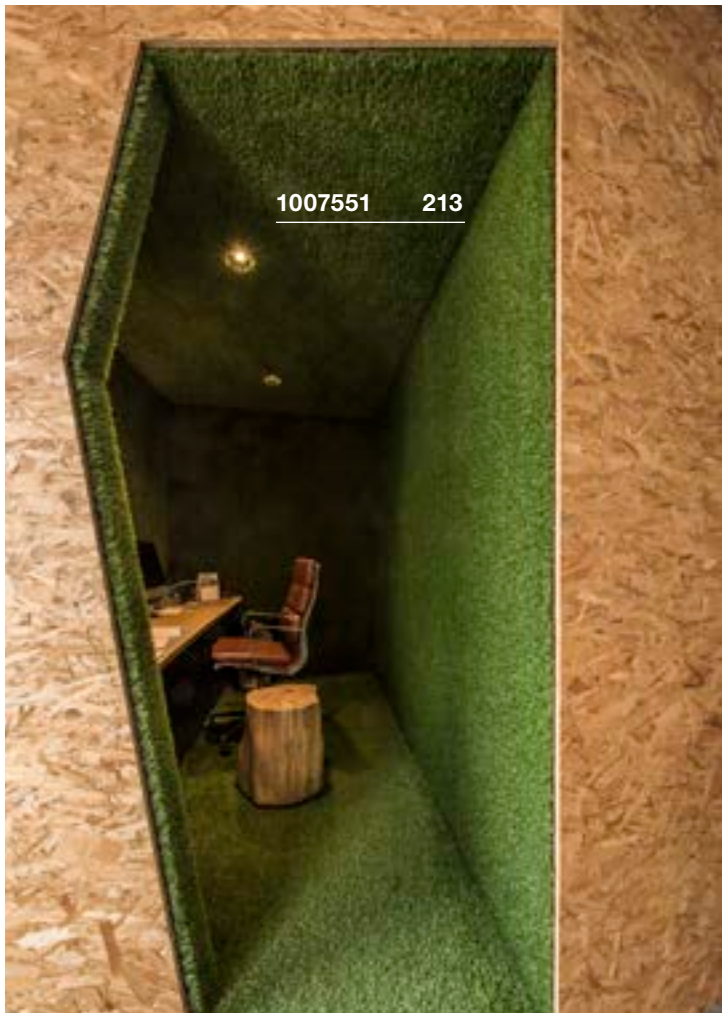



KADUX DL, simple, PHASE

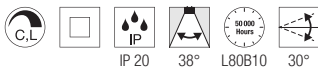
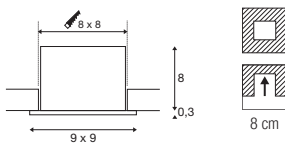

220-240V ~50/60Hz | 350mA
Puissance totale : 7,5W
Matière : aluminium / acier

- Clips ressorts
- Épaisseur du support de montage : 30 mm max.



Down 770lm | 3000K

Variante	Réf.	CHF
● noir	1007551	97.80
○ blanc	1007552	97.80

KADUX DL, double, PHASE

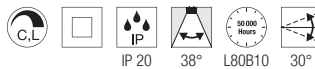
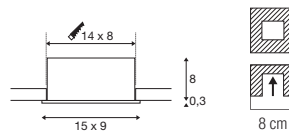

220-240V ~50/60Hz | 350mA
Puissance totale : 14W
Matière : aluminium / acier

- Clips ressorts
- Épaisseur du support de montage : 30 mm max.



Down 1510lm | 3000K

Variante	Réf.	CHF
● noir	1007559	184.00
○ blanc	1007560	184.00

KADUX DL, triple, PHASE

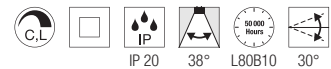
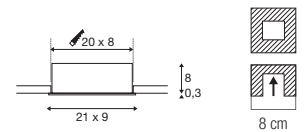

220-240V ~50/60Hz | 350mA
Puissance totale : 20W
Matière : aluminium / acier

- Clips ressorts
- Épaisseur du support de montage : 30 mm max.



Down 2310lm | 3000K

Variante	Réf.	CHF
● noir	1007567	242.70
○ blanc	1007568	242.70

KADUX
EL, simple, QPAR51

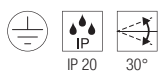
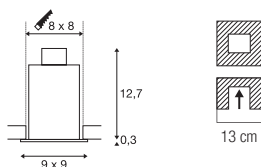

220-240V ~50/60Hz
Matière : aluminium / acier

- Clips ressorts
- Épaisseur du support de montage : 30 mm max.



Douille : 1xGU10

Variante	Réf.	CHF
● noir	115510	41.60
○ blanc	115511	41.60

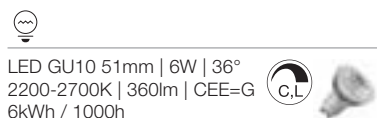

Réf. : 1005273 | 12.90 CHF

KADUX
EL, double, QPAR51

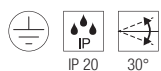
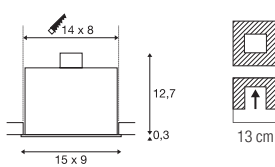

220-240V ~50/60Hz
Matière : aluminium / acier

- Clips ressorts
- Épaisseur du support de montage : 30 mm max.



Douilles : 2xGU10

Variante	Réf.	CHF
● noir	115520	74.00
○ blanc	115521	74.00



Réf. : 1005273 | 12.90 CHF

KADUX
EL, triple, QPAR51

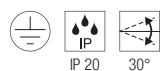
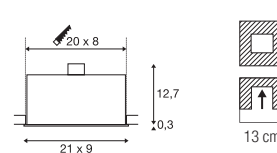

220-240V ~50/60Hz
Matière : aluminium / acier

- Clips ressorts
- Épaisseur du support de montage : 30 mm max.



Douilles : 3xGU10

Variante	Réf.	CHF
● noir	115530	106.00
○ blanc	115531	106.00

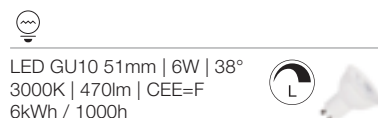

Réf. : 1005079 | 10.60 CHF



115550

215

KADUX
EL, simple, QPAR111

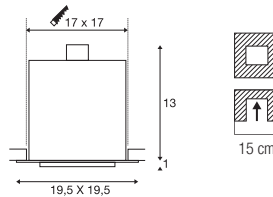

KADUX
EL, double, QPAR111

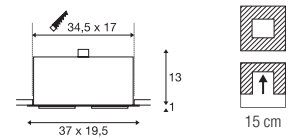

115531

214

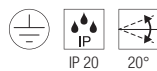

220-240V ~50/60Hz
Matière : aluminium / acier

- Clips ressorts
- Épaisseur du support de montage : 25 mm max.



Douille : 1xGU10

Variante	Réf.	CHF
● noir	115540	125.00
○ blanc	115541	125.00



QPAR111 | 8W | 38°
2700K | 680lm | CEE=F
8kWh / 1000h

Réf. : 1005274 | 35.20 CHF

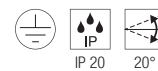

220-240V ~50/60Hz
Matière : aluminium / acier

- Clips ressorts
- Épaisseur du support de montage : 25 mm max.



Douilles : 2xGU10

Variante	Réf.	CHF
● noir	115550	202.00
○ blanc	115551	202.00



QPAR111 | 8W | 38°
2700K | 680lm | CEE=F
8kWh / 1000h

Réf. : 1005274 | 35.20 CHF







MILANDOS 4 DL

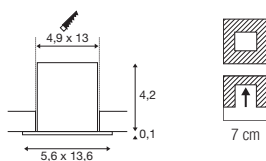

700mA
Puissance totale : 8W
Matière : aluminium / polycarbonate (PC)

- Clips ressorts
- Épaisseur du support de montage : 40 mm max.



Down	510lm 2700K 520lm 3000K 650lm 3000K
------	---

Variante	Réf.	CHF
● noir 510lm 2700K	1005407	219.00
● noir 520lm 3000K	1005408	219.00
○ blanc 650lm 3000K	1005410	219.00



Article	Réf.	CHF
Driver LED 20W 250-700mA variable 1-10V/ DALI, avec serre-câble		
○ blanc	1002423	117.00
Driver LED 10W 700mA variable avec serre-câble		
○ blanc	1007213	40.30

MILANDOS 6 DL

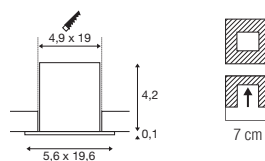

700mA
Puissance totale : 12W
Matière : aluminium / polycarbonate (PC)

- Clips ressorts
- Épaisseur du support de montage : 40 mm max.



Down	770lm 2700K 780lm 3000K 980lm 3000K
------	---

Variante	Réf.	CHF
● noir 770lm 2700K	1005415	235.00
● noir 780lm 3000K	1005416	235.00
○ blanc 980lm 3000K	1005418	235.00



Article	Réf.	CHF
Driver LED 15W 700mA avec serre-câble		
○ blanc	1006202	42.90
Driver LED 20W 700mA variable, avec serre-câble		
○ blanc	1002423	117.00

MILANDOS 8 DL

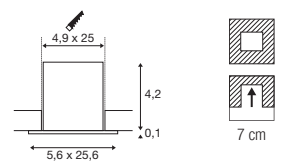

700mA
Puissance totale : 16W
Matière : aluminium / polycarbonate (PC)

- Clips ressorts
- Épaisseur du support de montage : 40 mm max.



Down	1030lm 2700K 1040lm 3000K
------	----------------------------------

Variante	Réf.	CHF
● noir 1030lm 2700K	1005423	289.00
● noir 1040lm 3000K	1005424	289.00



Article	Réf.	CHF
Driver LED 20W 250-700mA variable 1-10V/ DALI, avec serre-câble		
○ blanc	1002423	117.00
Driver LED 20W 700mA variable avec serre-câble		
○ blanc	1006202	42.90

HORN MINI EL

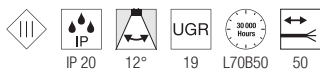
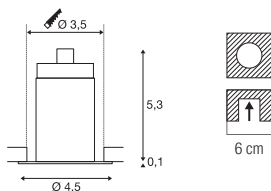

350mA
Puissance consommée : 1W
Matière : aluminium / polycarbonate (PC)

- Clips ressorts
- Fiche AMP fournie
- Lumière chaleureuse grâce au réflecteur doré
- Driver non fourni



Down 70lm | 2900K
3000K

Variante	Réf.	CHF
● noir 3000 K	1000915	48.00
● noir / or 2900 K	1000917	49.10
○ blanc 3000 K	1000914	48.00



Article	Réf.	CHF
Câble d'extension 1 m		
○ blanc	111861	10.60
Driver LED 3W 350 mA, avec fiche AMP		
○ blanc	1007270	22.80
Fiche de connexion 3 sorties		
● noir	111850	17.00

113141 219



1000914 218





HORN
DL, simple, QPAR51

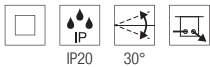
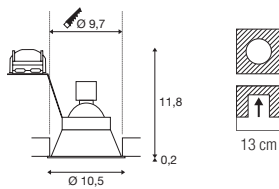

220-240V ~50/60Hz
Matière : aluminium

- Clips ressorts
- Épaisseur du support de montage : 30 mm max.



Douille : 1xGU10

Variante	Réf.	CHF
● noir	113140	64.00
○ blanc	113141	64.00



LED GU10 51mm | 6W | 38°
2700K | 450lm | CEE=F
6kWh / 1000h



Réf. : 1005077 | 10.60 CHF

HORN
DL, double, QPAR51

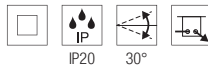
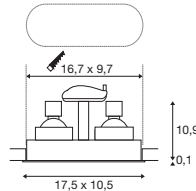

220-240V ~50/60Hz
Matière : aluminium

- Clips ressorts
- Épaisseur du support de montage : 30 mm max.



Douilles : 2xGU10

Variante	Réf.	CHF
● noir	1006121	79.00
○ blanc	1006122	79.00



LED GU10 51mm | 6W | 38°
2700K | 450lm | CEE=F
6kWh / 1000h



Réf. : 1005077 | 10.60 CHF

HORN
DL, simple, asymétrique, QPAR51

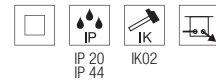
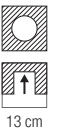
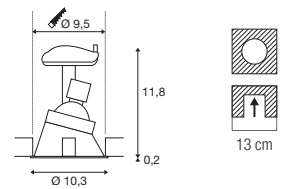

220-240V ~50/60Hz
Matière : aluminium

- Clips ressorts
- Épaisseur du support de montage : 30 mm max.



Douille : 1xGU10

Variante	Réf.	CHF
● noir	113150	70.00
○ blanc	113151	70.00



LED GU10 51mm | 6W | 36°
2200-2700K | 360lm | CEE=G
6kWh / 1000h



Réf. : 1005273 | 12.90 CHF

HORN
DL, simple, QPAR51

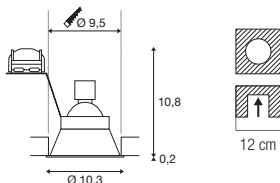

220-240V ~50/60Hz
Matière : aluminium

- Clips ressorts
- Épaisseur du support de montage : 25 mm max.



Douille : 1xGU10

Variante	Réf.	CHF
● noir	113160	64.00
○ blanc	113161	64.00

LED GU10 51mm | 6W | 38°
2700K | 450lm | CEE=F
6kWh / 1000h

Réf. : 1005077 | 10.60 CHF

HORN
EL, simple, QPAR51

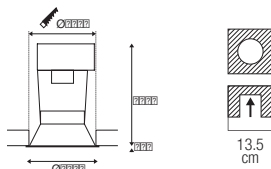

220-240V ~50/60Hz
Matière : acier

- Clips ressorts
- Épaisseur du support de montage : 45 mm max.



Douille : 1xGU10 Ø max. : 5,1 cm L : 5,4 cm

Variante	Réf.	CHF
● noir	112910	33.00
○ blanc	112911	33.00

LED GU10 51mm | 6W | 38°
2700K | 450lm | CEE=F
6kWh / 1000h

Réf. : 1005077 | 10.60 CHF

HORN
DL, GU10, étanchéité à l'air testée

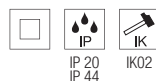
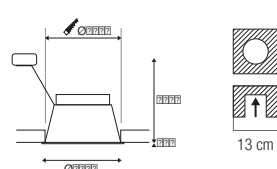

220-240V ~50/60Hz
Matière : aluminium

- Le downlight répond aux exigences de la RT2012.
- Épaisseur du support de montage : 30 mm max.



Douille : 1xGU10

Variante	Réf.	CHF
● noir	1005435	33.00
○ blanc	1005436	33.00

LED GU10 51mm | 6W | 38°
2700K | 450lm | CEE=F
6kWh / 1000h

Réf. : 1005077 | 10.60 CHF



112911 220

HORN-T EL, QPAR111

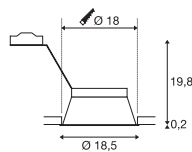

HORN MAGNA EL

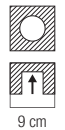
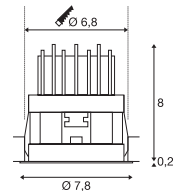

1002592 221



220-240V ~50/60Hz
Matière : acier

- Clips ressorts
- Épaisseur du support de montage : 30 mm max.



Douille : 1xGU10

Variante	Réf.	CHF
● noir	113170	85.00
○ blanc	113171	85.00



QPAR111 | 8W | 38°
2700K | 680lm | CEE=F
8kWh / 1000h



Réf. : 1005274 | 35.20 CHF

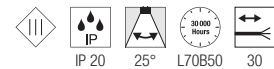

500mA
Puissance totale : 9W
Matière : aluminium / polycarbonate (PC)

- Lumière chaleureuse grâce au réflecteur doré
- Clips ressorts
- Épaisseur du support de montage : 25 mm max.
- Câble nu



Down 445lm | 550lm | 570lm | 3000K

Variante	Réf.	CHF
● noir		
● noir / or	1002592	99.00
● 570lm	1002594	99.00
○ blanc		
○ 550lm	1002591	99.00



Article	Réf.	CHF
Driver LED 20W 350 mA/500mA PHASE		
○ blanc	1007227	46.00
Driver LED 25W 150-700mA variable DALI		
○ blanc	1007229	80.50
Driver LED 21W 500 mA, avec serre-câble		
○ blanc	1007226	34.50

1003010 223





SENSE 12 EL, rond

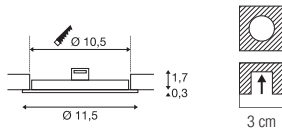

200mA
Puissance totale : 6,4W
Matière : aluminium

- Clips ressorts
- Épaisseur du support de montage : 15 mm max.



Down 420lm | 3000K
470lm | 4000K

Variante	Réf.	CHF
○ blanc 420lm 3000K 6.4W	1003008	33.00
○ blanc 470lm 4000K 6W	1004694	38.40



Article	Réf.	CHF
Driver LED 25W 150-700mA variable DALI ○ blanc	1007229	80.50
Driver LED 10W 200mA variable, avec serre-câble ○ blanc	1007215	40.30

SENSE 18 EL, rond

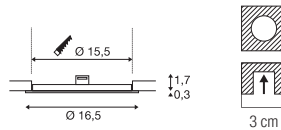

350mA
Puissance totale : 10W
Matière : aluminium

- Clips ressorts
- Épaisseur du support de montage : 15 mm max.



Down 880lm | 3000K
990lm | 4000K

Variante	Réf.	CHF
○ blanc 880lm 3000K 10W	1003009	41.60
○ blanc 990lm 4000K 12W	1004695	45.90



Article	Réf.	CHF
Driver LED 20W 350mA variable ○ blanc	1007228	46.00
Driver LED 25W 150-700mA variable DALI ○ blanc	1007229	80.50

SENSE 24 EL, rond

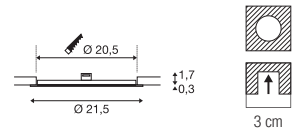

500mA
Puissance totale : 13W
Matière : aluminium

- Clips ressorts
- Épaisseur du support de montage : 15 mm max.



Down 1200lm | 3000K
1300lm | 4000K

Variante	Réf.	CHF
○ blanc 1200lm 3000K	1003010	55.00
○ blanc 1300lm 4000K	1004696	55.00



Article	Réf.	CHF
Driver LED 20W 350 mA/500mA PHASE ○ blanc	1007227	46.00
Driver LED 25W 150-700mA variable DALI ○ blanc	1007229	80.50
Driver LED 21W 500 mA, avec serre-câble ○ blanc	1007226	34.50

1003011 225





SENDER 12 EL, carré

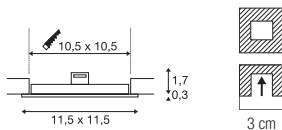

200mA
Puissance totale : 6,4W
Matière : aluminium

- Clips ressorts
- Épaisseur du support de montage : 15 mm max.



Down 440lm | 3000K | 4000K

Variante	Réf.	CHF
○ blanc 3000K	1003011	33.00
○ blanc 4000K	1004697	38.40



Article	Réf.	CHF
Driver LED 25W 150-700mA variable DALI ○ blanc	1007229	80.50
Driver LED 10W 200mA variable, avec serre-câble ○ blanc	1007215	40.30

SENDER 18 EL, carré

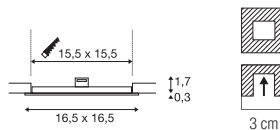

350mA
Puissance totale : 10W
Matière : aluminium

- Clips ressorts
- Épaisseur du support de montage : 15 mm max.



Down 880lm | 900lm | 4000K | 3000K

Variante	Réf.	CHF
○ blanc 900lm 3000K 10W	1003012	41.60
○ blanc 880lm 4000K 12W	1004698	45.90



Article	Réf.	CHF
Driver LED 20W 350mA variable ○ blanc	1007228	46.00
Driver LED 25W 150-700mA variable DALI ○ blanc	1007229	80.50

SENDER 24 EL, carré

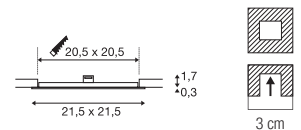

500mA
Puissance totale : 13W
Matière : aluminium

- Clips ressorts
- Épaisseur du support de montage : 15 mm max.



Down 1100lm | 1240lm | 3000K | 4000K

Variante	Réf.	CHF
○ blanc 1100lm 3000K	1003013	55.00
○ blanc 1240lm 4000K	1004699	55.00



Article	Réf.	CHF
Driver LED 20W 350 mA/500mA PHASE ○ blanc	1007227	46.00
Driver LED 25W 150-700mA variable DALI ○ blanc	1007229	80.50
Driver LED 21W 500 mA, avec serre-câble ○ blanc	1007226	34.50

112682 227



112222 227



112225 227

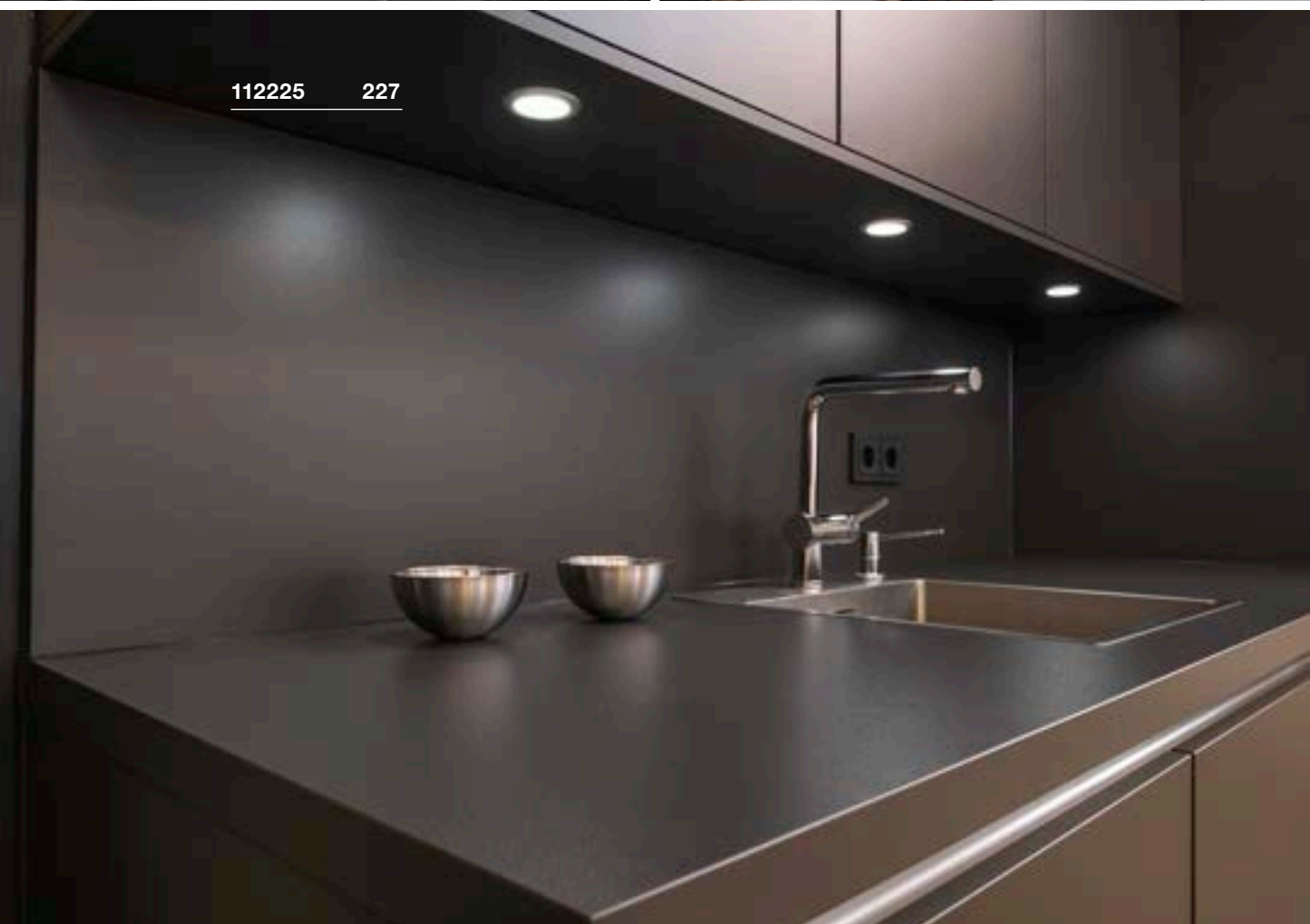



VERLUX
EL, carré, PHASE

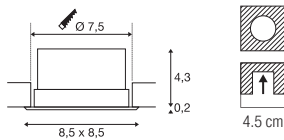

220-240V ~50/60Hz | 500mA
Puissance totale : 11W
Matière : aluminium / plastique

- Clips ressorts
- Épaisseur du support de montage : 20 mm max.



Down 940lm | 3000K

Variante	Réf.	CHF
○ blanc	112682	109.00

VERLUX
EL, carré, PHASE

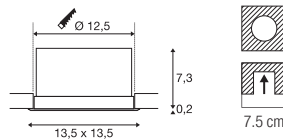

220-240V ~50/60Hz | 500mA
Puissance totale : 22W
Matière : aluminium / plastique

- Clips ressorts
- Épaisseur du support de montage : 25 mm max.



Down 1800lm | 3000K

Variante	Réf.	CHF
○ blanc	112692	149.00

DL 126
EL

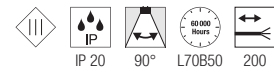
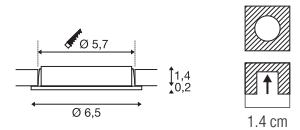

12 V DC
Puissance totale : 2,8W
Matière : aluminium / plastique

- Clips ressorts



Down 170lm | 3000K

Variante	Réf.	CHF
○ blanc	112221	41.60
● chrome	112222	48.00
● gris	112225	41.60



Article	Réf.	CHF
Alimentation LED 12/20W 24 V, avec serre-câble		
○ blanc	1005381	49.10
Alimentation LED 15W 12 V		
○ blanc	1005444	35.00

PIKA
DL, rond, QPAR51, fixe

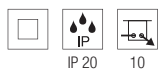
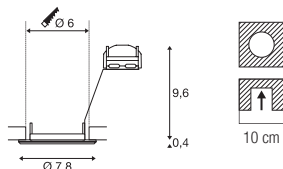

220-240V ~50/60Hz
Matière : aluminium

- Clips ressorts
- Épaisseur du support de montage : 13 mm max.



Douille : 1xGU10

Variante	Réf.	CHF
○ blanc	1000714	17.00
● laiton	1000716	21.30
● chrome	1000715	21.30
● gris	1000717	17.00



LED GU10 51mm | 6W | 38°
2700K | 450lm | CEE=F
6kWh / 1000h



Réf. : 1005077 | 10.60 CHF

PIKA
DL, rond, QPAR51, orientable

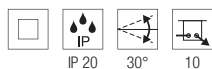
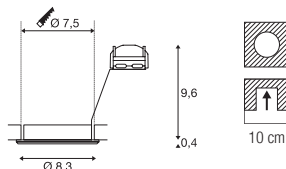

220-240V ~50/60Hz
Matière : aluminium

- Clips ressorts
- Épaisseur du support de montage : 15 mm max.



Douille : 1xGU10

Variante	Réf.	CHF
○ blanc	1000718	21.30
● laiton	1000720	24.50
● chrome	1000719	24.50
● gris	1000721	21.30



LED GU10 51mm | 6W | 38°
2700K | 450lm | CEE=F
6kWh / 1000h



Réf. : 1005075 | 10.60 CHF

1000719 228

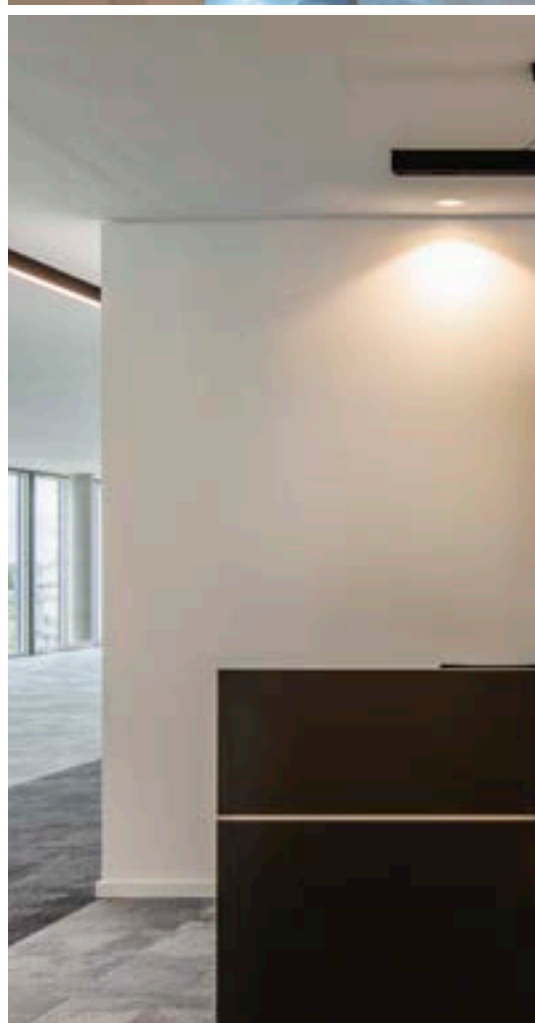
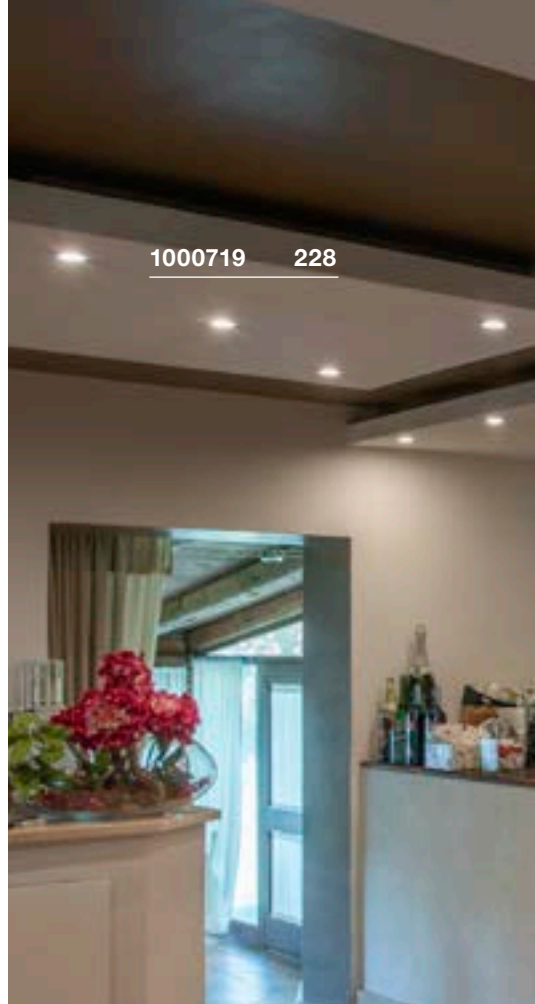



OCULUS CL, Move, PHASE

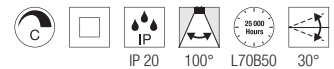
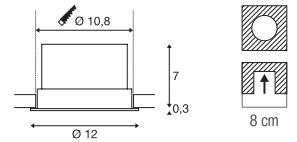

220-240V ~50/60Hz | 250mA

Puissance totale : 11W

Matière : aluminium / verre

- Clips ressorts
- Réflecteur dépoli supplémentaire inclus
- Épaisseur du support de montage : 20 mm max.



Down 36lm | 2000K - 780lm | 3000K

Variante	Réf.	CHF
● noir	1004668	259.00
○ blanc	1004669	259.00



1004669 229

OCCULDAS 14
EL, indirect, PHASE

OCCULDAS 23
EL, indirect, PHASE

117311 230

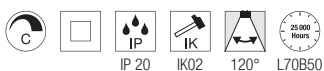
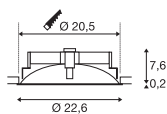
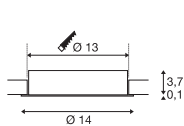

220-240V ~50/60Hz | 350mA
Puissance totale : 15W
Matière : aluminium / acier

- Clips ressorts
- Épaisseur du support de montage : 20 mm max.



Down 810lm | 3000K

Variante	Réf.	CHF
○ blanc	117331	202.00



220-240V ~50/60Hz | 700mA
Puissance totale : 23W
Matière : aluminium / acier

- Clips ressorts
- Épaisseur du support de montage : 30 mm max.



Down 1500lm | 3000K

Variante	Réf.	CHF
○ blanc	117311	359.00





CONTONE®
DL, rond, orientable, PHASE

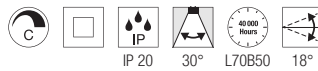
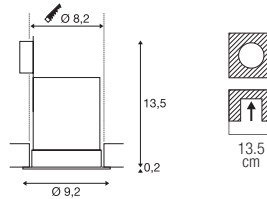

220-240V ~50/60Hz | 350mA
Puissance totale : 15W
Matière : aluminium

- Clips ressorts
- Épaisseur du support de montage : 25 mm max.



Down 1000lm | 2000-3000K

Variante	Réf.	CHF
○ blanc	161271	149.00



CONTONE®
DL, rond, fixe, PHASE

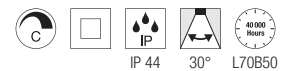
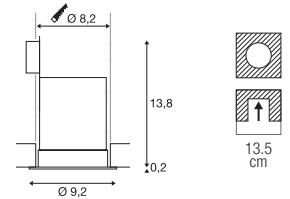

220-240V ~50/60Hz | 350mA
Puissance totale : 15W
Matière : aluminium

- Clips ressorts
- Épaisseur du support de montage : 25 mm max.



Down 1000lm | 2000-3000K

Variante	Réf.	CHF
○ blanc	161291	149.00



161271 231

H-LIGHT
DL, rond, PHASE

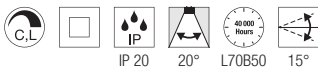
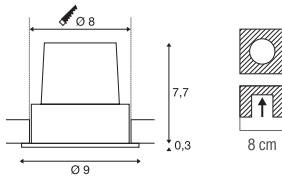

220-240V ~50/60Hz | 500mA
Puissance totale : 11W
Matière : aluminium

- Clips ressorts
- Épaisseur du support de montage : 30 mm max.



Down 265lm | 2700K

Variante	Réf.	CHF
● noir	114480	109.00
○ blanc	114481	109.00

KARPO 30
EL

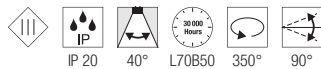
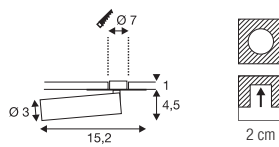

500mA
Puissance totale : 7,5W
Matière : aluminium / acier

- Épaisseur du support de montage : 12 mm max. / En cas d'installation de plusieurs luminaires, faire un câblage en série.
- Clips ressorts
- Fiche AMP fournie
- Épaisseur du support de montage : 12 mm max.



Down 450lm | 470lm | 3000K

Variante	Réf.	CHF
● noir		
450lm	152380	149.00
○ blanc		
470lm	152381	149.00



Article	Réf.	CHF
Driver LED 20W 350 mA/500mA PHASE		
○ blanc	1007227	46.00
Driver LED 25W 150-700mA variable DALI		
○ blanc	1007229	80.50
Driver LED 21W 500 mA, avec serre-câble		
○ blanc	1007226	34.50





148071 233

PLASTRA
RL, rond, QPAR51

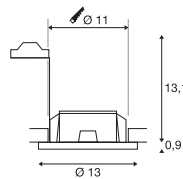

PLASTRA
RL, carré, QPAR51

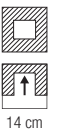
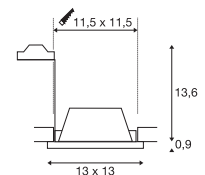

220-240V ~50/60Hz
Matière : plâtre / acier

- Clips ressorts
- Épaisseur du support de montage : 25 mm max.



220-240V ~50/60Hz
Matière : plâtre / acier

- Clips ressorts
- Épaisseur du support de montage : 30 mm max.



Douille : 1xGU10

Variante	Réf.	CHF
○ blanc	148070	55.00



LED GU10 51mm | 6W | 36°
2200-2700K | 360lm | CEE=G
6kWh / 1000h



Réf. : 1005273 | 12.90 CHF



Douille : 1xGU10

Variante	Réf.	CHF
○ blanc	148071	55.00



LED GU10 51mm | 6W | 38°
2700K | 450lm | CEE=F
6kWh / 1000h



Réf. : 1005076 | 10.60 CHF

DEKLED
EL

VARU
EL, QPAR51

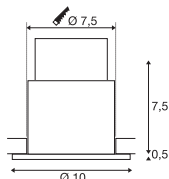
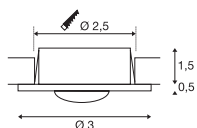

350mA
Puissance totale : 1W
Matière : aluminium / polycarbonate (PC)

- Clips ressorts
- Épaisseur du support de montage : 10 mm max.



Down 60lm | 3000K

Variante	Réf.	CHF
● gris	112242	35.20



Article	Réf.	CHF
Driver LED 350mA / 6 W variable		
○ blanc	1002791	35.20

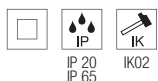

220-240V ~50/60Hz
Matière : aluminium / verre

- Clips ressorts
- Épaisseur du support de montage : 15 mm max.



Douille : 1xGU10 Ø max. : 5,1 cm

Variante	Réf.	CHF
● noir	1001930	49.10
○ blanc	1001931	49.10



LED GU10 51mm | 6W | 38°
2700K | 450lm | CEE=F
6kWh / 1000h



Réf. : 1005077 | 10.60 CHF

1001931 234



1001931 234





1001165 235



DOLIX OUT
EL, rond, QPAR51

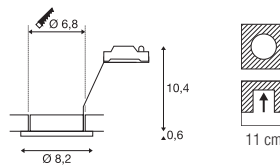

DOLIX OUT
EL, carré, QPAR51

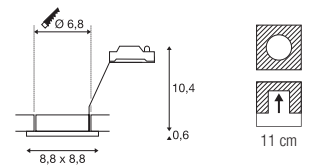

1001166 235

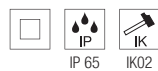

220-240V ~50/60Hz
Matière : aluminium / verre

- Clips ressorts
- Épaisseur du support de montage : 20 mm max.



Douille : 1xGU10

Variante	Réf.	CHF
○ blanc	1001165	48.00
● argent	1001168	49.10
● chrome	1001166	49.10
● gris	1001167	48.00



LED GU10 51mm | 6W | 36°
2200-2700K | 360lm | CEE=G



Réf. : 1005273 | 12.90 CHF

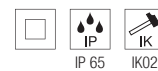

220-240V ~50/60Hz
Matière : aluminium / verre

- Clips ressorts
- Épaisseur du support de montage : 20 mm max.



Douille : 1xGU10

Variante	Réf.	CHF
○ blanc	1001169	48.00
● argent	1001172	49.10
● gris	1001171	48.00



LED GU10 51mm | 6W | 36°
2200-2700K | 360lm | CEE=G



Réf. : 1005273 | 12.90 CHF

1001015 236



KAMUELA ECO EL, rond, PHASE

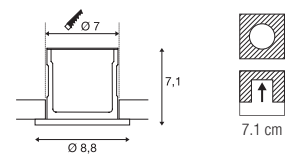

1001017 237

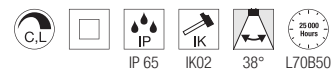

220-240V ~50Hz
Puissance totale : 6W
Matière : aluminium / plastique

- Clips ressorts
- Épaisseur du support de montage : 40 mm max.
- Résistant au feu pendant au moins 90 minutes selon BS 476-21



Down

500lm | 3000K

Variante	Réf.	CHF
● noir	1001015	45.90
○ blanc	1001016	45.90



KAMUELA ECO EL, rond, PHASE

KINI EL, PHASE

AKALO D83 EL

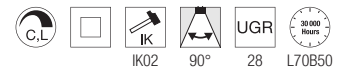
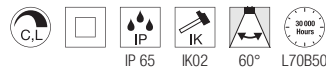
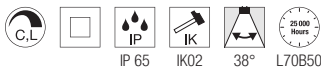
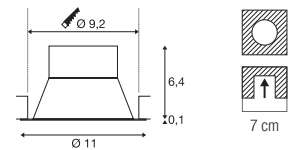
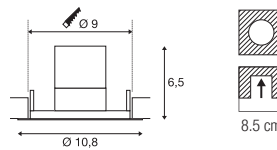
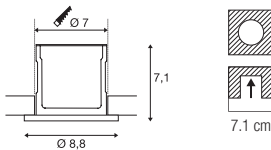

220-240V ~50Hz
Puissance totale : 6W
Matière : aluminium / plastique

- Clips ressorts
- Épaisseur du support de montage : 40 mm max.
- Résistant au feu pendant au moins 90 minutes selon BS 476-21

220-240V ~50/60Hz | 260mA
Puissance totale : 12W
Matière : aluminium / polycarbonate (PC)

- Clips ressorts
- Épaisseur du support de montage : 20 mm max.

220-240V ~50/60Hz | 120mA
Puissance totale : 9W
Matière : aluminium / polycarbonate (PC)

- Clips ressorts
- Épaisseur du support de montage : 20 mm max.



Down 530lm | 4000K



Down 850lm | 3000K



800lm | 3000K | 880lm | 4000K | 850lm | 5700K

Variante	Réf.	CHF
● noir	1001017	45.90
○ blanc	1001018	45.90

Variante	Réf.	CHF
○ blanc	1000833	152.00

Variante	Réf.	CHF
○ blanc	1001264	49.10

FRAME BASIC SET RL

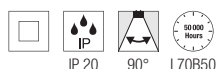
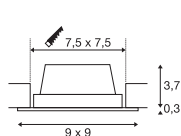

220-240V ~50/60Hz | 350mA
Puissance totale : 8,3W
Matière : aluminium / acrylique

- Clips ressorts
- Épaisseur du support de montage : 20 mm max.



Down 600lm | 3000K

Variante	Réf.	CHF
● noir	112720	70.00
○ blanc	112721	70.00

FRAME BASIC RL, HV

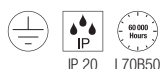
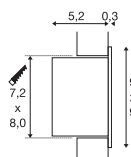

100-240V ~50/60Hz | 350mA
Puissance totale : 3W
Matière : aluminium

- Épaisseur du support de montage : 30 mm max.



Down 170lm | 2700K

Variante	Réf.	CHF
○ blanc	1000576	88.00
● gris	1000577	88.00



Article	Réf.	CHF
Boîte d'encastrement		
● noir	112781	13.80
Cadre d'encastrement		
● or	112780	7.40

FRAME BASIC

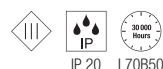
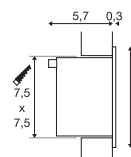

350mA
Puissance totale : 1W
Matière : aluminium / verre

- En cas d'installation de plusieurs luminaires, faire un câblage en série.
- Fiche AMP fournie
- Épaisseur du support de montage : 30 mm max.



Down 40lm | 3000K

Variante	Réf.	CHF
○ blanc	113262	48.00
● gris	111262	48.00



Article	Réf.	CHF
Boîte d'encastrement		
● noir	112781	13.80
Câble d'extension 1 m		
○ blanc	111861	10.60
Driver LED 3W 350 mA, avec fiche AMP		
○ blanc	1007270	22.80
Fiche de connexion 3 sorties		
● noir	111850	17.00
Cadre d'encastrement		
● or	112780	7.40



1000575 239

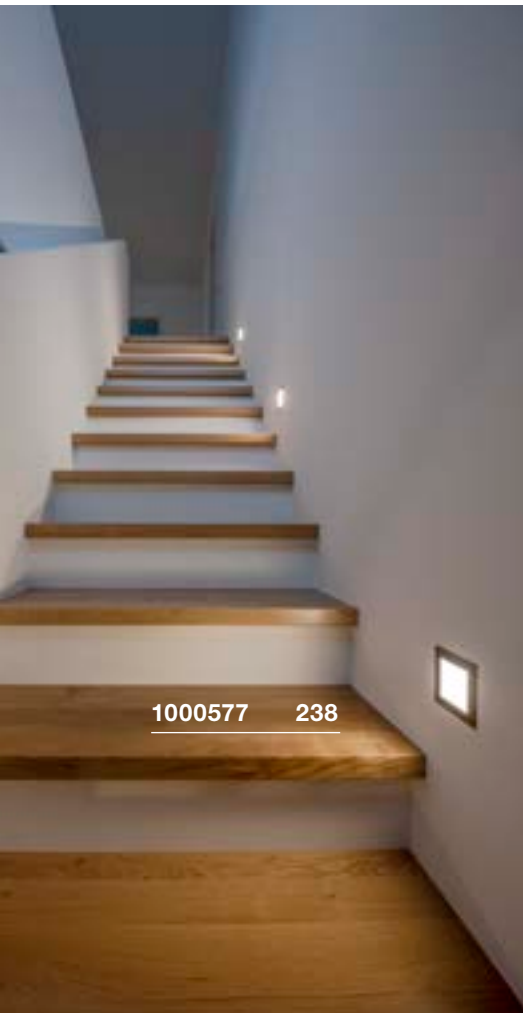

1000577 238

FRAME CURVE EL

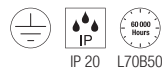
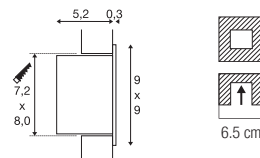

100-240V ~50/60Hz | 350mA
Puissance totale : 3W
Matière : aluminium

- Clips ressorts
- Épaisseur du support de montage : 30 mm max.



Down 140lm | 2700K

Variante	Réf.	CHF
○ blanc	1000574	96.00
● gris	1000575	96.00



Article	Réf.	CHF
Boîte d'encastrement		
● noir	112781	13.80
Cadre d'encastrement		
● or	112780	7.40

FRAME CURVE EL

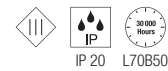
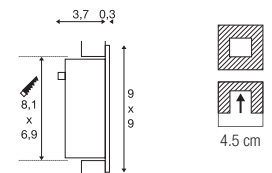

350mA
Puissance totale : 1W
Matière : aluminium

- En cas d'installation de plusieurs luminaires, faire un câblage en série.
- Clips ressorts
- Fiche AMP fournie
- Épaisseur du support de montage : 25mm max.



Down 60lm | 3000K

Variante	Réf.	CHF
○ blanc	113292	64.00
● gris	111292	64.00



Article	Réf.	CHF
Boîte d'encastrement		
● noir	112781	13.80
Câble d'extension 1 m		
○ blanc	111861	10.60
Driver LED 3W 350 mA, avec fiche AMP		
○ blanc	1007270	22.80
Fiche de connexion 3 sorties		
● noir	111850	17.00
Cadre d'encastrement		
● or	112780	7.40

QUAD FRAME 9 WL

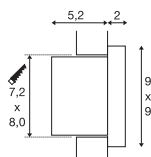

L70B50

100-240V ~50/60Hz | 350mA

Puissance totale : 3W

Matière : aluminium

- Épaisseur du support de montage : 30 mm max.



Down

75lm | 3000K

Variante	Réf.	CHF
○ blanc	1003466	115.00



Article	Réf.	CHF
Boîte d'encastrement		
● noir	112781	13.80
Cadre d'encastrement		
● or	112780	7.40

1003466 240





NOTAPO S RL

NOTAPO L RL



1002979 241

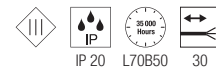
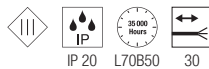
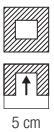
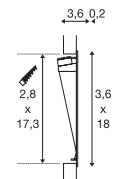
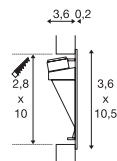

700mA
Puissance totale : 2,2W
Matière : aluminium

700mA
Puissance totale : 2,2W
Matière : aluminium

- En cas d'installation de plusieurs luminaires, faire un câblage en série.
- Lames ressorts
- Câble nu

- En cas d'installation de plusieurs luminaires, faire un câblage en série.
- Lames ressorts
- Câble nu



Down 6lm | 3000K

Down 6lm | 3000K

Variante	Réf.	CHF
○ blanc	1002979	70.00

Variante	Réf.	CHF
○ blanc	1002980	96.00



Article	Réf.	CHF
Driver LED 25W 150-700mA variable DALI		
○ blanc	1007229	80.50
Driver LED 3W 700mA avec serre-câble		
○ blanc	1007216	26.50
NOTAPO Cadre de montage		
● noir	1002981	27.70

Article	Réf.	CHF
Driver LED 10W 700mA variable, avec serre-câble		
○ blanc	1007213	40.30
Driver LED 3W 700mA avec serre-câble		
○ blanc	1007216	26.50
NOTAPO Cadre de montage		
● noir	1002981	27.70



1002980 241

DOWNUNDER PUR 80 EL

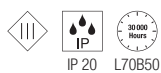
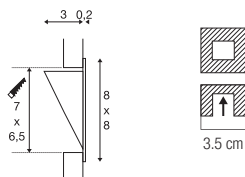

350mA
Puissance totale : 3,6W
Matière : aluminium / acier

- En cas d'installation de plusieurs luminaires, faire un câblage en série.
- Lames ressorts



Down 180lm | 3000K

Variante	Réf.	CHF
○ blanc	151950	79.00



Article	Réf.	CHF
Cadre de montage		
● gris	151960	12.75
Câble d'extension 1 m		
○ blanc	111861	10.60
Driver LED 3W 350 mA, avec fiche AMP		
○ blanc	1007270	22.80
Fiche de connexion 3 sorties		
● noir	111850	17.00

DOWNUNDER PUR 150 EL

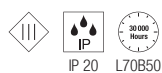
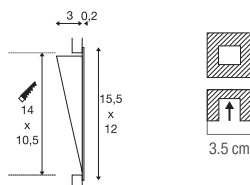

500mA
Puissance totale : 5,2W
Matière : aluminium / acier

- En cas d'installation de plusieurs luminaires, faire un câblage en série.
- Lames ressorts



Down 230lm | 3000K

Variante	Réf.	CHF
○ blanc	151952	117.00



Article	Réf.	CHF
Cadre de montage		
● gris	151962	17.00
Driver LED 20W 350 mA/500mA PHASE		
○ blanc	1007227	46.00
Driver LED 25W 150-700mA variable DALI		
○ blanc	1007229	80.50
Driver LED 21W 500 mA, avec serre-câble		
○ blanc	1007226	34.50

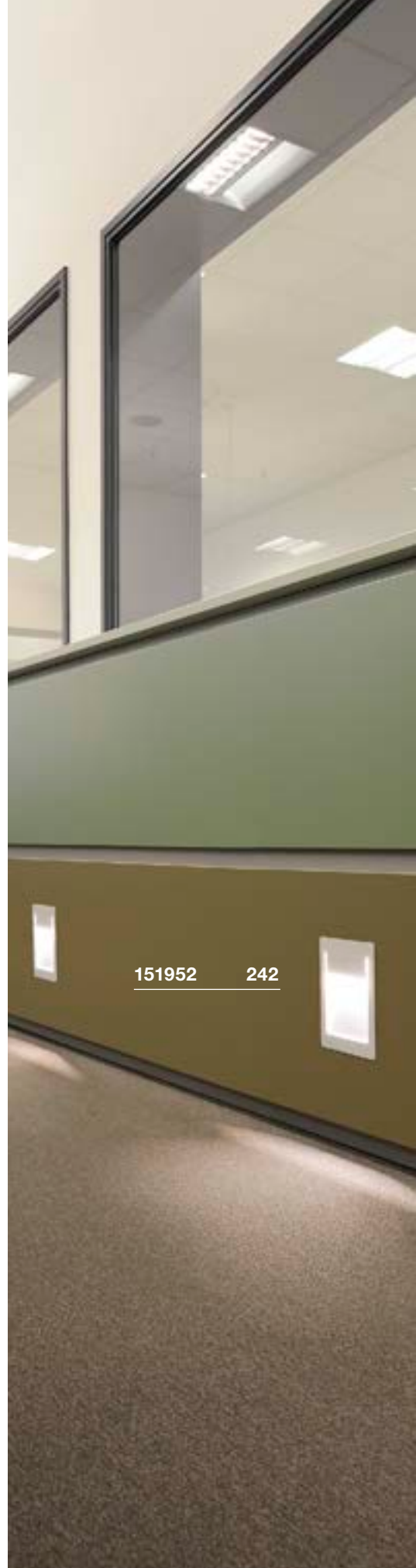

151952

242



MOBALA EL

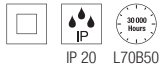
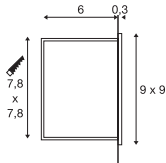

100-240V ~50/60Hz
Puissance totale : 1,3W
Matière : aluminium

- L'installation nécessite un cadre (1002984) ou une boîte d'encastrement (1002983).
- Lames ressorts



Down 14lm | 3000K

Variante	Réf.	CHF
○ blanc	1002982	85.00



Article	Réf.	CHF
Driver LED 3W 350 mA		
○ blanc	1005248	21.00

WORO EL

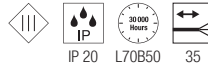
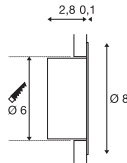

350mA
Puissance totale : 1,2W
Matière : acier

- En cas d'installation de plusieurs luminaires, faire un câblage en série.
- Cet article convient à une installation dans un boîtier pour cloison creuse ou pour interrupteur/prise.
- Clips ressorts
- Câble nu



Down 50lm | 3000K

Variante	Réf.	CHF
○ blanc	1002922	78.00



Article	Réf.	CHF
Driver LED 20W 350 mA/500mA PHASE		
○ blanc	1007227	46.00

LED PANEL 620x620mm

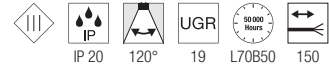
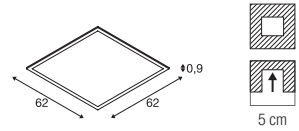

1050mA
Puissance totale : 35W
Matière : aluminium / polystyrène (PS)

- Câble nu



Down 4000lm | 3000K
4000K

Variante	Réf.	CHF
○ blanc		
3000K	1003073	239.00
○ blanc		
4000K	1003074	239.00



Article	Réf.	CHF
Kit de suspension 1,5 m		
● chrome	158799	28.00
Driver LED 40W 1050mA DALI variable avec interface RF		
○ blanc	1006197	125.00
Driver LED 40W 1050mA variable, avec serre-câble		
○ blanc	464804	70.00
Module RF pour driver DALI		
○ blanc	1006454	148.40
Module RF pour driver DALI		
○ blanc	1006199	43.70

PATTA-I
EL, rond, PHASE

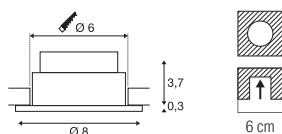

220-240V ~50/60Hz | 350mA
Puissance totale : 7,3W
Matière : aluminium / verre

- Clips ressorts. Des ressorts à lames sont également fournies.
- Épaisseur du support de montage : 20 mm max.



Down 440lm | 1800-3000K

Variante	Réf.	CHF
● noir	1002098	117.00
○ blanc	1002099	117.00
● alu brossé	1002100	117.00

PATTA-I
DL, carré, PHASE

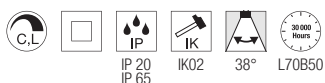
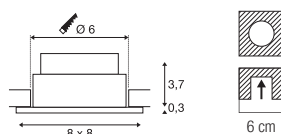

220-240V ~50/60Hz | 350mA
Puissance totale : 7,3W
Matière : aluminium / verre

- Clips ressorts. Des ressorts à lames sont également fournies.
- Épaisseur du support de montage : 20 mm max.



Down 440lm | 1800-3000K

Variante	Réf.	CHF
● noir	1002101	117.00
○ blanc	1002102	117.00

1002099 244



1002101 244





1002098 244

PATTA-I
EL, rond, PHASE

PATTA-I
EL, carré, PHASE

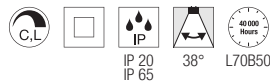
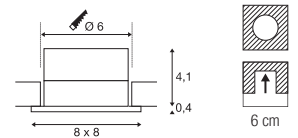
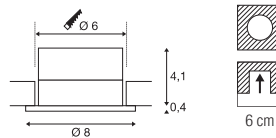

220-240V ~50/60Hz | 500mA
Puissance totale : 11W
Matière : aluminium / verre

- Clips ressorts
- Épaisseur du support de montage : 25 mm max.

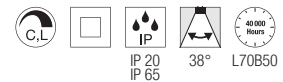

220-240V ~50/60Hz | 500mA
Puissance totale : 11W
Matière : aluminium / verre

- Clips ressorts
- Épaisseur du support de montage : 25 mm max.

114431 245



Down 910lm | 3000K

Variante	Réf.	CHF
● noir	114420	128.00
○ blanc	114421	128.00
● alu brossé	114426	138.00



Down 910lm | 3000K

Variante	Réf.	CHF
● noir	114430	128.00
○ blanc	114431	128.00
● alu brossé	114436	138.00

114451 247

PATTA-F
EL, rond, PHASE

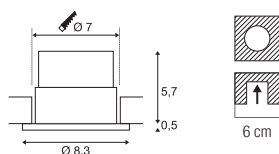

220-240V ~50/60Hz | 500mA
Puissance totale : 11W
Matière : aluminium / verre

- Clips ressorts
- Épaisseur du support de montage : 20 mm max.



Down 745lm | 3000K
860lm

Variante	Réf.	CHF
● noir 745lm	114440	128.00
○ blanc 860lm	114441	128.00





114450 247

PATTA-F
EL, carré, PHASE

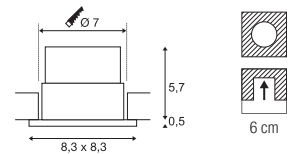

220-240V ~50/60Hz | 500mA
Puissance totale : 11W
Matière : aluminium / verre

- Clips ressorts
- Épaisseur du support de montage : 20 mm max.



Down 745lm | 3000K
860lm

Variante	Réf.	CHF
● noir		
745lm	114450	128.00
○ blanc		
860lm	114451	128.00





Retrouvez les **NUMINOS®** dans les pages familles 102-105

LED



Retrouvez les **MEDO®** dans les pages familles 164-165

LED



SCKET
VARYT | 251



LED
Q-LINE® | 253



LED
Q-LINE® | 253



SCKET
TRILEDO | 255



SCKET
TRILEDO | 255



SCKET
TRILEDO | 255



LED
TRILEDO | 257



LED
TRILEDO | 257



LED
TRILEDO | 257



LED
OCULUS | 258



SCKET
ENOLA B | 259



LED
ENOLA C | 259



SCKET
ASTINA | 261



SCKET
NAGY 75 | 261



LED
ANELA | 261



LED
OCCULDAS 13 | 262



LED
OCCULDAS 23 | 262



SCKET
ALTRA DICE | 263



SCKET
ALTRA DICE | 263



SCKET
KARDAMOD | 265



SCKET
KARDAMOD | 265



SCKET
FENDA | 266



FENDA | 267



FENDA | 267



FENDA | 267



SCKET
TENORA | 268



SCKET
SOPRANA | 269



SCKET
PLASTRA | 270



LED
PLASTRA | 271



SCKET
PLASTRA 105 | 271



SCKET
PLASTRA 104 | 271



LED
FERA 25 | 272



LED
FERA 25 | 272



LED
MARONA | 273



LED
PANEL 60 | 274



LED
PANEL | 275



LED
PANEL 60 | 275



LED
PANEL | 275

1007605 251

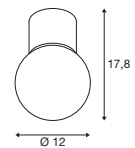

VARYT
CL, E14

220-240V ~50/60Hz
Matière : aluminium



Douille : 1xE14

Ø max. : 3,8 cm

L : 11 cm

Variante	Réf.	CHF
● noir	1007607	182.90
○ blanc	1007606	182.90
● chrome	1007604	207.00
● laiton	1007605	217.40



C35 | 4,2W | 320°
2700K | 350lm | CEE=G
5kWh / 1000h



Réf. : 1005285 | 12.90 CHF

1000692 253





Q-LINE®
CL, 1m, BAP, PHASE

Q-LINE®
CL, 2m, BAP, PHASE

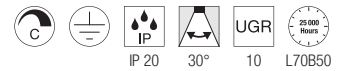
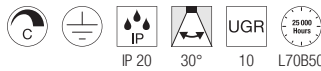
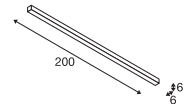
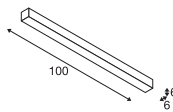

220-240V ~50/60Hz | 900mA
Puissance totale : 46W
Matière : aluminium / plastique

220-240V ~50/60Hz | 900mA
Puissance totale : 93W
Matière : aluminium / plastique



Down 2100lm | 3000K
2300lm | 4000K

Down 4200lm | 3000K
4600lm | 4000K

Variante	Réf.	CHF
● noir		
2100lm 3000K	1000686	549.00
○ blanc		
2100lm 3000K	1000685	549.00
● noir		
2300lm 4000K	1000689	549.00
○ blanc		
2300lm 4000K	1000688	549.00

Variante	Réf.	CHF
● noir		
4200lm 3000K	1000692	829.00
○ blanc		
4200lm 3000K	1000691	829.00
● noir		
4600lm 4000K	1000695	829.00
○ blanc		
4600lm 4000K	1000694	829.00

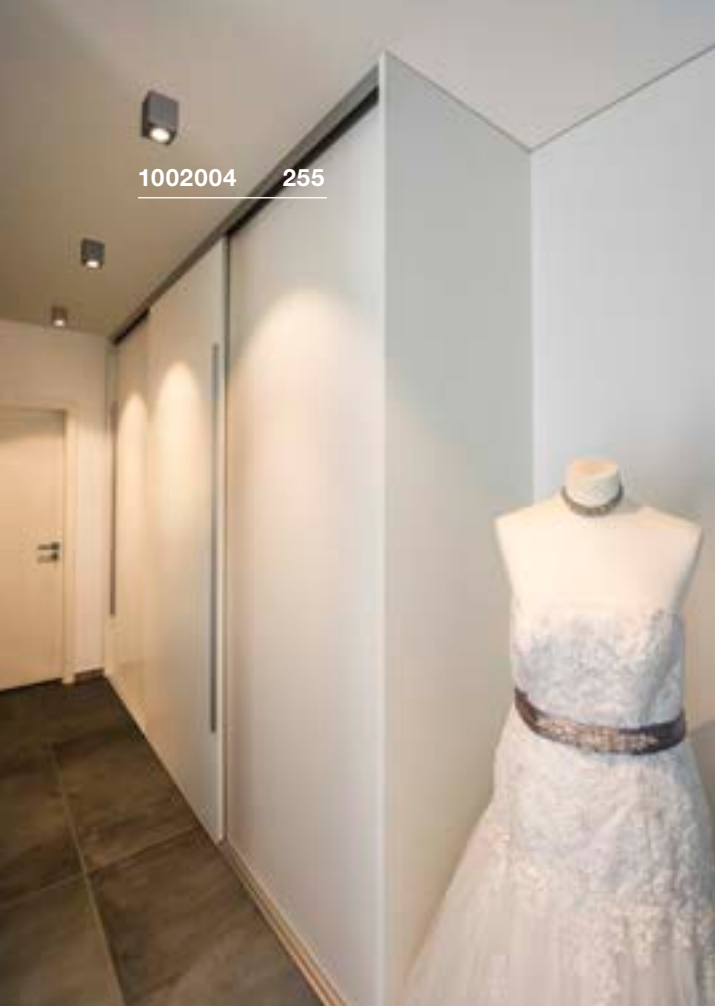

1002004 255



1002011 255



1002005 255



TRILEDO
CL, simple, carré, QPAR51

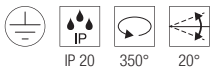
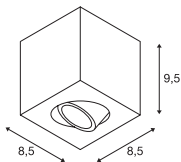

220-240V ~50/60Hz
Matière : aluminium



Douille : 1xGU10 Ø max. : 5,1 cm L : 5,5 cm

Variante	Réf.	CHF
● noir	1002013	117.00
○ blanc	1002015	117.00
● alu brossé	1002004	117.00



LED GU10 51 mm | 6W | 38°
2700K | 450lm | CEE=F
6kWh / 1000h



Réf. : 1005075 | 10.60 CHF

TRILEDO
CL, double, carré, QPAR51

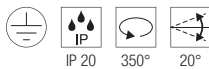
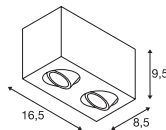

220-240V ~50/60Hz
Matière : aluminium



Douilles : 2xGU10 Ø max. : 5,1 cm L : 5,5 cm

Variante	Réf.	CHF
● noir	1002005	160.00
○ blanc	1002006	160.00



LED GU10 51 mm | 6W | 38°
2700K | 450lm | CEE=F
6kWh / 1000h



Réf. : 1005077 | 10.60 CHF

TRILEDO
CL, simple, rond, QPAR51

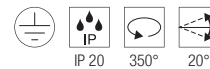
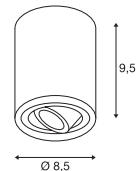

220-240V ~50/60Hz
Matière : aluminium



Douille : 1xGU10 Ø max. : 5,1 cm L : 5,5 cm

Variante	Réf.	CHF
● noir	1002010	117.00
○ blanc	1002011	117.00
● alu brossé	1002012	117.00



LED GU10 51 mm | 6W | 38°
2700K | 450lm | CEE=F
6kWh / 1000h



Réf. : 1005075 | 10.60 CHF

113940 257



113931 257



1002003 257





TRILEDO
CL, simple, carré

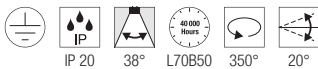
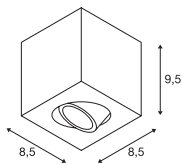

220-240V ~50/60Hz | 350mA
Puissance totale : 7,6W
Matière : aluminium / aluminium



Down 640lm | 3000K

Variante	Réf.	CHF
● noir	113940	138.00
○ blanc	113941	138.00

TRILEDO
CL, double, carré

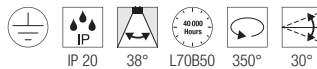
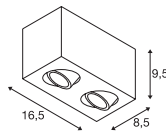

220-240V ~50/60Hz | 350mA
Puissance totale : 14W
Matière : aluminium



Down 1300lm | 3000K

Variante	Réf.	CHF
● noir	1002003	209.00
○ blanc	1002008	209.00

TRILEDO
CL, simple, rond

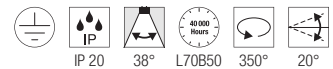
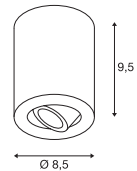

220-240V ~50/60Hz | 350mA
Puissance totale : 7,6W
Matière : aluminium / aluminium



Down 640lm | 3000K

Variante	Réf.	CHF
● noir	113930	138.00
○ blanc	113931	138.00

OCULUS CL, PHASE

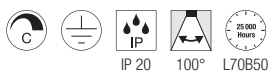
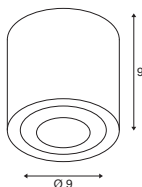

220-240V ~50/60Hz | 250mA
Puissance totale : 11W
Matière : aluminium / verre

- Réflecteur dépoli supplémentaire inclus



Down 36lm | 2000K - 780lm | 3000K

Variante	Réf.	CHF
● noir	1004666	269.00
○ blanc	1004667	269.00

1004667 258

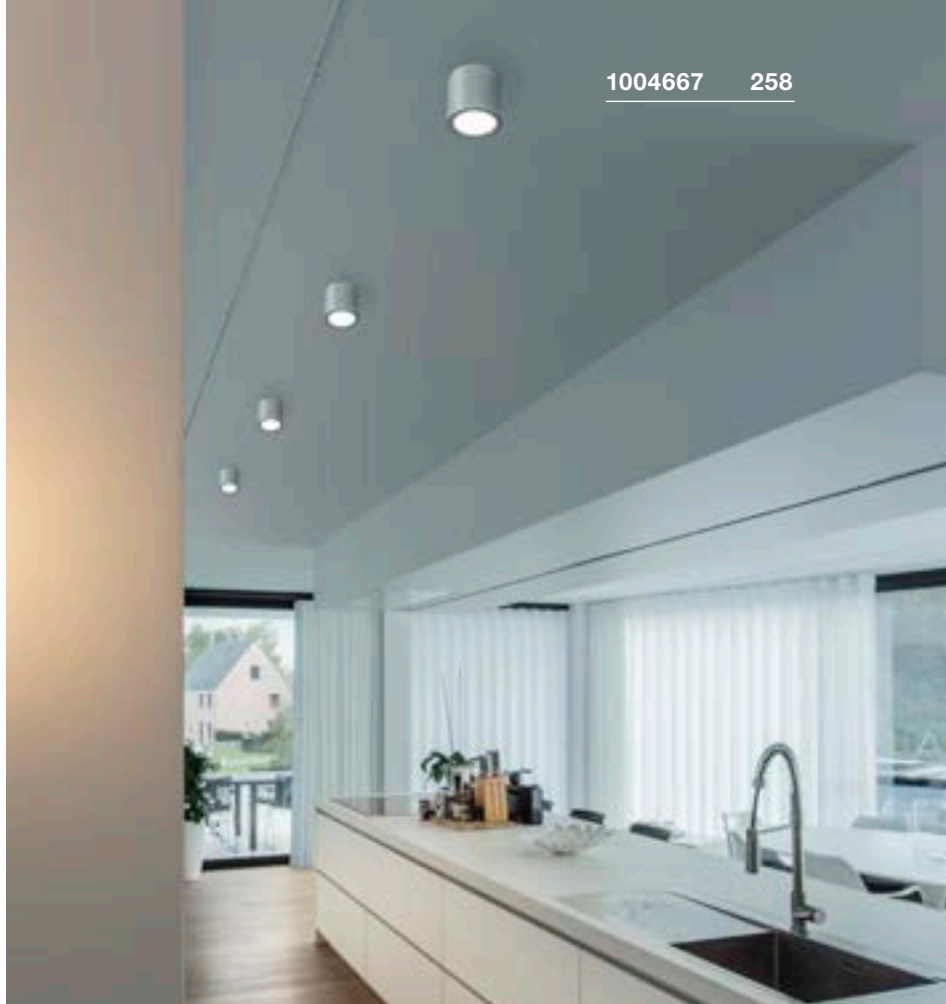

151811 259





ENOLA B
CL, QPAR51

ENOLA C
CL

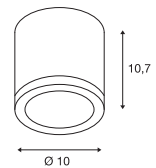
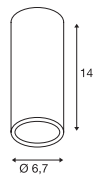

220-240V ~50/60Hz
Matière : aluminium

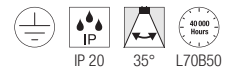

220-240V ~50/60Hz | 500mA
Puissance totale : 11W
Matière : aluminium



Douille : 1xGU10

L max. : 8,5 cm



Down

1020lm | 3000K

Variante	Réf.	CHF
● noir	151810	85.00
○ blanc	151811	85.00

Variante	Réf.	CHF
○ blanc	152101	279.00



LED GU10 51 mm | 6W | 36°
2200-2700K | 360lm | CEE=G
6kWh / 1000h



Réf. : 1005273 | 12.90 CHF



Articlé	Ref.	CHF
Anneau décoratif		
● noir	151840	12.75



1002936 261



1002965 261



1000808 261

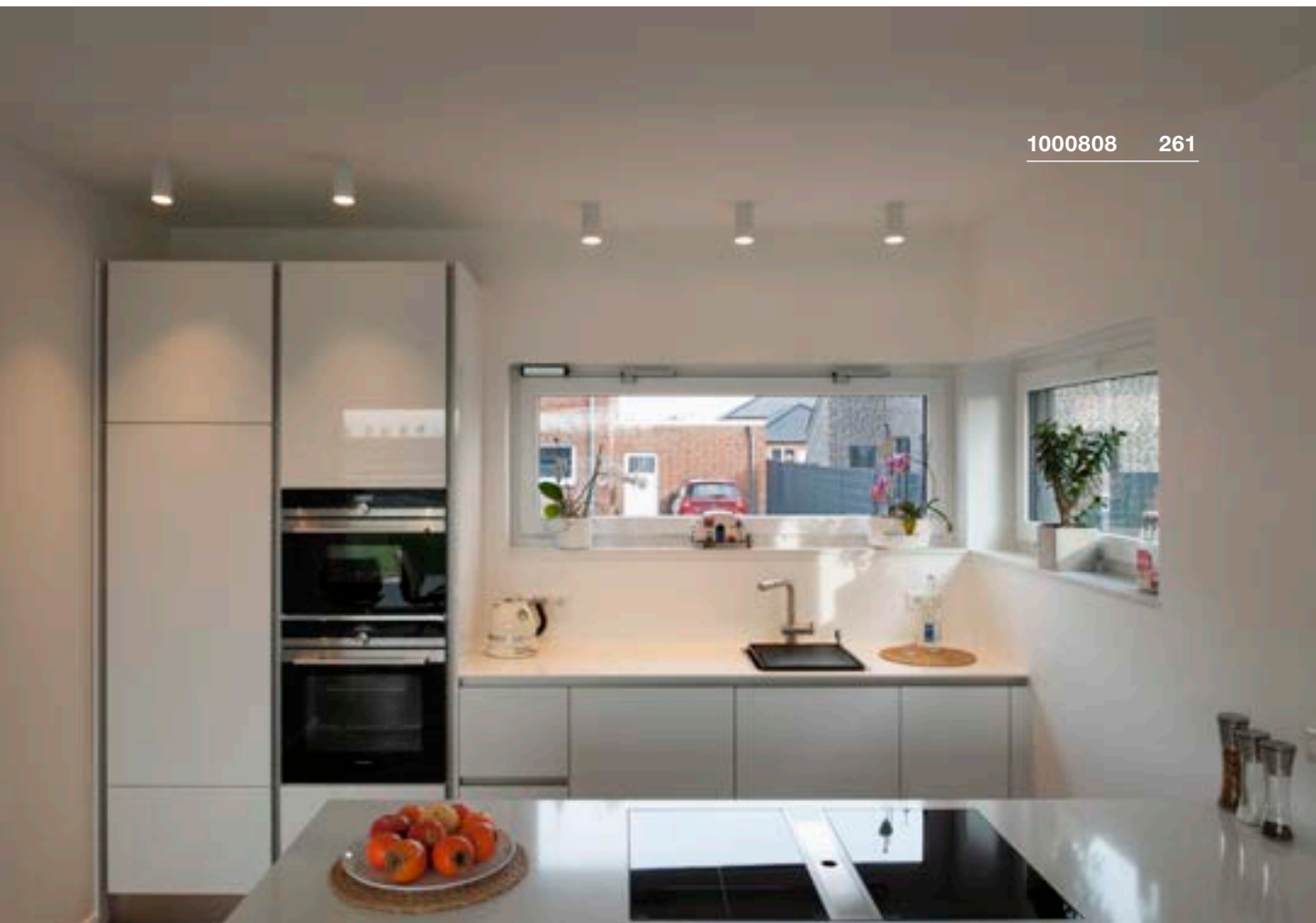



ASTINA
CL, QPAR51

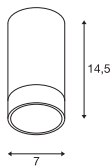

220-240V ~50/60Hz
Matière : aluminium



Douille : 1xGU10

Variante	Réf.	CHF
● noir	1002936	117.00
○ blanc	1002934	117.00



LED GU10 51 mm | 6W | 38°
2700K | 450lm | CEE=F
6kWh / 1000h



Réf. : 1005075 | 10.60 CHF

NAGY 75
CL, QPAR51

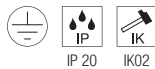
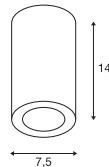

220-240V ~50/60Hz
Matière : plâtre



Douille : 1xGU10

Variante	Réf.	CHF
○ blanc	1002965	64.00



LED GU10 51 mm | 6W | 36°
2200-2700K | 360lm | CEE=G
6kWh / 1000h



Réf. : 1005273 | 12.90 CHF

ANELA
CL, PHASE

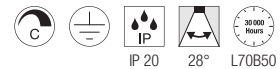
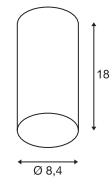

220-240V ~50/60Hz | 500mA
Puissance totale : 10W
Matière : aluminium



Down 220lm | 3000K | 750lm | 3000K

Variante	Réf.	CHF
● noir	1000807	209.00
○ blanc	1000808	209.00



Article	Réf.	CHF
Réflecteur 28°		
● noir	1000811	24.50
○ blanc	1000812	24.50
● or	1000809	24.50
● gris	1000810	24.50

OCCULDAS 13
CL, indirect, PHASE

OCCULDAS 23
CL, indirect, PHASE

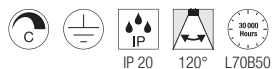
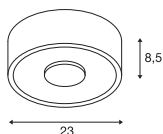
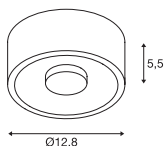

220-240V ~50/60Hz | 350mA
Puissance totale : 15W
Matière : aluminium

220-240V ~50/60Hz | 700mA
Puissance totale : 24W
Matière : aluminium / acier



Down 810lm | 3000K



Down 1500lm | 3000K

Variante	Réf.	CHF
○ blanc	117351	259.00

Variante	Réf.	CHF
○ blanc	117321	399.00

117321 262



1002216 263





ALTRA DICE
CL, QPAR51

ALTRA DICE
CW, double, QPAR51

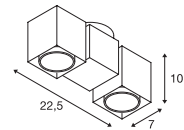
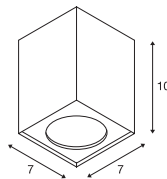

1002215 263



220-240V ~50/60Hz
Matière : aluminium / acier



Douille : 1xGU10

Variante	Réf.	CHF
● noir	1002216	85.00
○ blanc	151511	85.00
●● gris / noir	151514	85.00



LED GU10 51 mm | 6W | 38°
2700K | 450lm | CEE=F
6kWh / 1000h



Réf. : 1005077 | 10.60 CHF

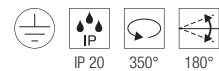

220-240V ~50/60Hz
Matière : aluminium / acier



Douilles : 2xGU10

Variante	Réf.	CHF
● noir	1002215	156.00
○ blanc	151531	156.00
● gris	151534	156.00



LED GU10 51 mm | 6W | 36°
2200-2700K | 360lm | CEE=G
6kWh / 1000h



Réf. : 1005273 | 12.90 CHF

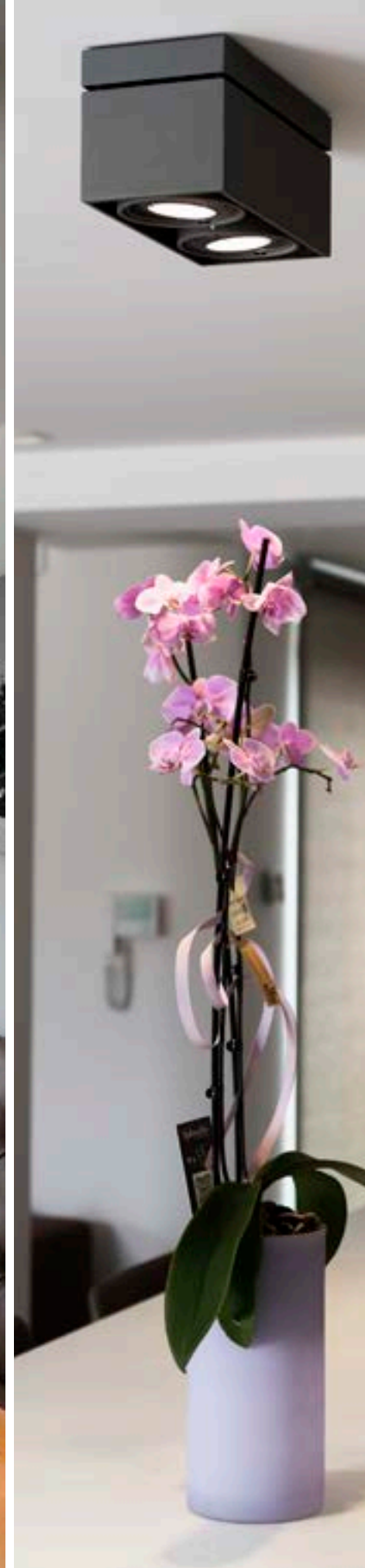



KARDAMOD
CL, simple, carré, QPAR111

KARDAMOD
CL, double, carré, QPAR111

117110 265

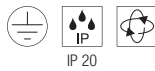
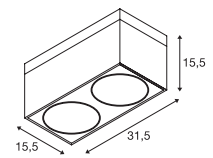
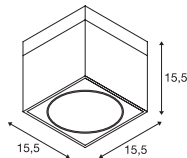

IP 20

220-240V ~50/60Hz
Matière : acier



Douille : 1xGU10

Variante	Réf.	CHF
● noir	117100	179.00
○ blanc	117101	179.00



QPAR111 | 12,5W | 30°
2700K | 950lm | CEE=F
13kWh / 1000h



Réf. : 1005276 | 62.00 CHF

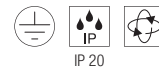

IP 20

220-240V ~50/60Hz
Matière : acier



Douilles : 2xGU10

Variante	Réf.	CHF
● noir	117110	299.00
○ blanc	117111	299.00



QPAR111 | 8W | 38°
2700K | 680lm | CEE=F
8kWh / 1000h



Réf. : 1005274 | 35.20 CHF

FENDA
Patère, E27

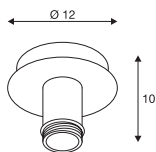

220-240V ~50/60Hz
Matière : acier



Douille : 1xE27

Variante	Réf.	CHF
● noir	155550	59.00
○ blanc	155551	59.00



LED E27 | 7,5W | 320°
2700SK | 800lm | CEE=F
8kWh / 1000h



Ref. : 1005268 | 13.80 CHF

155551 + 1004775 266 + 267





FENDA

30 cm, rond



H : 20 cm
 Ø : 30 cm
 Matière : textile / acier

FENDA

Ø 45 cm, rond



H : 28 cm
 Ø : 45,5 cm
 Matière : textile / acier

FENDA

Ø 70 cm, rond



H : 36 cm
 Ø : 70 cm
 Matière : textile / acier

- Non compatible avec Fenda Bow.

Variante	Réf.	CHF
●● noir / cuivre	155592	85.00
○ blanc	155582	64.00
● gris	1004774	64.00
● beige	155583	64.00

Variante	Réf.	CHF
●● noir / cuivre	156122	117.00
○ blanc	156111	102.00
● gris	1004775	102.00
● beige	156113	102.00

Variante	Réf.	CHF
●● noir / cuivre	1000580	156.00
○ blanc	1000579	138.00



156050 268

TENORA CL, E27

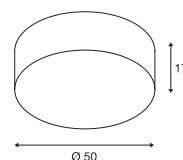

220-240V ~50/60Hz
Matière : acier / textile



Douilles : 3xE27

L max. : 14,8 cm

Variante	Réf.	CHF
● noir	156050	229.00
○ blanc	156051	229.00



LED E27 | 13,2W | 220°
2700K | 1300lm | CEE=F
13kWh / 1000h



Réf. : 1005302 | 17.00 CHF

SOPRANA

CL, E27

155373 269

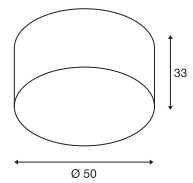

220-240V ~50/60Hz
Matière : acier / textile



Douilles : 3xE27

Variante	Réf.	CHF
● beige	155373	225.00



A60 | 7,5W | 320°
2700K | 800lm | CEE=F
8kWh / 1000h



Réf. : 1005303 | 12.90 CHF

148004 270



PLASTRA
CL, QPAR51

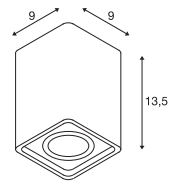

148005 271



220-240V ~50/60Hz
Matière : plâtre / acier

SOCKET
INSIDE <35
W

Douille : 1xGU10

Variante	Réf.	CHF
○ blanc	148004	85.00



LED GU10 51 mm | 6W | 38°
2700K | 450lm | CEE=F
6kWh / 1000h



Réf. : 1005077 | 10.60 CHF



PLASTRA
CL, PHASE

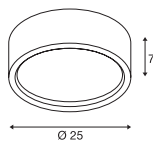

220-240V ~50/60Hz | 350mA
Puissance totale : 15W
Matière : plâtre / verre



Down 990lm | 3000K

Variante	Réf.	CHF
○ blanc	148005	160.00

PLASTRA 105
CL, E27

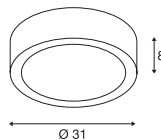

220-240V ~50/60Hz
Matière : plâtre / verre



Douilles : 2xE27 Ø max. : 5,1 cm | L : 14 cm

Variante	Réf.	CHF
○○ blanc / transparent	148001	117.00



LED E27 | 8W | 240°
4000K | 920lm | CEE=E
8kWh / 1000h



Réf. : 1005290 | 12.90 CHF

PLASTRA 104
CL, E27

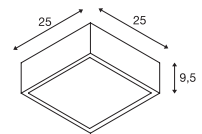

220-240V ~50/60Hz
Matière : plâtre / verre



Douilles : 2xE27 Ø max. : 5,1 cm | L : 14 cm

Variante	Réf.	CHF
○○ blanc / transparent	148002	106.00



LED E27 | 8W | 240°
4000K | 920lm | CEE=E
8kWh / 1000h



Réf. : 1005290 | 12.90 CHF

FERA 25
CL, DALI

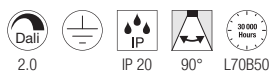
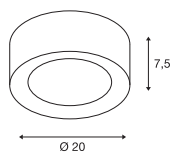

220-240V ~50/60Hz | 500mA
Puissance totale : 20W
Matière : polycarbonate (PC) /
polyméthacrylate de méthyle (PMMA)



Down 1580lm | 3000K | 1650lm | 4000K

Variante	Réf.	CHF
● noir	1002968	339.00
○ blanc	1002967	339.00

FERA 25
CL

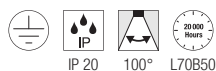
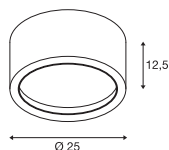

220-240V ~50/60Hz | 550mA
Puissance totale : 23W
Matière : aluminium / polystyrène (PS)



Down 1800lm | 3000K

Variante	Réf.	CHF
● noir	1001939	239.00
○ blanc	161461	259.00

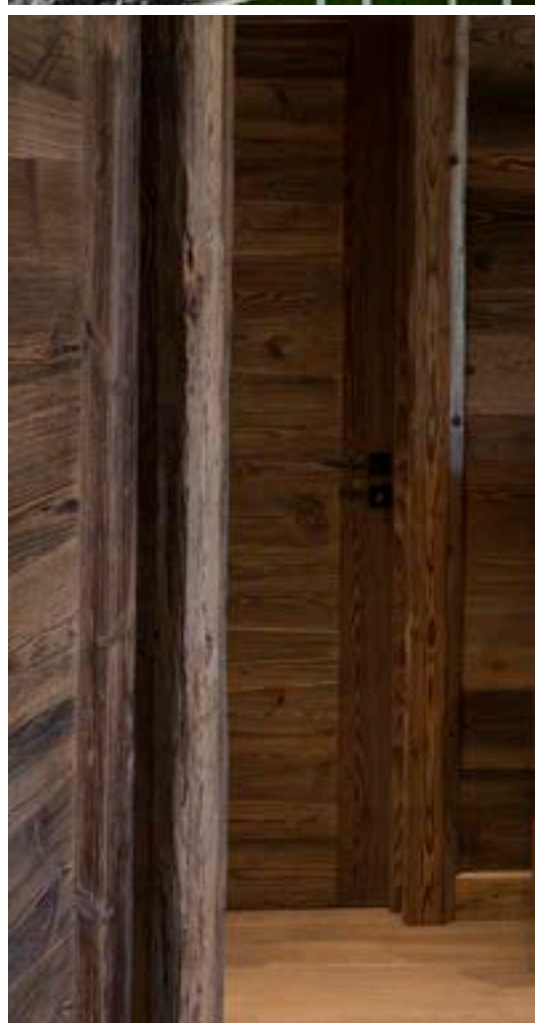
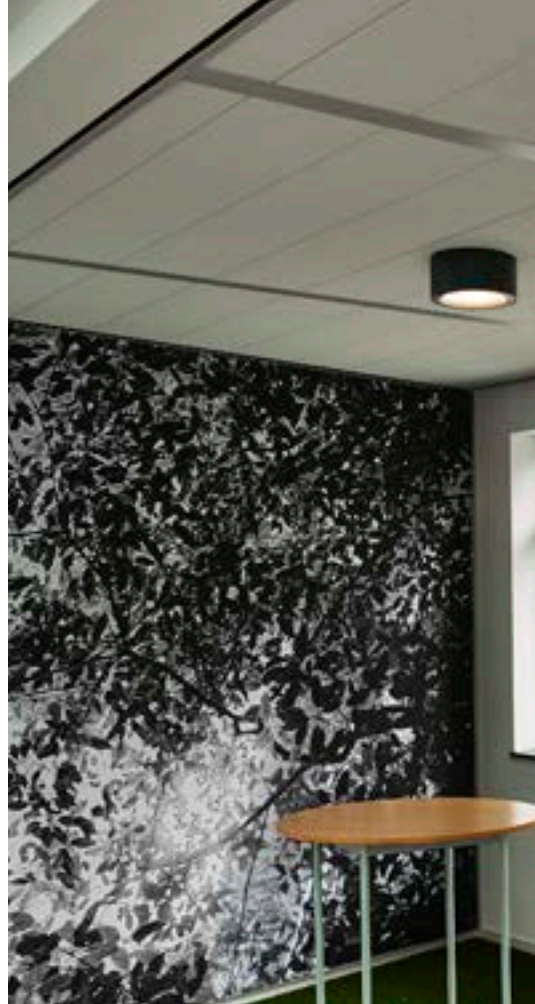



1001939 272

MARONA
CL, PHASE

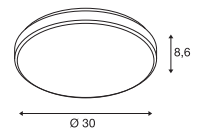

155156 273

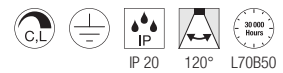

220-240V ~50/60Hz | 430mA
 Puissance totale : 15W
 Matière : polyméthacrylate de méthyle (PMMA) / acier



Down 1200lm | 3000K

Variante	Réf.	CHF
● gris	155156	139.00



1000785 274

PANEL 60
CL, rond, PHASE

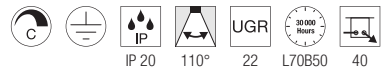
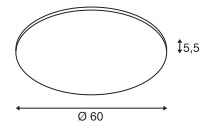

220-240V ~50/60Hz | 1000mA
Puissance totale : 42W
Matière : aluminium / polyméthacrylate
de méthyle (PMMA)



Down 3150lm | 3000K
3350lm | 4000K

Variante	Réf.	CHF
○ blanc 3150lm 3000K	1000783	359.00
○ blanc 3350lm 4000K	1000784	359.00
● gris 3150lm 3000K	1000785	359.00
● gris 3350lm 4000K	1000786	359.00



PANEL
CL, 1200x300mm, PHASE

PANEL 60
CL, rond, DALI

PANEL
CL, 1200x300mm, DALI

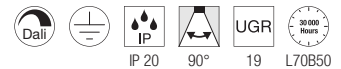
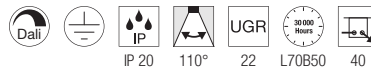
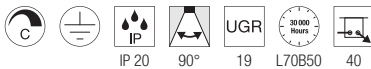
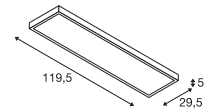
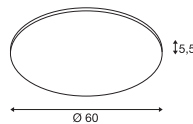
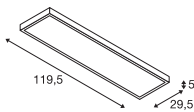

220-240V ~50/60Hz | 1000mA
Puissance totale : 45W
Matière : aluminium / plastique

120-277V ~50/60Hz | 1000mA
Puissance totale : 43W
Matière : aluminium / polyméthacrylate
de méthyle (PMMA)

120-277V ~50/60Hz | 1000mA
Puissance totale : 43W
Matière : aluminium / polyméthacrylate
de méthyle (PMMA)



Down 3100lm | 3000K
3400lm | 4000K

Down 3150lm | 3000K
3350lm | 4000K

Down 3100lm | 3000K
3400lm | 4000K

Variante	Réf.	CHF
○ blanc		
3100lm 3000K IRC80	1001505	339.00
○ blanc		
3400lm 4000K IRC80	1001506	339.00
● gris		
3100lm 3000K IRC80	1001508	339.00
● gris		
3400lm 4000K IRC90	1001509	339.00

Variante	Réf.	CHF
○ blanc		
3150lm 3000K	1003040	359.00
○ blanc		
3350lm 4000K	1003041	359.00
● gris		
3150lm 3000K	1003042	359.00
● gris		
3350lm 4000K	1003043	359.00

Variante	Réf.	CHF
○ blanc		
3100lm 3000K	1003052	339.00
○ blanc		
3400lm 4000K	1003053	339.00
● gris		
3100lm 3000K	1003054	339.00
● gris		
3400lm 4000K	1003055	339.00



Retrouvez les **NUMINOS®** dans les pages familles 106–109

LED



Retrouvez les **MEDO®** dans les pages familles 166–167

LED



NEW

Retrouvez les **LALU®** dans les pages familles 176–185

LED



Retrouvez les **ONE®** dans les pages familles 186–191

LED



SCKET
PANTILO ROPE 19 | 279



SCKET
PANTILO ROPE 20 | 279



SCKET
PANTILO ROPE 27 | 279

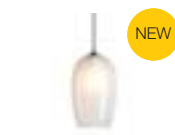

SCKET
PANTILO OVAL | 281



SCKET
PANTILO 20 | 281



SCKET
PANTILO 28 | 281



SCKET
PANTILO CONVEX 29 | 283



SCKET
PANTILO CONVEX 40 | 283



SCKET
ASTO TUBE | 285



SCKET
ASTO TUBE | 285



SCKET
ASTO TUBE | 285



SCKET
ASTO TUBE | 285



LED
WORKLIGHT PRO 120 | 287



LED
WORKLIGHT PRO 150 | 287



LED
WORKLIGHT | 288



LED
I-PENDANT PRO | 289



LED
PANEL 60 | 289



LED
NOYA | 290



LED
GLENOS® | 291



LED
GLENOS® | 291



LED
Q-LINE® | 293



LED
Q-LINE® | 293



LED
Q-LINE® | 293



LED
OCULUS | 294



SCKET
FITU | 295



SCKET
FENDA | 296



FENDA | 296



FENDA | 296



FENDA | 297



FENDA | 297



FENDA | 297



LED
HELIA
AMBIENT 35 | 300



LED
HELIA
AMBIENT 35 | 300



LED
HELIA 30 | 301



LED
HELIA 30 | 301



LED
HELIA 40 | 303



LED
HELIA 40 | 303



SCKET
ASTINA | 305



SCKET
ENOLA B | 305



SCKET
ENOLA | 305



LED
ANELA | 306



SCKET
LISENNE | 306



SCKET
TONGA® | 307



SCKET
QUADRASS | 307



SCKET
PARA CONE GL | 309



SCKET
PARA CONE 20 | 309



SCKET
PARA CONE 30 | 309



SCKET
PHELIA 10 | 310



SCKET
PHELIA 20 | 311



SCKET
PHELIA 25 | 311



SCKET
PHELIA 30 | 311



SCKET
FORCHINI 50 | 312



SCKET
FORCHINI 70 | 312



SCKET
FORCHINI M 40 | 313



SCKET
FORCHINI M 50 | 313



SCKET
LIGHT EYE® 90 | 314



SCKET
LIGHT EYE® 150 | 314



SCKET
SUN / BIG SUN | 315



SCKET
ROTOBALL 25 | 317



SCKET
ROTOBALL 40 | 317



SCKET
ROTOBALL 50 | 317



SCKET
PARA DOME | 318



PARA DOME | 318



PARA DOME | 318



SCKET
PARA 380 | 319



1007588 279

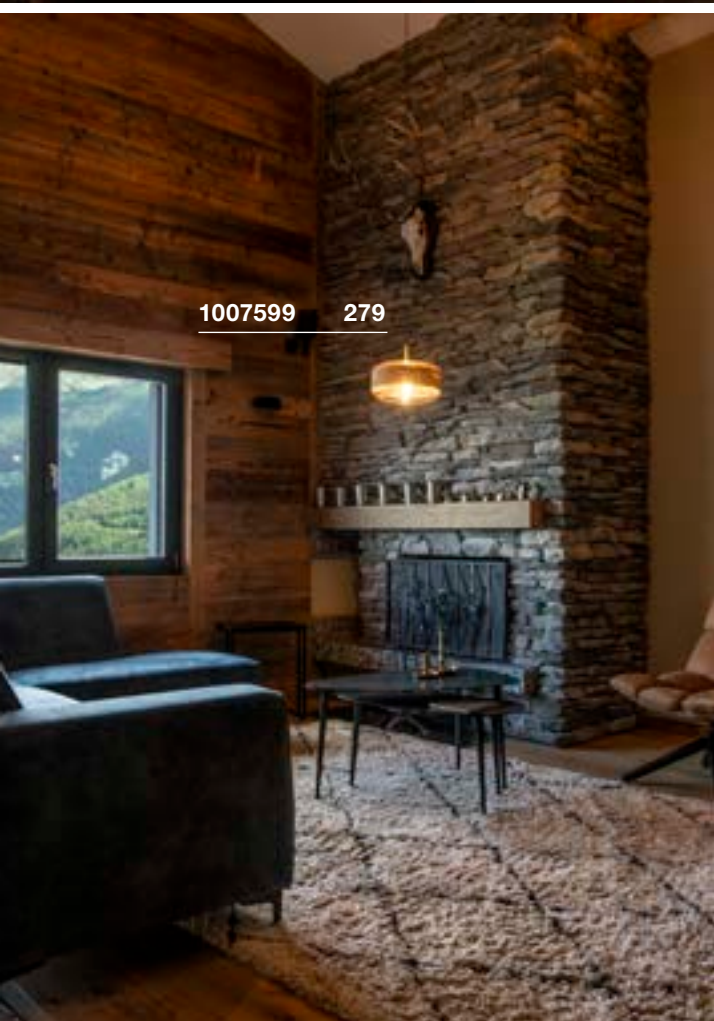

1007599 279



1007597 279



PANTILO ROPE 19 PD, E27

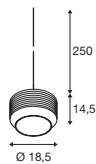

200-240V ~50/60Hz
Matière : verre / acier / chanvre

- Câble nu



Douille : 1xE27 Ø max. : 10 cm L : 11 cm

Variante	Réf.	CHF
● ambre / or	1007597	228.90
● anthracite / argent	1007596	228.90



A60 | 7,5W | 180°
2700K | 720lm | CEE=F
8kWh / 1000h



Réf. : 1005305 | 24.50 CHF



Article	Réf.	CHF
Adaptateur 1 allumage		
● noir	143120	17.00
○ blanc	143121	17.00
● gris	143124	17.00
Adaptateur 3 allumages		
● noir	145990	24.50
● gris	145994	24.50
○ blanc	1001542	24.50
Fitu Patère 1 passe-fil, rond		
● noir	132600	33.00
○ blanc	132601	33.00
● or	1002163	35.20
● chrome	132605	35.20

PANTILO ROPE 20 PD, E27

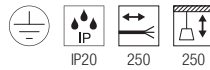
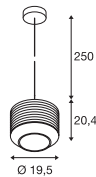

200-240V ~50/60Hz
Matière : verre / acier / chanvre



Douille : 1xE27 Ø max. : 10 cm L : 18 cm

Variante	Réf.	CHF
● ambre / or	1007589	274.90
● anthracite / argent	1007588	274.90



A60 | 7,5W | 180°
2700K | 720lm | CEE=F
8kWh / 1000h



Réf. : 1005305 | 24.50 CHF

PANTILO ROPE 27 PD, E27

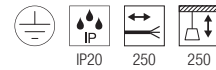
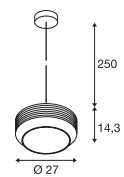

200-240V ~50/60Hz
Matière : verre / acier / chanvre



Douille : 1xE27 Ø max. : 15 cm L : 11 cm

Variante	Réf.	CHF
● ambre / or	1007599	297.90
● anthracite / argent	1007598	297.90



A60 | 7,5W | 180°
2700K | 720lm | CEE=F
8kWh / 1000h



Réf. : 1005305 | 24.50 CHF

1006403 281





PANTILO OVAL PD, E27

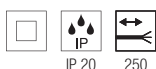
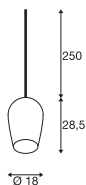

200-240V ~50/60Hz
Matière : verre

- Câble nu



Douille : 1xE27

Variante	Réf.	CHF
○ blanc	1006402	185.00
● or	1006403	209.00
● chrome	1006398	209.00
● cuivre	1006400	209.00



A60 | 7,5W | 180°
2700K | 720lm | CEE=F
8kWh / 1000h



Réf. : 1005305 | 24.50 CHF



Article	Réf.	CHF
Adaptateur 1 allumage		
● noir	143120	17.00
○ blanc	143121	17.00
● gris	143124	17.00
Adaptateur 3 allumages		
● noir	145990	24.50
● gris	145994	24.50
○ blanc	1001542	24.50
Patère en saillie		
● noir	1004744	42.65
○ blanc	1004745	42.65
● chrome	1004746	49.10
Fitu Patère 1 passe-fil		
○ blanc	132601	33.00
● or	1002163	35.20
FITU Patère 1 passe-fil, rond		
● noir	132600	33.00
● chrome	132605	35.20

PANTILO 20 PD, E27

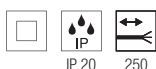
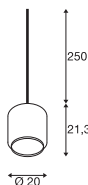

200-240V ~50/60Hz
Matière : verre

- Câble nu



Douille : 1xE27

Variante	Réf.	CHF
○ blanc	1006396	185.00
● or	1006395	209.00
● chrome	1003004	209.00
● cuivre	1003005	209.00



A60 | 7,5W | 180°
2700K | 720lm | CEE=F
8kWh / 1000h



Réf. : 1005305 | 24.50 CHF



Article	Réf.	CHF
Adaptateur 1 allumage		
● noir	143120	17.00
○ blanc	143121	17.00
● gris	143124	17.00
Adaptateur 3 allumages		
● noir	145990	24.50
● gris	145994	24.50
○ blanc	1001542	24.50
Fitu Patère 1 passe-fil		
○ blanc	132601	33.00
● or	1002163	35.20
FITU Patère 1 passe-fil, rond		
● noir	132600	33.00
● chrome	132605	35.20

PANTILO 28 PD, E27

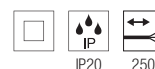
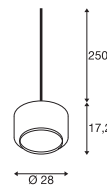

200-240V ~50/60Hz
Matière : verre

- Câble nu



Douille : 1xE27

Variante	Réf.	CHF
○ blanc	1006399	229.00
● or	1006397	249.00
● chrome	1003006	239.00
● cuivre	1003007	239.00



A60 | 7,5W | 180°
2700K | 720lm | CEE=F
8kWh / 1000h



Réf. : 1005305 | 24.50 CHF



Article	Réf.	CHF
Adaptateur 1 allumage		
● noir	143120	17.00
○ blanc	143121	17.00
● gris	143124	17.00
Adaptateur 3 allumages		
● noir	145990	24.50
● gris	145994	24.50
○ blanc	1001542	24.50
Fitu Patère 1 passe-fil		
○ blanc	132601	33.00
● or	1002163	35.20
FITU Patère 1 passe-fil, rond		
● noir	132600	33.00
● chrome	132605	35.20



1003443 283



PANTILO CONVEX 29
PD, E27

PANTILO CONVEX 40
PD, E27

1003444 283

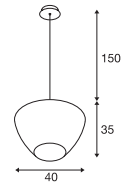
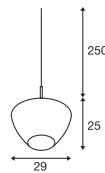

220-240V ~50/60Hz
Matière : verre / acier

220-240V ~50/60Hz
Matière : verre / acier

• Câble nu



Douille : E27 Ø max. : 10 cm L : 20 cm

Douille : E27 Ø max. : 15 cm L : 30 cm

Variante	Réf.	CHF
● chrome	1003443	279.00

Variante	Réf.	CHF
● chrome	1003444	390.00



A60 | 7,5W | 180°
2700K | 720lm | CEE=F
8kWh / 1000h



Réf. : 1005305 | 24.50 CHF



A60 | 7,5W | 180°
2700K | 720lm | CEE=F
8kWh / 1000h



Réf. : 1005305 | 24.50 CHF



Article	Réf.	CHF
Adaptateur 1 allumage		
● noir	143120	17.00
○ blanc	143121	17.00
● gris	143124	17.00
Adaptateur 3 allumages		
● noir	145990	24.50
● gris	145994	24.50
○ blanc	1001542	24.50
Fitu Patère 1 passe-fil		
○ blanc	132601	33.00
● or	1002163	35.20
FITU Patère 1 passe-fil, rond		
● noir	132600	33.00
● chrome	132605	35.20

1006438 285





ASTO TUBE

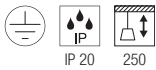

220-240V ~50/60Hz
Matière : aluminium



Douille : 1xGU10



LED GU10 51 mm | 6W | 36°
2200-2700K | 360lm | CEE=G
6kWh / 1000h



Réf. : 1005273 | 12.90 CHF

ASTO TUBE PD, simple, GU 10

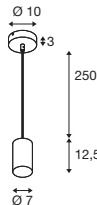

ASTO TUBE PD, double, GU 10

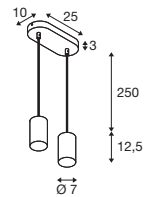

Variante	Réf.	CHF
● noir	1006431	74.90
○ blanc	1006432	74.90

Variante	Réf.	CHF
● noir	1006433	135.00
○ blanc	1006434	135.00

ASTO TUBE Réflecteur décoratif



H : 3,95 cm
Ø : 6,75 cm
Matière : polycarbonate (PC)

ASTO TUBE PD, triple, GU 10

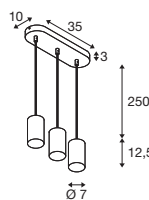

ASTO TUBE PD, quadruple, GU 10

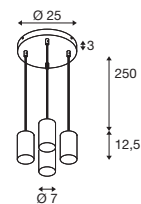

Variante	Réf.	CHF
● noir / chrome	1007190	5.20
● or	1006450	5.20
● chrome	1006449	5.20
● cuivre	1006451	5.20

Variante	Réf.	CHF
● noir	1006435	199.00
○ blanc	1006436	199.00

Variante	Réf.	CHF
● noir	1006437	240.00
○ blanc	1006438	240.00





WORKLIGHT PRO 120 PD, DALI

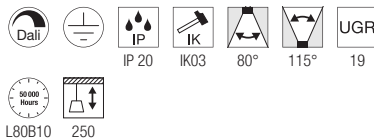
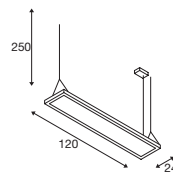

200-240V ~50/60Hz | 1200mA
Puissance totale : 50W
Matière : aluminium / acier



Up 2800lm | 4000K
Down 3300lm

Variante	Réf.	CHF
● noir	1007468	573.90
○ blanc	1007469	573.90
● gris	1007470	573.90

WORKLIGHT PRO 150 PD, DALI

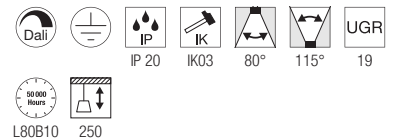
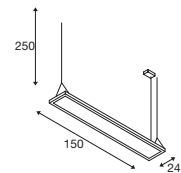

200-240V ~50/60Hz | 1400mA
Puissance totale : 59W
Matière : aluminium / acier



Up 3300lm | 4000K
Down 3900lm

Variante	Réf.	CHF
● noir	1007471	688.90
○ blanc	1007472	688.90
● gris	1007473	688.90

WORKLIGHT
PD, DALI



NEW

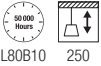
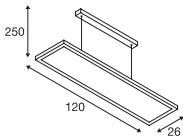

200-240V ~50/60Hz | 1550mA
Puissance totale : 57W
Matière : aluminium



Up 2000lm | 4000K
Down 3000lm

Variante	Réf.	CHF
● noir	1005395	775.00
○ blanc	1005396	775.00
● argent	1006345	709.00

1006345 288





I-PENDANT PRO
PD, 1195x295mm, DALI

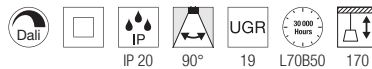
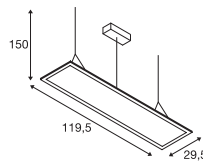

120-277V ~50/60Hz | 1000mA
Puissance totale : 43W
Matière : aluminium / polyméthacrylate de méthyle (PMMA)



Down 3750lm | 3000K
3800lm | 4000K

Variante	Réf.	CHF
○ blanc 3750lm 3000K	1003048	399.00
○ blanc 3800lm 4000K	1003049	399.00
● gris 3750lm 3000K	1003050	399.00
● gris 3800lm 4000K	1003051	399.00



PANEL 60
PD, rond, DALI

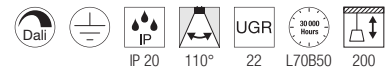
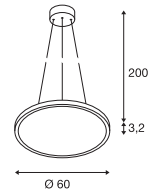

120-277V ~50/60Hz | 1000mA
Puissance totale : 43W
Matière : aluminium / polyméthacrylate de méthyle (PMMA)



Down 3150lm | 3000K
3350lm | 4000K

Variante	Réf.	CHF
○ blanc 3150lm 3000K	1003044	399.00
○ blanc 3350lm 4000K	1003045	399.00
● gris 3150lm 3000K	1003046	399.00
● gris 3350lm 4000K	1003047	399.00



NOYA
PD, PHASE

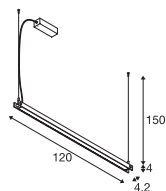

220-240V ~50/60Hz | 700mA
Puissance totale : 32W
Matériau : aluminium / polycarbonate (PC)



Down 1861lm | 2700K | 2025lm | 3000K

Variante	Réf.	CHF
● noir	1003530	520.00
○ blanc	1003532	520.00



1003530 290



1001403 291

GLENOS®
PD, 1m, 1-10V

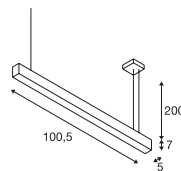

GLENOS®
PD, 2m, 1-10V

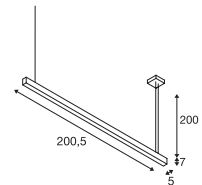

1001409 291

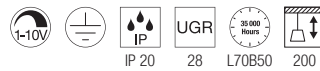

220-240V ~50/60Hz | 1000mA
Puissance totale : 43W
Matière : aluminium / plastique



Down 2850lm | 3000K
3300lm | 4000K

Variante	Réf.	CHF
● noir 2850lm 3000K	1001400	509.00
● noir 3300lm 4000K	1001403	509.00

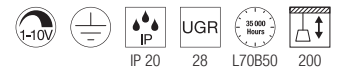

220-240V ~50/60Hz | 1000mA
Puissance totale : 85W
Matière : aluminium / plastique



Down 5700lm | 3000K
6600lm | 4000K

Variante	Réf.	CHF
● noir 5700lm 3000K	1001406	639.00
● noir 6600lm 4000K	1001409	639.00



1000933 293

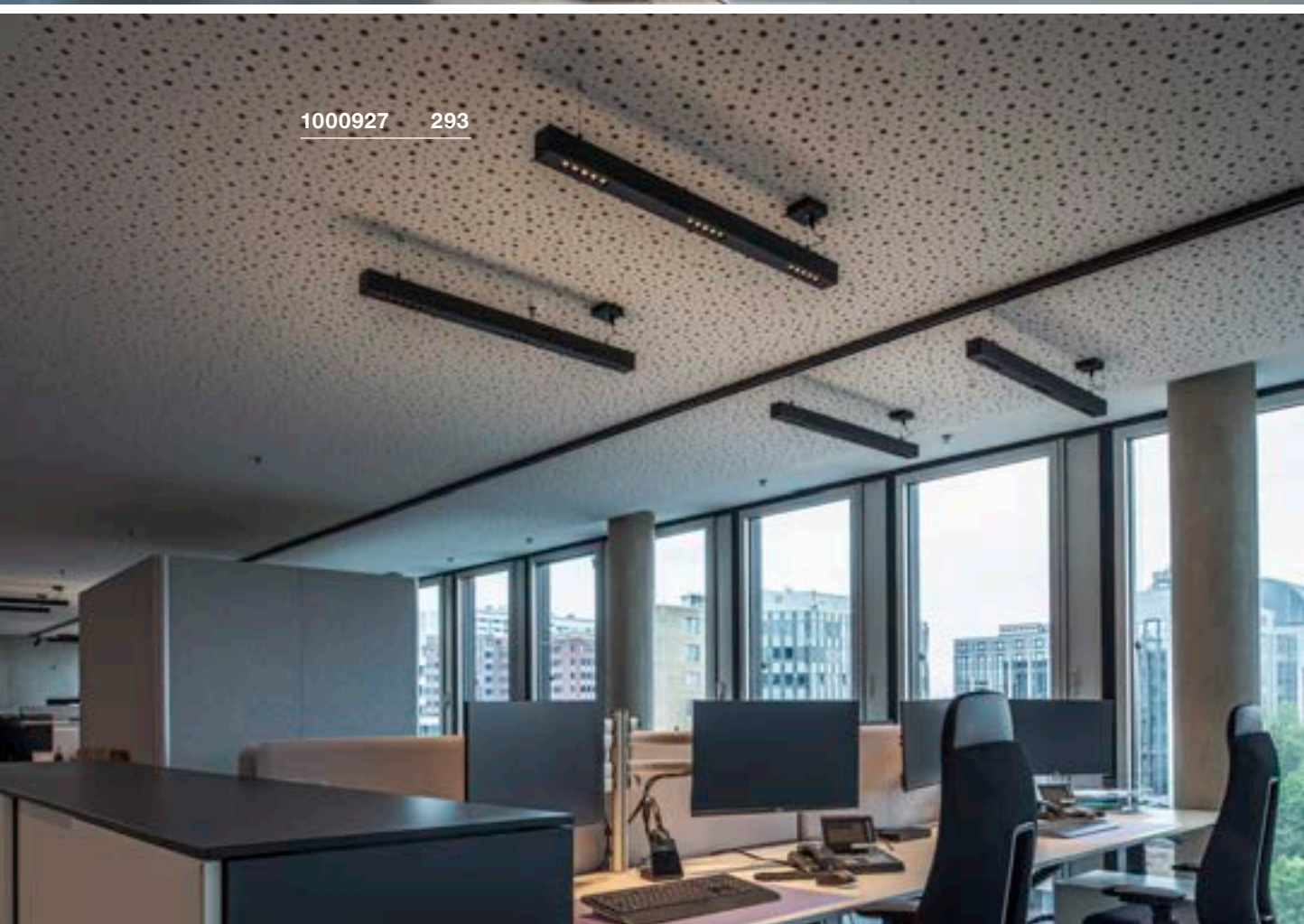

1000927 293



Q-LINE®
PD, 1m, BAP, PHASE

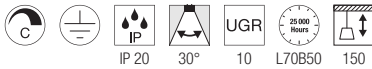
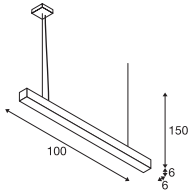

220-240V ~50/60Hz | 900mA
Puissance totale : 46W
Matière : aluminium / plastique



Down 2100lm | 3000K
2300lm | 4000K

Variante	Réf.	CHF
● noir 2100lm 3000K	1000927	599.00
● noir 2300lm 4000K	1000933	599.00
○ blanc 2100lm 3000K	1000926	599.00
○ blanc 2300lm 4000K	1000932	599.00

Q-LINE®
PD, 2m, BAP, PHASE

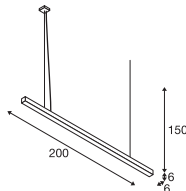

220-240V ~50/60Hz | 900mA
Puissance totale : 93W
Matière : aluminium / plastique



Down 4200lm | 3000K
4600lm | 4000K

Variante	Réf.	CHF
● noir 4200lm 3000K	1000930	869.00
● noir 4600lm 4000K	1000936	869.00
○ blanc 4200lm 3000K	1000929	869.00
○ blanc 4600lm 4000K	1000935	869.00

Q-LINE®
PD, DALI, simple

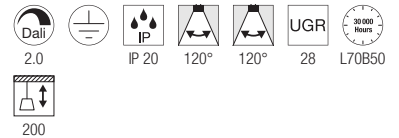
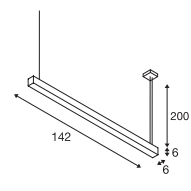

220-240V ~50/60Hz | 700mA
Puissance totale : 47W
Matière : aluminium / acrylique



Down 3700lm | 3000K

Variante	Réf.	CHF
● noir	1001309	689.00
○ blanc	1001310	689.00

OCULUS
PD, simple, PHASE

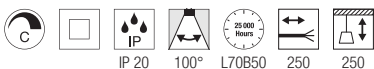
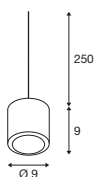

220-240V ~50/60Hz | 250mA
Puissance totale : 11W
Matière : aluminium / verre

- Réflecteur dépoli supplémentaire inclus
- Accessoires compatibles disponibles en page 295
- Câble nu



Down 36lm | 2000K - 780lm | 3000K

Variante	Réf.	CHF
● noir	1004672	279.00
○ blanc	1004673	279.00

1004672 294



132690 295





FITU
PD, E27

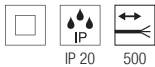
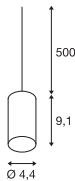

220-240V ~50/60Hz
Matière : aluminium

- Câble textile
- Accessoires compatibles disponibles en page 295
- Câble nu



Douille : 1xE27

Variante	Réf.	CHF
● noir	132690	74.00
○ blanc	132691	74.00



A60 | 7,5W | 320°
2700K | 800lm | CEE=F
8kWh / 1000h



Réf. : 1005303 | 12.90 CHF

Fitu Patère 1 passe-fil, rond

16 A max.
Acier
H : 3,9 cm
Ø : 8,5 cm
Avec serre-câble



Variante	Réf.	CHF
● noir	132600	33.00
○ blanc	132601	33.00
● or	1002163	35.20
● chrome	132605	35.20

FITU Patère 3 passe-fils, rond

16 A max.
Acier
H : 5,4 cm
Ø : 22 cm
Avec serre-câble



Variante	Réf.	CHF
● noir	132610	79.00
○ blanc	132611	79.00

Patère en saillie

16 A max.
Acier
H : 2,6 cm
Ø : 9 cm



Variante	Réf.	CHF
● noir	1004744	42.65
○ blanc	1004745	42.65
● or	1006377	49.10
● chrome	1004746	49.10

Patère encastrable

16 A max.
Acier / polyamide 66 (PA 66)
H : 3,3 cm
Ø : 8,5 cm



Variante	Réf.	CHF
● noir	1004674	27.70
○ blanc	1004675	27.70
● or	1006378	33.00
● chrome	1004676	33.00

Crochet de plafond

Aluminium
L : 4,6 cm
Ø : 1,8 cm



Variante	Réf.	CHF
● noir	132670	24.50
○ blanc	132671	24.50

Adaptateur 1 allumage

6 A max.
Polycarbonate (PC)
L : 8,5 cm l : 3,5 cm H : 3,2 cm
Charge mécanique max. 2 kg



Variante	Réf.	CHF
● noir	143120	17.00
○ blanc	143121	17.00
● gris	143124	17.00

Adaptateur 3 allumages

10 A max.
Plastique
L : 9,6 cm l : 3,5 cm H : 4,5 cm
Charge mécanique max. 5 kg



Variante	Réf.	CHF
● noir	145990	24.50
○ blanc	1001542	24.50
● gris	145994	24.50

Crochet pour câble

Aluminium
L : 3,1 cm
Ø : 1,4 cm



Variante	Réf.	CHF
● noir	132680	17.00
○ blanc	132681	17.00

FENDA
PD, E27



FENDA
Abat-jour en verre



H : 20 cm
Ø : 12,5 cm
Matière : verre

FENDA
15 cm, rond



H : 40 cm
Ø : 15 cm
Matière : textile / acier

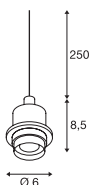

Variante	Réf.	CHF
● fumé	1000773	85.00

Variante	Réf.	CHF
● noir / cuivre	156152	64.00
○ blanc	156141	55.00
● gris	1004773	55.00
● beige	156143	55.00

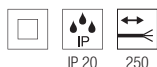

220-240V ~50/60Hz
Matière : acier / plastique

- Accessoires compatibles disponibles en page 295
- Câble nu



Douille : 1xE27

Variante	Réf.	CHF
● noir	132660	35.20
○ blanc	132661	35.20
● chrome	132662	41.60



A60 | 7,5W | 320°
2700K | 800lm | CEE=F
8kWh / 1000h



Réf. : 1005303 | 12.90 CHF

155560 + 1000773 296





FENDA
30 cm, rond



H : 20 cm
Ø : 30 cm
Matière : textile / acier

FENDA
Ø 45 cm, rond



H : 28 cm
Ø : 45,5 cm
Matière : textile / acier

FENDA
Ø 70 cm, rond



H : 36 cm
Ø : 70 cm
Matière : textile / acier

• Non compatible avec Fenda Bow.

Variante	Réf.	CHF
●● noir / cuivre	155592	85.00
○ blanc	155582	64.00
● gris	1004774	64.00
● beige	155583	64.00

Variante	Réf.	CHF
●● noir / cuivre	156122	117.00
○ blanc	156111	102.00
● gris	1004775	102.00
● beige	156113	102.00

Variante	Réf.	CHF
●● noir / cuivre	1000580	156.00
○ blanc	1000579	138.00



Article	Réf.	CHF
Diffuseur en verre acrylique	156100	55.00



Article	Réf.	CHF
Diffuseur en verre acrylique	1000957	117.00



155561 + 1000579 296 + 297

MIX & MATCH FENDA

FENDA Ø15

Noir	156152
Blanc	156141
Beige	156143
Gris	1004773



FENDA Ø30

Noir	155592
Blanc	155582
Beige	155583
Gris	1004774



FENDA Ø45

Noir	156122
Blanc	156111
Beige	156113
Gris	1004775

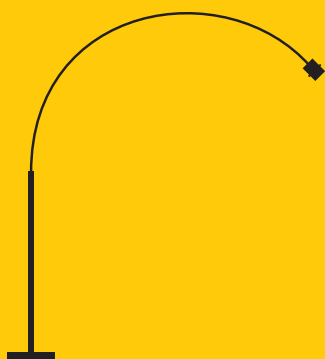

FENDA BOW

Noir	1003029
Chrome	1000763



FENDA TL

Noir	155780
------	--------



FENDA FL

Noir	155790
------	--------



FENDA TL

Noir	155540
------	--------

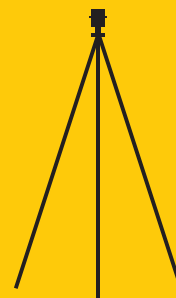

FENDA FL

Noir	155490
------	--------

Combinez les produits SLV Mix & Match selon vos envies. Parfaitement assortis, vous pouvez les choisir au sein de la famille FENDA mais aussi mélanger les familles FENDA et FITU ensemble. Vous pouvez identifier les produits SLV Mix & Match à l'aide du symbole suivant :



MIX
match

FENDA Ø70

Noir | 1000580
Blanc | 1000579

FENDA Ø12,5

Glass Shade

Fumé | 1000773



FITU CRAN BASE est
aussi compatible avec
la FENDA PD et les
abat-jour FENDA

FENDA PD

Noir | 132660
Blanc | 132661
Chrome | 132662

FENDA CL

Noir | 155550
Blanc | 155551

FITU CRANE BASE

Noir | 1004682



FITU PD

Noir | 132690
Blanc | 132691

HELIA AMBIENT 35 PD, PHASE

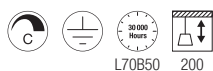
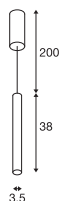
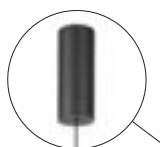

L70B50 200

220-240V ~50/60Hz | 500mA
Puissance totale : 9W
Matière : aluminium / acrylique



Down 425lm | 3000K

Variante	Réf.	CHF
● noir	1003436	279.00

HELIA AMBIENT 35 PD

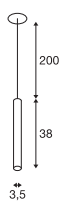

L70B50 200

500mA
Puissance totale : 7,5W
Matière : aluminium / acrylique

- Câble nu
- Ø patère encastrable : 68 mm



Down 425lm | 3000K

Variante	Réf.	CHF
● noir	1003435	219.00



Article	Réf.	CHF
Driver LED 20W 350mA/500mA PHASE		
○ blanc	1007227	46.00
Driver LED 25W 150-700mA variable DALI		
○ blanc	1007229	80.50
Driver LED 21W 500 mA, avec serre-câble		
○ blanc	1007226	34.50

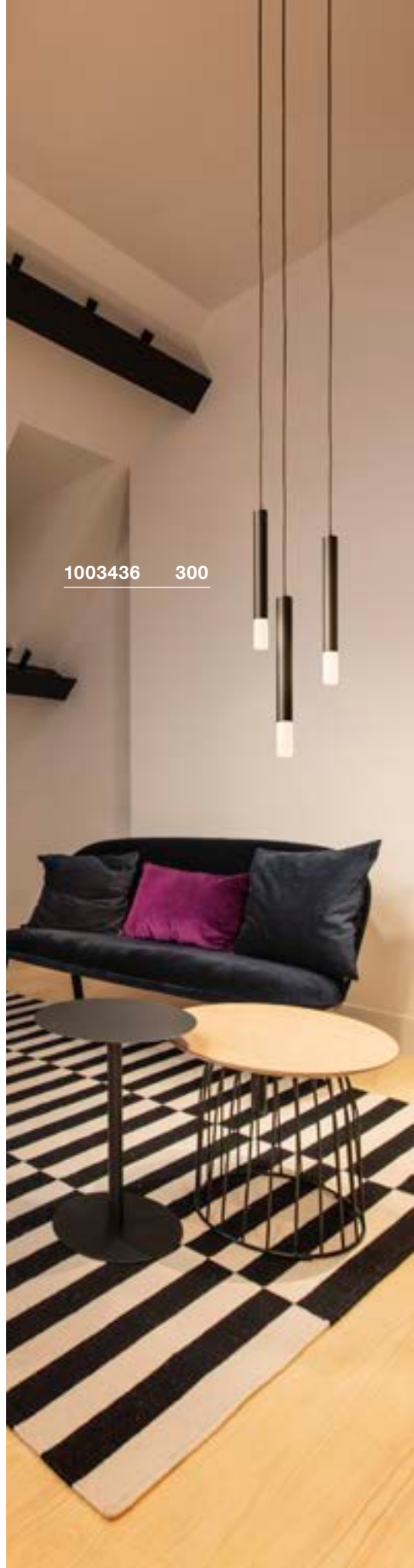

1003436 300



HELIA 30 PD, PHASE

HELIA 30 PD

152360 301

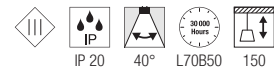
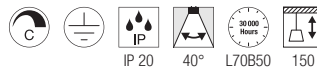
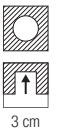
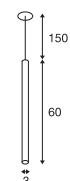
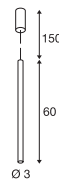

220-240V ~50/60Hz | 500mA
Puissance totale : 9,2W
Matière : aluminium

500mA
Puissance totale : 7,5W
Matière : aluminium

- Patère encastrable fournie
- Épaisseur du support de montage : 12mm max.
- Ø patère encastrable : 68 mm



Down 590lm | 3000K



Down 500lm | 3000K

Variante	Réf.	CHF
● noir	152360	269.00

Variante	Réf.	CHF
● noir	158400	219.00



Article	Réf.	CHF
Driver LED 20W 350mA/500mA PHASE		
○ blanc	1007227	46.00
Driver LED 25W 150-700mA variable DALI		
○ blanc	1007229	80.50
Driver LED 21W 500 mA, avec serre-câble		
○ blanc	1007226	34.50

152370 303





HELIA 40 PD, PHASE

HELIA 40 PD

158400 303

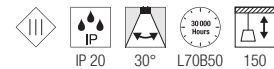
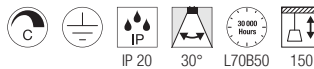
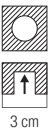
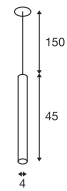
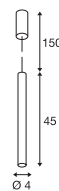

220-240V ~50/60Hz | 500mA
Puissance totale : 10W
Matière : aluminium

500mA
Puissance totale : 9W
Matière : aluminium

- Patère encastrable fournie
- Épaisseur du support de montage : 12mm max.
- Ø patère encastrable : 68 mm



Down 730lm | 3000K



Down 700lm | 3000K

Coloris	Réf.	CHF
● noir	152370	309.00

Variante	Réf.	CHF
● noir	158410	259.00



Article	Réf.	CHF
Driver LED 20W 350mA/500mA PHASE		
○ blanc	1007227	● 46.00
Driver LED 25W 150-700mA variable DALI		
○ blanc	1007229	● 80.50
Driver LED 21W 500 mA, avec serre-câble		
○ blanc	1007226	● 34.50



149388 305



ASTINA PD, QPAR51

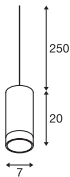

220-240V ~50/60Hz
Matière : aluminium

- Câble nu



Douille : 1xGU10

Variété	Ref.	CHF
● noir	1002939	138.00
○ blanc	1002937	138.00



LED GU10 51 mm | 6W | 36°
2200-2700K | 360lm | CEE=G
6kWh / 1000h



Réf. : 1005273 | 12.90 CHF

ENOLA B PD, QPAR51

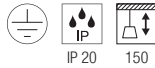
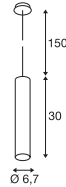

220-240V ~50/60Hz
Matière : aluminium / acier



Douille : 1xGU10

Variante	Réf.	CHF
● noir	151850	138.00
○ blanc	151851	138.00
● or	151853	156.00



LED GU10 51 mm | 6W | 38°
2700K | 450lm | CEE=F
6kWh / 1000h



Réf. : 1005077 | 10.60 CHF

ENOLA PD, E27

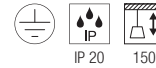
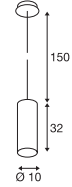
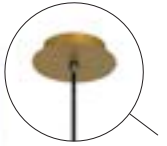

220-240V ~50/60Hz
Matière : aluminium / acier



Douille : 1xE27

Ø max. : 9 cm | L : 18 cm

Variante	Réf.	CHF
● noir	149388	117.00
○ blanc	149381	117.00
● or	149387	128.00



LED E27 | 13,2W | 220°
2700K | 1300lm | CEE=F
13kWh / 1000h



Réf. : 1005302 | 17.00 CHF



Article	Réf.	CHF
Adaptateur 1 allumage		
● noir	143120	17.00
○ blanc	143121	17.00
● gris	143124	17.00
Adaptateur 3 allumages		
● noir	145990	24.50
● gris	145994	24.50
○ blanc	1001542	24.50
Fitu Patère 1 passe-fil, rond		
● noir	132600	33.00
● chrome	132605	35.20
Fitu Patère 1 passe-fil		
○ blanc	132601	33.00
FITU Patère 3 passe-fils, rond		
● noir	132610	79.00
○ blanc	132611	79.00

ANELA
PD, PHASE



LISENNE
PD, E27

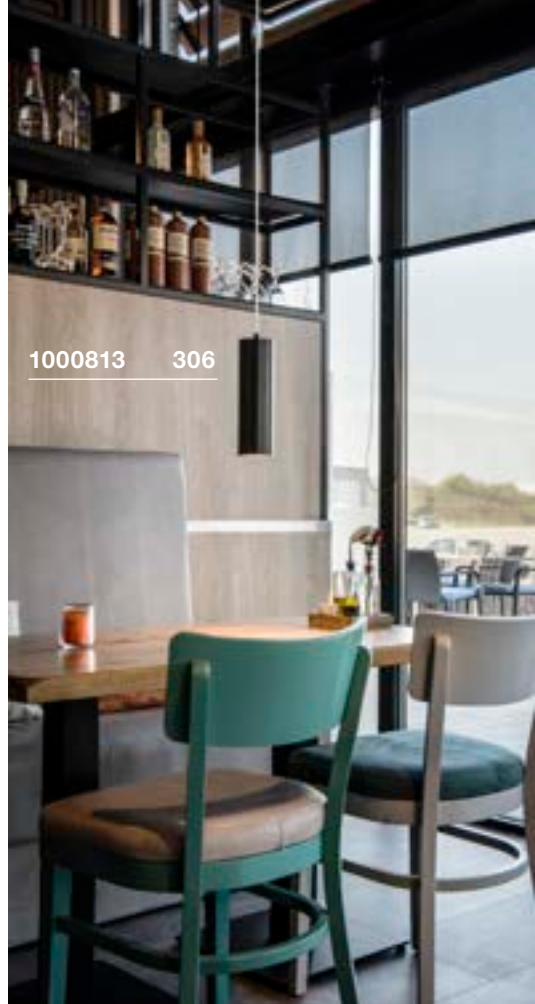

1000813 306



155714 306

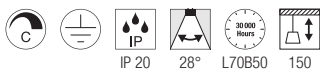

220-240V ~50/60Hz | 500mA
Puissance totale : 10W
Matière : aluminium

- Réflecteur non fourni
- Flux lumineux avec réflecteur 1000809 = 500 lm /
Flux lumineux avec réflecteur 1000810 = 620 lm /
Flux lumineux avec réflecteur 1000811 = 200 lm /
Flux lumineux avec réflecteur 1000812 = 600 lm



Down 220lm | 3000K 750lm |

Variante	Réf.	CHF
● noir	1000813	249.00



Article	Réf.	CHF
Réflecteur 28°		
● noir	1000811	24.50
○ blanc	1000812	24.50
● or	1000809	24.50
● gris	1000810	24.50

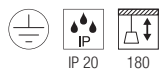

220-240V ~50/60Hz
Matière : basalte / verre



Douille : 1xE27 Ø max. : 5,9 cm L : 15 cm

Variante	Réf.	CHF
● gris / fumé	155714	289.00



LED E27 | 8W | 240°
3000K | 880lm | CEE=E
8kWh / 1000h
Réf. : 1005289 | 12.90 CHF





133444 307

TONGA®
PD, E14

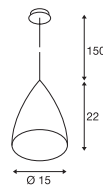

220-240V ~50/60Hz
Matière : aluminium / verre



Douille : 1xE14 Ø max. : 5,1 cm L : 13 cm

Variante	Réf.	CHF
● gris	133444	149.00



C35 | 4,2W | 320°
2700K | 350lm | CEE=G
5kWh / 1000h



Réf. : 1005285 | 12.90 CHF

QUADRASS
PD, E27

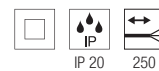
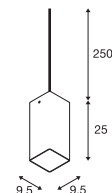

220-240V ~50/60Hz
Matière : acier / verre

- Câble nu



Douille : 1xE27 Ø max. : 6,5 cm L : 18 cm

Variante	Réf.	CHF
● chrome	1003432	124.00



LED E27 | 13,2W | 220°
2700K | 1300lm | CEE=F
13kWh / 1000h



Réf. : 1005302 | 17.00 CHF



Article	Réf.	CHF
Adaptateur 1 allumage		
○ blanc	143121	17.00
Adaptateur 3 allumages		
○ blanc	1001542	24.50
Fitu Patère 1 passe-fil		
○ blanc	132601	33.00

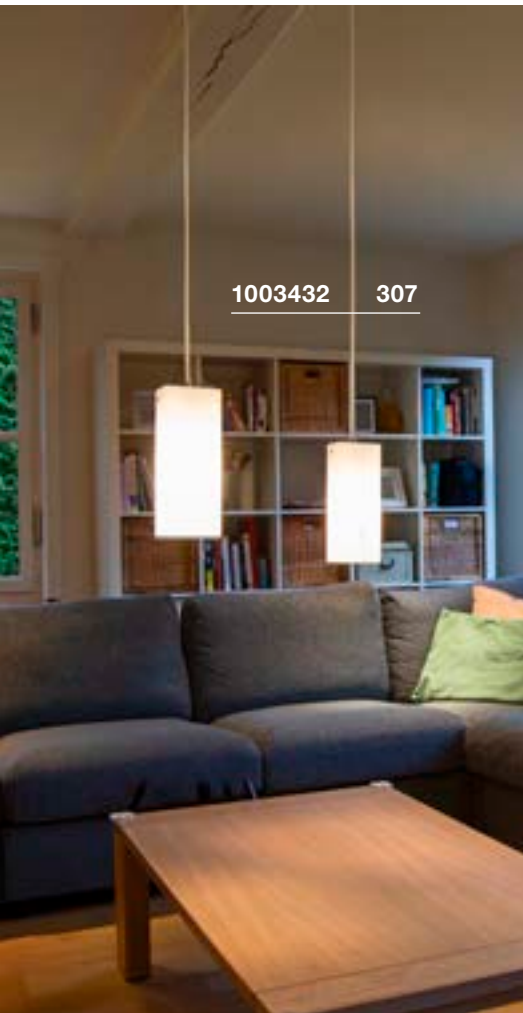

1003432 307



1006159 309



133019 309

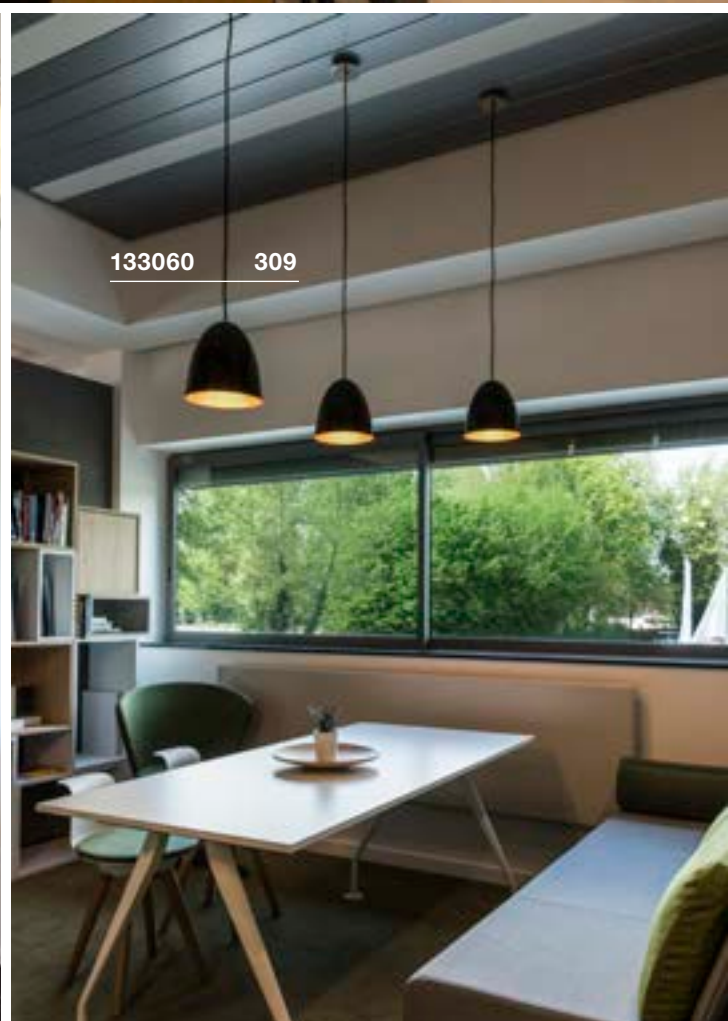

133060 309



PARA CONE GL PD, GU10

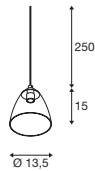

220-240V ~50/60Hz
Matière : aluminium / verre

- Câble nu



Douille : 1xGU10

Variante	Réf.	CHF
● noir	1006159	109.00
○ blanc	1006160	109.00



LED GU10 51 mm | 6W | 38°
2700K | 450lm | CEE=F
6kWh / 1000h



Réf. : 1005077 | 10.60 CHF

PARA CONE 20 PD, E27

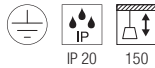
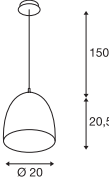

220-240V ~50/60Hz
Matière : aluminium / acier

- Câble textile
- Version noir/or avec réflecteur doré
- Toutes les autres versions ont le réflecteur blanc



Douille : 1xE27

Variante	Réf.	CHF
● or / noir	133050	160.00
● cuivre	133009	202.00



A60 | 7,5W | 32°
2700K | 800lm | CEE=F
8kWh / 1000h



Réf. : 1005303 | 12.90 CHF

PARA CONE 30 PD, E27

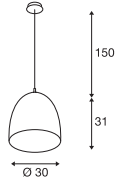

220-240V ~50/60Hz
Matière : aluminium / acier

- Câble textile
- Version noir/or avec réflecteur doré
- Toutes les autres versions ont le réflecteur blanc



Douille : 1xE27

Variante	Réf.	CHF
● noir / or	133060	219.00
● cuivre	133019	249.00



A60 | 7,5W | 32°
2700K | 800lm | CEE=F
8kWh / 1000h



Réf. : 1005303 | 12.90 CHF



Article	Réf.	CHF
Adaptateur 1 allumage		
● noir	143120	17.00
○ blanc	143121	17.00
● gris	143124	17.00
Adaptateur 3 allumages		
● noir	145990	24.50
● gris	145994	24.50
○ blanc	1001542	24.50
Patère en saillie		
● noir	1004744	42.65
○ blanc	1004745	42.65
● chrome	1004746	49.10
Patère encastrable		
● noir	1004674	27.70
○ blanc	1004675	27.70
Fitu Patère 1 passe-fil, rond		
● noir	132600	33.00
● chrome	132605	35.20
Fitu Patère 1 passe-fil		
○ blanc	132601	33.00



1002949 311

1002951 310

1002950 311



1002949 311

PHELIA 10 PD, E27

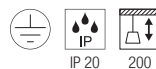
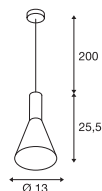

220-240V ~50/60Hz
Matière : aluminium

- Câble textile

**SOCKET
INSIDE** <23
W

Douille : 1xE27

Variante	Réf.	CHF
● noir / or	1002951	169.00



A60 | 7,5W | 180°
2700K | 720lm | CEE=F
8kWh / 1000h



Réf. : 1005305 | 24.50 CHF



PHELIA 20
PD, E27

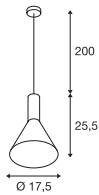

220-240V ~50/60Hz
Matière : aluminium

- Câble textile



Douille : 1xE27

Variante	Réf.	CHF
●● noir / or	1002948	185.00



LED E27 | 13,2W | 220°
2700K | 1300lm | CEE=F
13kWh / 1000h



Réf. : 1005302 | 17.00 CHF

PHELIA 25
PD, E27

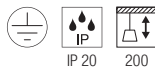
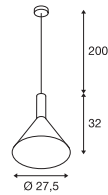

220-240V ~50/60Hz
Matière : aluminium

- Câble textile



Douille : 1xE27

Variante	Réf.	CHF
●● noir / or	1002949	209.00



LED E27 | 13,2W | 220°
2700K | 1300lm | CEE=F
13kWh / 1000h



Réf. : 1005302 | 17.00 CHF

PHELIA 30
PD, E27

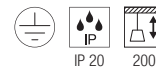
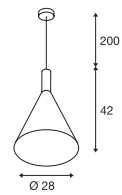

220-240V ~50/60Hz
Matière : aluminium

- Câble textile



Douille : 1xE27

Variante	Réf.	CHF
●● noir / or	1002950	239.00



G125 | 7,5W | 320°
2700K | 800 lm
CEE=F 8 kWh/1000 h



Réf. : 1005310 | 27.70 CHF

FORCHINI 50
PD, E27

FORCHINI 70
PD, E27

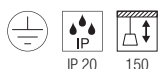
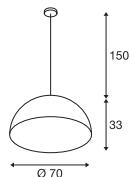
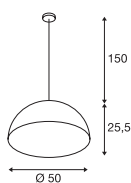

220-240V ~50/60Hz
Matière : PRV

- Câble textile



Douille : 1xE27 L max. : 20 cm

Variante	Réf.	CHF
● noir / or	155530	259.00

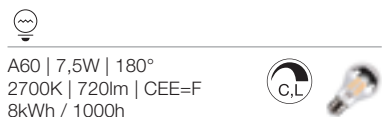

Réf. : 1005305 | 24.50 CHF

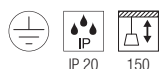

220-240V ~50/60Hz
Matière : PRV

- Câble textile



Douille : 1xE27 L max. : 20 cm

Variante	Réf.	CHF
● noir / or	1001701	469.00



Réf. : 1005302 | 17.00 CHF

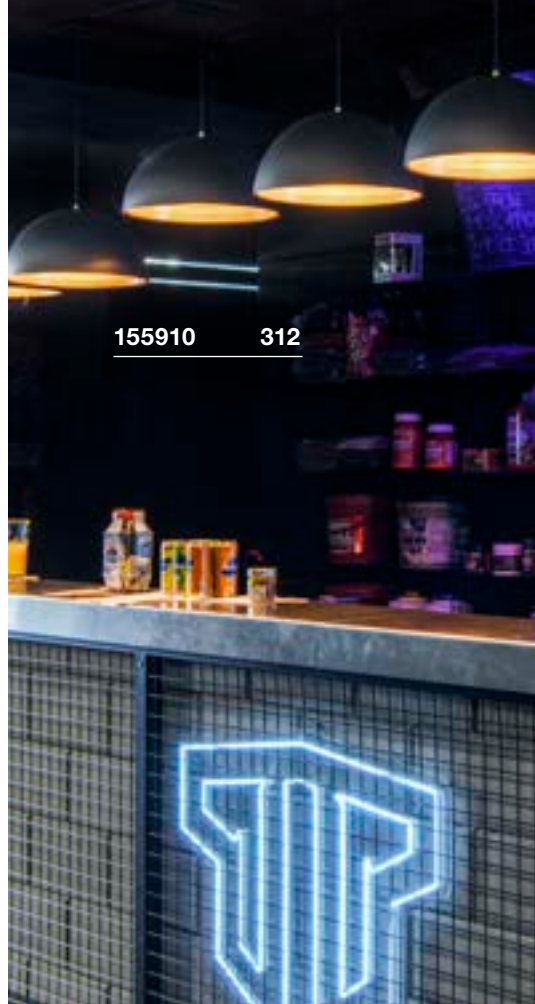

155910 312



1001701 311



FORCHINI M 40
PD, E27

FORCHINI M 50
PD, E27

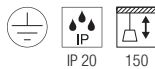
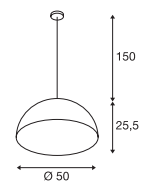
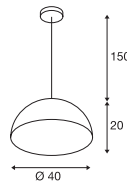

220-240V ~50/60Hz
Matière : aluminium / acier

220-240V ~50/60Hz
Matière : aluminium / acier

- Câble textile

- Câble textile



Douille : 1xE27

L max. : 15,2 cm

Douille : 1xE27

L max. : 18 cm

Variante	Réf.	CHF
● noir / or	155910	249.00

Variante	Réf.	CHF
● noir / or	155930	289.00



A60 | 7,5W | 180°
2700K | 720lm | CEE=F
8kWh / 1000h



Réf. : 1005305 | 24.50 CHF



LED E27 | 13,2W | 220°
2700K | 1300lm | CEE=F
13kWh / 1000h



Réf. : 1005302 | 17.00 CHF

LIGHT EYE® 90
PD, GU10

LIGHT EYE® 150
PD, QPAR111

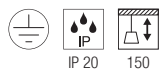
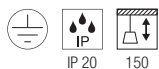
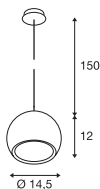
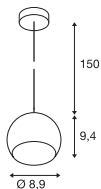

220-240V ~50/60Hz
Matière : acier

220-240V ~50/60Hz
Matière : acier

- Câble textile

- Câble textile



Douille : 1xGU10

Douille : 1xGU10

Variante	Réf.	CHF
● noir / chrome	133490	102.00

Variante	Réf.	CHF
○ blanc / chrome	133481	138.00
● chrome	133482	149.00
● cuivre	133489	185.00



Réf. : 1005311 | 44.90 CHF



Réf. : 1005276 | 62.00 CHF

Article	Réf.	CHF
Anneau décoratif pour source Ø 5,7 cm		
● noir	151040	7.90
○ blanc	151041	7.90
● chrome	151049	11.90

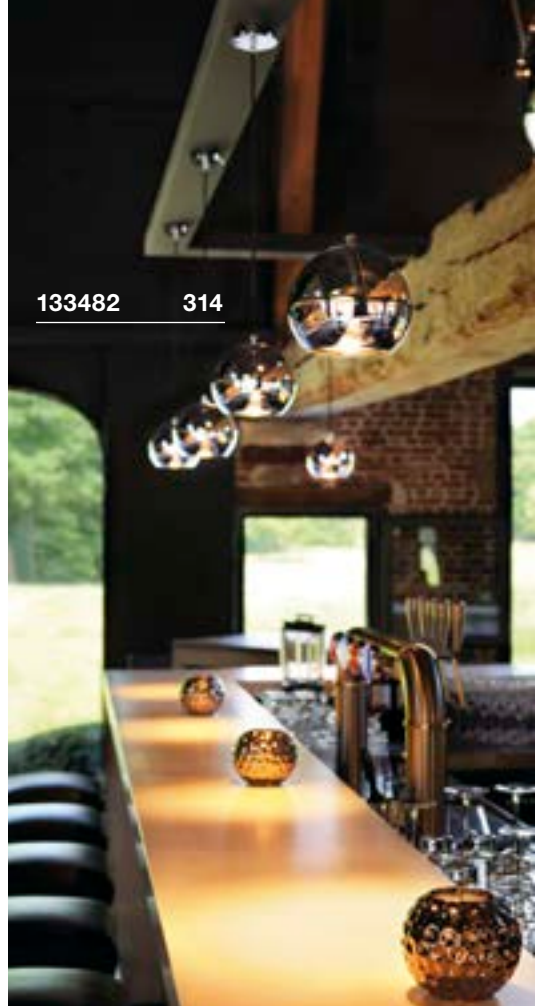

133482 314



133481 314



SUN / BIG SUN
PD, E27

1002045 315

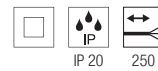
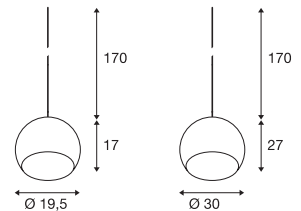

220-240V ~50/60Hz
Matière : acier / verre

- Accessoires compatibles disponibles en page 295
- Câble nu

SOCKET INSIDE <60 W

Douille : 1xE27 Ø max. : 7 cm L : 12 cm

Variante	Réf.	CHF
○ 1xE27 Ø : 19,5 cm	1002045	117.00
○ 1xE27 Ø : 30 cm	1002046	209.00



A60 | 7,5W | 320°
2700K | 800lm | CEE=F
8kWh / 1000h



Réf. : **1005303** | **12.90 CHF**



165410 317



165400 317

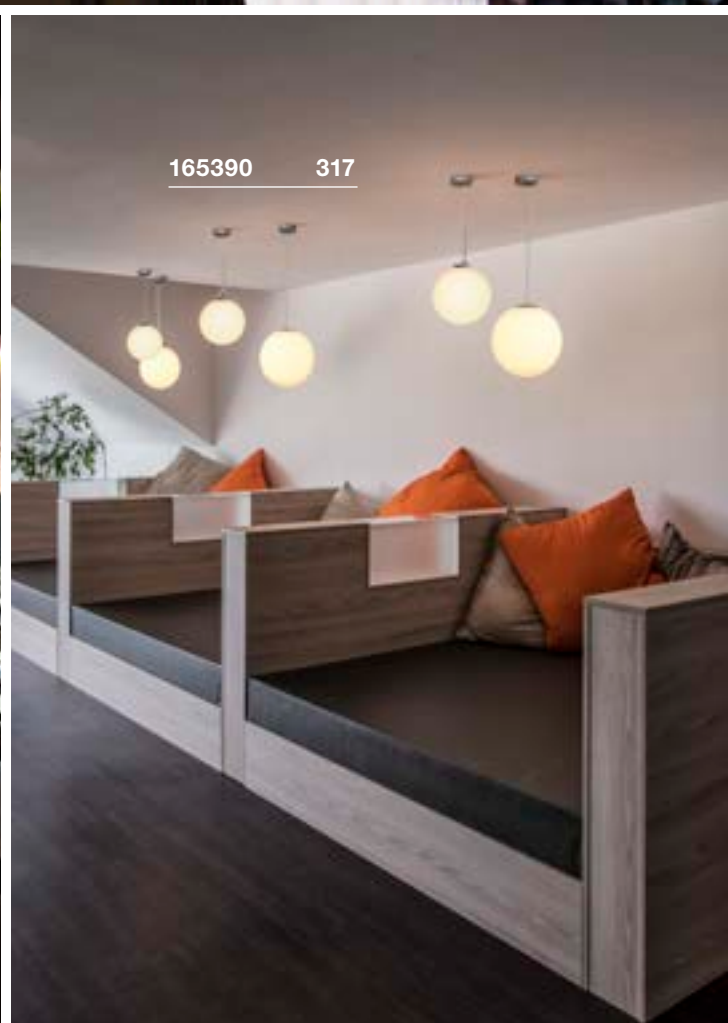

165390 317



ROTOBALL 25
PD, E27

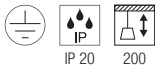

220-240V ~50/60Hz
Matière : acier / polyéthylène (PE)



Douille : 1xE27 Ø max. : 7 cm

Variante	Réf.	CHF
○ blanc	165390	202.00



LED E27 | 13,2W | 220°
2700K | 1300lm | CEE=F
13kWh / 1000h



Réf. : 1005302 | 17.00 CHF

ROTOBALL 40
PD, E27

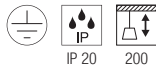

220-240V ~50/60Hz
Matière : acier / polyéthylène (PE)



Douille : 1xE27 Ø max. : 9,5 cm

Variante	Réf.	CHF
○ blanc	165410	219.00



LED E27 | 13,2W | 220°
2700K | 1300lm | CEE=F
13kWh / 1000h



Réf. : 1005302 | 17.00 CHF

ROTOBALL 50
PD, E27

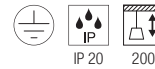
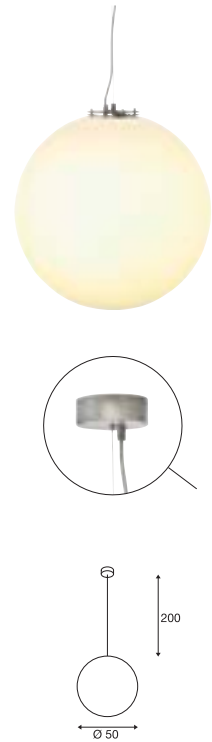

220-240V ~50/60Hz
Matière : acier / polyéthylène (PE)



Douille : 1xE27 Ø max. : 9,5 cm

Variante	Réf.	CHF
○ blanc	165400	279.00



LED E27 | 13,2W | 220°
2700K | 1300lm | CEE=F
13kWh / 1000h



Réf. : 1005302 | 17.00 CHF

PARA DOME PD, E27

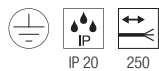
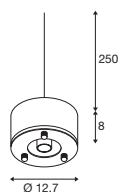

220-240V ~50/60Hz
Matière : aluminium

- Câble nu

**SOCKET
INSIDE** <150
W

Douille : 1xE27 Ø max. : 7 cm

Variante	Réf.	CHF
● noir	1005214	99.00
● gris	1005215	99.00

LED E27 | 13.2W | 220°
2700K | 1300lm | CEE=F
13kWh / 1000h

Réf. : 1005302 | 17.00 CHF

Article	Réf.	CHF
Adaptateur 1 allumage		
● noir	143120	17.00
Adaptateur 3 allumages		
● noir	145990	24.50
Patère en saillie		
● noir	1004744	42.65
Patère		
● noir	210060	41.60
Fitu Patère 1 passe-fil, rond		
● noir	132600	33.00

PARA DOME Abat-jour



NEW



H : 20,6 cm
Ø : 30,8 cm
Matière : aluminium

Variante	Réf.	CHF
● noir	1005216	132.00
● noir / or	1006410	118.00
● gris	1005217	132.00

PARA DOME Abat-jour



H : 20 cm
Ø : 31,5 cm
Matière : polycarbonate (PC)

Variante	Réf.	CHF
○ transparent	1005218	132.00



165358 319



165359 319



PARA 380

PD, E27

165359

319

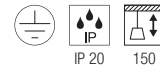
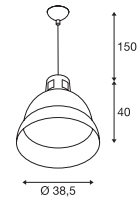

220-240V ~50/60Hz
Matière : aluminium

SOCKET 
INSIDE <20 W

Douille : 1xE27

Variante	Réf.	CHF
● noir	165359	202.00
● aluminium	165358	202.00



LED E27 | 13,2W | 220°
2700K | 1300lm | CEE=F
13kWh / 1000h



Réf. : 1005302 | 17.00 CHF

1007612 325





LED
LYGANT | 325



LED
LYGANT | 325



SOCKET
VARYT | 327



LED
SEDO 7 | 329



LED
SEDO 14 | 329



LED
SEDO 21 | 329



LED
TRUKKO | 330



LED
TRUKKO | 330



LED
TRUKKO | 331



LED
TRUKKO 80 | 331



LED
TRUKKO 60 | 332



LED
TRUKKO 90 | 332



LED
MARYLIN 40 | 333



LED
WL 149 | 334



SOCKET
WL 149 | 334



SOCKET
WL 106 | 335



SOCKET
WL 106 | 335



SOCKET
MIBO UP/DOWN | 337



LED
MAGANDA | 337



LED
DORISA 30 | 339



LED
DORISA 50 | 339



LED
GLENOS® 60 | 339



LED
L-LINE 60 | 341



LED
L-LINE 120 | 341



LED
Q-LINE® | 341

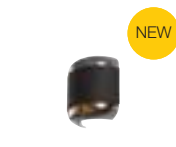

SOCKET
PANTILO ROPE | 345

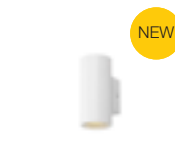

SOCKET
ASTO TUBE | 347



SOCKET
ASTO TUBE | 347



LED
MANA BASE | 349



LED
MANA BASE | 349



LED
MANA 40 | 319



LED
MANA 60 | 349



LED
MANA | 351



LED
MANA | 351



LED
MANA | 351



LED
MANA | 353



LED
MANA | 353



LED
MANA | 353



LED
MANA | 353



LED
OCULUS | 355



LED
OCULUS
UP/DOWN | 355



SOCKET
PLASTRA | 356



SCKET
PLASTRA | 356



SCKET
PLASTRA | 357



SCKET
PLASTRA | 357



SCKET
PLASTRA | 359



LED
PLASTRA | 359



LED
PLASTRA | 359



SCKET
PLASTRA | 360



SCKET
PLASTRA 101 | 361



SCKET
PLASTRA | 361



SCKET
PLASTRA 104 | 361



LED
LOGS IN | 362



LED
LOGS IN | 362



LED
LOGS IN L | 363



LED
LOGS IN L | 363



LED
QUAD FRAME 14 | 364



LED
QUAD FRAME 19 | 364



LED
SHELL 15 | 365



LED
SHELL 30 | 365

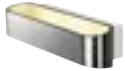

LED
ASSO 300 | 366



LED
ASSO 300 | 367



SCKET
OSSA 180 | 367



SCKET
OSSA 300 | 367



LED
CARISO | 368



LED
CARISO | 368



LED
CHROMBO | 369



LED
DIRETO 60 | 370



LED
DIRETO 90 | 370



LED
ARLINA 60 | 371



LED
ARLINA 130 | 371



SCKET
ANDREAS | 373



SCKET
DENA 30 | 373



SCKET
BASKET | 373



SCKET
QUADRASS | 375



LED
QUADRASS
SPOT | 375



SCKET
LISENNE | 375



SCKET
FITU | 376



SCKET
FITU CUBE | 376



SCKET
THEO UP/DOWN | 377



SCKET
SOLID CUBE | 377



ENOLA B | 379



ENOLA B | 379



**ASTINA
UP/DOWN** | 379



SCKET
FENDA | 380



FENDA | 380



LED
KENKUA SPOT | 381



LED
COUPA FLEX | 381



LED
KARPO MAGN | 382



LED
KARPO GOOSE | 382



LED
KARPO 30 | 383



LED
KARPO | 383



LED
SOMNILA SPOT | 384



LED
SOMNILA SPOT | 385



LED
SOMNILA FLEX | 385



LED
SOMNILA FLEX | 385



SCKET
DIO FLEX PLATE | 387



LED
DIO FLEX PLATE | 387



LED
DIO FLEX PLATE | 387



SCKET
PHELIA | 388



LED
MERADO FLOOD | 388



SCKET
DISPLAY ADL 50 | 389

1007619 325





LYGANT WL, simple

LYGANT WL, double

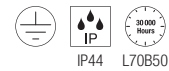
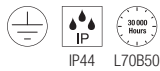
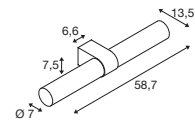
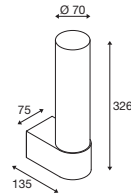

220-240V ~50/60Hz | 700mA
Puissance totale : 8W
Matière : acier inoxydable / verre

220-240V ~50/60Hz | 500mA
Puissance totale : 11W
Matière : acier inoxydable / verre



Down 560lm | 3000K

Down 800lm | 3000K

Variante	Réf.	CHF
● noir	1007614	286.40
○ blanc	1007613	286.40
● laiton	1007612	320.90
● chrome	1007615	320.90

Variante	Réf.	CHF
● noir	1007618	412.90
○ blanc	1007617	412.90
● laiton	1007616	442.80
● chrome	1007619	442.80

1007603 327

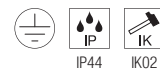
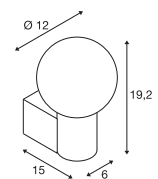

VARYT
WL, E14

220-240V ~50/60Hz
Matière : acier inoxydable / verre 1007601
acier / verre 1007603, 1007602, 1007600

SOCKET
INSIDE <6
W

Douille : 1xE14 Ø max. : 3,8 cm L : 11 cm

Variante	Réf.	CHF
● noir	1007603	166.80
○ blanc	1007602	166.80
● laiton	1007601	205.90
● chrome	1007600	182.90



C35 | 4,2W | 320°
2700K | 350lm | CEE=G
5kWh / 1000h



Réf. : 1005285 | 12.90 CHF



151796 329



1002964 329



SEDO 7
WL

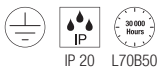
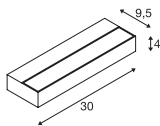

220-240V ~50/60Hz | 350mA
Puissance totale : 11,5W
Matière : aluminium / verre



Down 1020lm | 3000K

Variante	Réf.	CHF
○ blanc	1002962	229.00
● alu brossé	1002964	239.00

SEDO 14
WL

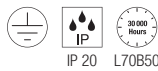
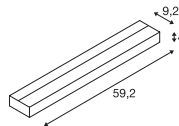

220-240V ~50/60Hz | 500mA
Puissance totale : 18W
Matière : aluminium / verre



Down 1300lm | 3000K

Variante	Réf.	CHF
○ blanc	151781	289.00
● alu brossé	151786	299.00

SEDO 21
WL

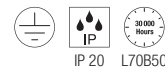
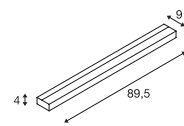

220-240V ~50/60Hz | 700mA
Puissance totale : 30W
Matière : aluminium / verre



Down 2500lm | 3000K

Variante	Réf.	CHF
○ blanc	151791	359.00
● alu brossé	151796	359.00



1004729 330

TRUKKO
WL, carré, traitement anti-buée

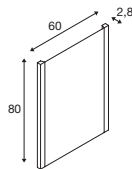
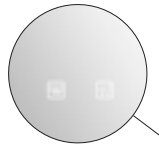

TRUKKO
WL, rectangulaire

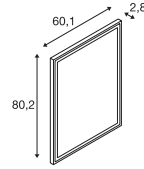
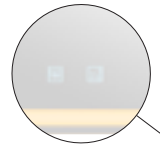

1004730 330



220-240V ~50/60Hz | 24V
Puissance totale : 24W
Matière : verre / aluminium

- Traitement anti-buée
- Sélection de la température de couleur par fonction tactile



1310lm | 3000K | 1320lm | 4000K | 1340lm | 6500K

Variante	Réf.	CHF
○ argent / verre dépoli	1004729	469.00



220-240V ~50/60Hz | 24V
Puissance totale : 25W
Matière : verre / plastique

- Traitement anti-buée
- Sélection de la température de couleur par fonction tactile



1080lm | 3000K | 1290lm | 4000K | 1250lm | 6500K

Variante	Réf.	CHF
○ argent / verre dépoli	1004730	439.00



1007201 331



TRUKKO
WL, rond

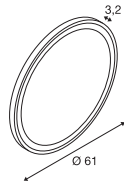
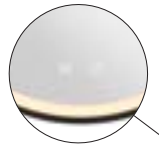

TRUKKO 80
WL, rond



220-240V ~50/60Hz | 24V
Puissance totale : 25W
Matière : verre / ABS

- Traitement anti-buée
- Sélection de la température de couleur par fonction tactile



730lm | 3000K | 710lm | 4000K | 720lm | 6500K

Variante	Réf.	CHF
○ argent / verre dépoli 1270/1260/1260lm	1004731	499.00
● transparent / noir 730/710/720lm	1007201	499.00



220-240V ~50/60Hz | 24V
Puissance totale : 23W
Matière : verre / ABS

- Traitement anti-buée
- Sélection de la température de couleur par fonction tactile



730lm | 3000K | 740lm | 4000K | 790lm | 6500K

Variante	Réf.	CHF
○ argent / verre dépoli 1100/1130/1210lm	1007200	699.00
● transparent / noir 730/740/790lm	1007202	699.00

1007202 331



TRUKKO 60
WL

TRUKKO 90
WL

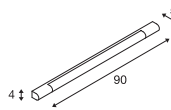
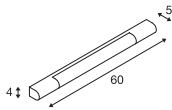

220-240V ~50/60Hz | 500mA
Puissance totale : 9,2W
Matière : aluminium / plastique

220-240V ~50/60Hz | 500mA
Puissance totale : 12W
Matière : aluminium / plastique



Down 750lm | 3000K

Down 1040lm | 3000K

Variante	Réf.	CHF
● chrome	149762	202.00

Variante	Réf.	CHF
● chrome	149772	219.00

149772 332

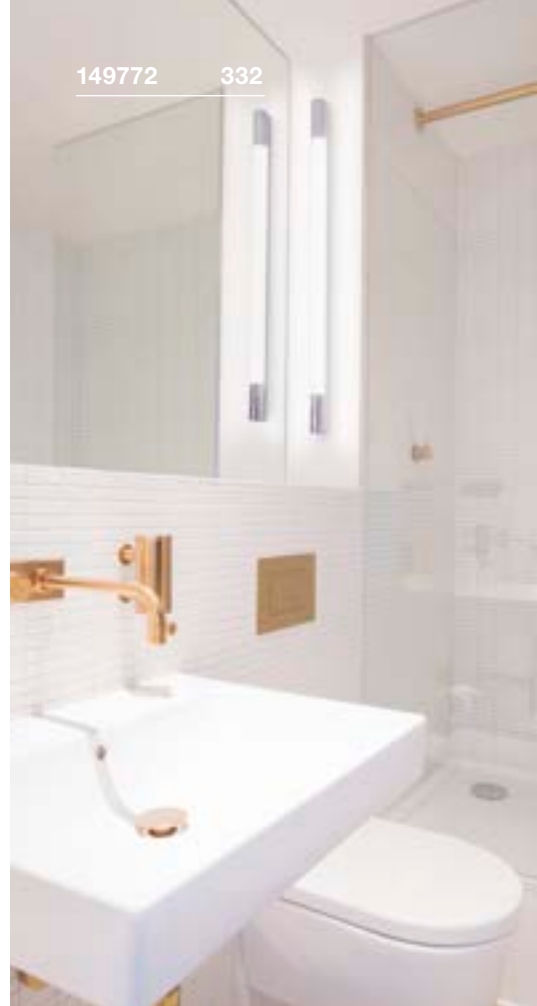

149772 332

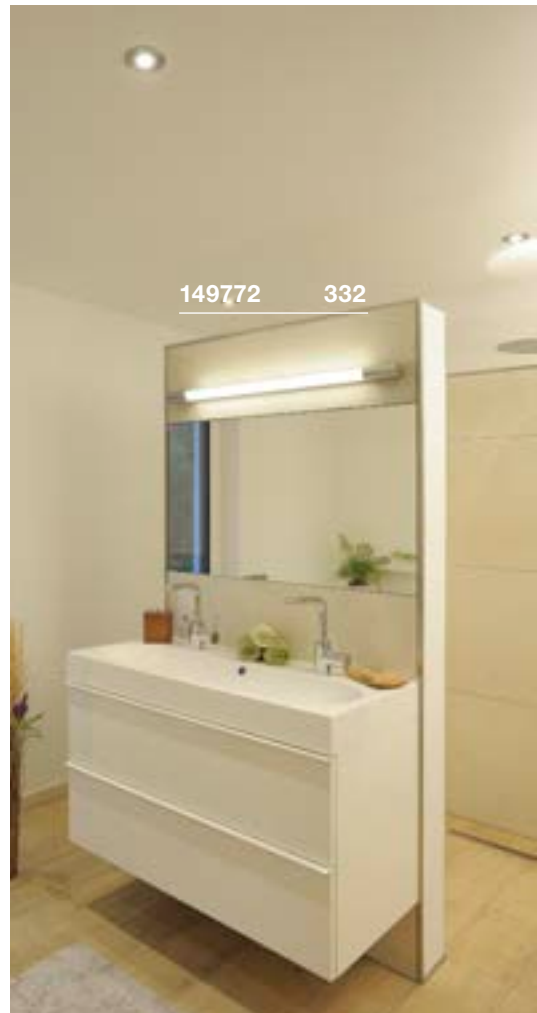



MARYLIN 40/60/90 WL



1002191 333

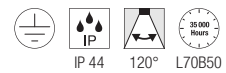
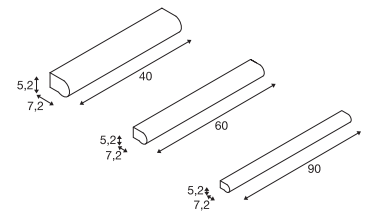

IP 44 120° L70B50

220-240V ~50/60Hz | 350mA
Puissance totale : 9,8W
Matière : aluminium / polycarbonate (PC)



Down 890lm | 3000K | 980lm | 4000K

Variante	Réf.	CHF
● chrome L : 40 cm 890/980lm 9.8W	1002190	275.00
● chrome L : 60 cm 1170/1280lm 16W	1002191	345.00
● chrome L : 90 cm 1800/1990lm 21W	1002192	419.00

WL 149
WL, PHASE

WL 149
WL, QT-DE12

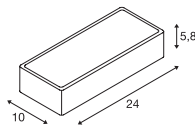
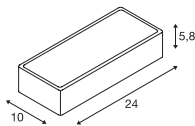

220-240V ~50/60Hz | 350mA
Puissance totale : 14W
Matière : acier / verre



220-240V ~50/60Hz
Matière : acier / verre



Down 1050lm | 3000K



Douille : R7s 78 mm

Variante	Réf.	CHF
<input type="radio"/> blanc	149511	187.00

Variante	Réf.	CHF
<input type="radio"/> blanc / dépoli	149471	99.00



LED R7s | 9W | 330°
3000K | 1050lm | CEE=E
9kWh / 1000h



Réf. : 1005287 | 27.70 CHF

149511 334



149471 334





1002228 335

WL 106
E14

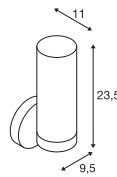

220-240V ~50/60Hz
Matière : aluminium / verre



Douille : 1xE14 Ø max. : 3,6 cm L : 11 cm

Variante	Réf.	CHF
● chrome	1002228	117.00



C35 | 4,2W | 320°
2700K | 350lm | CEE=G
5kWh / 1000h



Réf. : 1005285 | 12.90 CHF

WL 106
E14

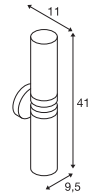

220-240V ~50/60Hz
Matière : aluminium / verre



Douilles : 2xE14 Ø max. : 3,6 cm L : 11 cm

Variante	Réf.	CHF
● chrome	1002229	209.00



C35 | 4,2W | 320°
2700K | 350lm | CEE=G
5kWh / 1000h



Réf. : 1005285 | 12.90 CHF

1004971 337





MIBO UP/DOWN WL, QT14

MAGANDA WL

151282 337

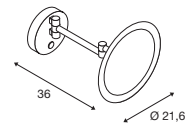
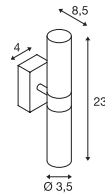

IP 21

220-240V ~50/60Hz
Matière : aluminium / verre



Douille : 2xG9

Variante	Réf.	CHF
● chrome	151282	117.00



IP 44

IK02

L70B50

90°

100-240V ~50/60Hz | 12V
Puissance totale : 4,8W
Matière : acier / verre

- Bouton de réglage de la température de couleur sur le boîtier.



45.4lm | 2700K | 48lm | 3000K | 51lm | 4000K

Variante	Réf.	CHF
● chrome	1004971	229.00



LED G9 | 3,6W | 300°
3000K | 400lm | CEE=E
4kWh / 1000h

Réf. : 1005286 | 12.90 CHF



1003507 339





DORISA 30
WL

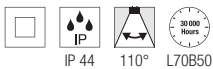
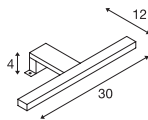

220-240V ~50Hz | 340mA
Puissance totale : 5,2W
Matière : aluminium / plastique

- Plage de serrage : 0-6 mm
- Fixation avec étai ou support à visser



Down 300lm | 4000K

Variante	Réf.	CHF
● chrome	1000777	131.00

DORISA 50
WL

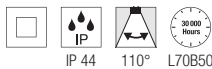
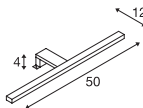

220-240V ~50Hz | 340mA
Puissance totale : 6,6W
Matière : aluminium / plastique

- Plage de serrage : 0-6 mm
- Fixation avec étai ou support à visser



Down 370lm | 4000K

Variante	Réf.	CHF
● chrome	1000780	149.00

GLENOS® 60
WL

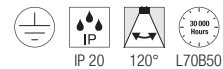
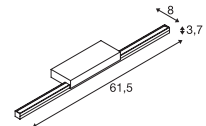

220-240V ~50/60Hz | 500mA
Puissance totale : 12W
Matière : aluminium / polycarbonate (PC)



Down 1170lm | 3000K
4000K

Variante	Réf.	CHF
● noir	1003506	209.00
○ blanc	1003507	209.00
● gris	1003508	209.00

1000669 341





L-LINE 60
WL

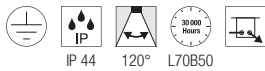
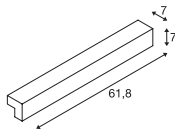

220-240V ~50/60Hz | 350mA
Puissance totale : 10W
Matière : aluminium / polycarbonate (PC)



Down 820lm | 3000K

Variante	Réf.	CHF
○ blanc	1001299	279.00
● argent	1001300	279.00

L-LINE 120
WL

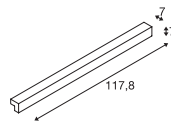

220-240V ~50/60Hz | 350mA
Puissance totale : 18,5W
Matière : aluminium / polycarbonate (PC)



Down 1650lm | 3000K

Variante	Réf.	CHF
○ blanc	1001303	419.00
● argent	1001304	419.00

Q-LINE®
WL

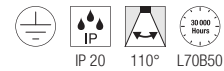
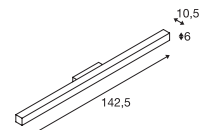

220-240V ~50/60Hz | 700mA
Puissance totale : 45W
Matière : aluminium / acrylique



Down 3800lm | 3000K

Variante	Réf.	CHF
● noir	1000669	539.00
○ blanc	1000668	539.00
● gris	1000670	539.00

CLASSES IP

Faites l'expérience de la lumière en toute sécurité. Avec les luminaires d'intérieur SLV et la bonne classe de protection IP, choisir la bonne zone d'application devient un jeu d'enfant.



Pour qu'un éclairage de salle de bain moderne soit fonctionnel et agréable, et qu'il soit aussi d'une sécurité irréprochable, il est important de choisir la bonne classe IP pour chaque zone d'utilisation.

Les initiales « IP » sont l'abréviation de « Ingress Protection », soit « protection contre les infiltrations » en anglais. Dans le monde francophone, on les fait correspondre à « Indice de Protection ». Ainsi, le code IP normé indique grâce à son premier chiffre le type de protection contre les corps solides et les contacts, tandis que le second détermine l'étanchéité à l'eau et à l'humidité. Cette dernière information étant surtout primordiale dans les salles de bain et en extérieur.

CORPS SOLIDES EAU

Aucune protection	0	0	Aucune protection
Protection contre un contact involontaire. Ex. : dos de la main (diamètre > 50 mm)	1	1	Protection contre les chutes verticales de gouttes d'eau
Protection contre un contact avec le doigt (diamètre > 12,5 mm)	2	2	Protection contre les chutes de gouttes d'eau jusqu'à 15° de la verticale
Protection contre un contact avec un outil (diamètre > 2,5 mm)	3	3	Protection contre l'eau en pluie jusqu'à 60° de la verticale
Protection contre un contact avec un fil (diamètre > 1 mm)	4	4	Protection contre les projections d'eau de toutes directions
Protection totale contre les contacts (pas de dépôt de poussière nuisible)	5	5	Protection contre les jets d'eau de toutes directions à la lance (buse)
Protection totale contre les contacts	6	6	Protection contre les jets d'eau puissants de toutes directions
		7	Protection contre les effets d'une immersion temporaire
		8	Protection contre les effets d'une immersion prolongée

EXEMPLE IP 65 :

Le niveau 6 indique que le produit présente la protection la plus élevée contre la poussière et le niveau 5 une protection élevée contre les jets d'eau à la lance. Il peut ainsi être classé comme étanche à la fois à la poussière et à l'eau.





PANTILO ROPE
WL, G9

1007595 345



NEW

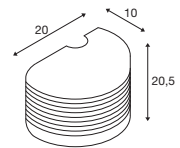

200-240V ~50/60Hz
Matière : acier

SOCKET
INSIDE <15
W

Douille : 1xG9 Ø max. : 3 cm L : 6 cm

Variante	Réf.	CHF
● or	1007595	205.90
● argent	1007594	205.90



LED G9 | 3,6W | 300°
3000K | 400lm | CEE=E
4kWh / 1000h



Réf. : 1005286 | 12.90 CHF





ASTO TUBE
WL, simple, GU10

ASTO TUBE
WL, up/down, GU10

ASTO TUBE
Réflecteur décoratif



H : 3,95 cm
Ø : 6,75 cm
Matière : polycarbonate (PC)

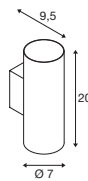
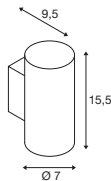

Variante	Réf.	CHF
● noir / chrome	1007190	5.20
● or	1006450	5.20
● chrome	1006449	5.20
● cuivre	1006451	5.20



220-240V ~50/60Hz
Matière : aluminium



220-240V ~50/60Hz
Matière : aluminium



Douille : 1xGU10

Variante	Réf.	CHF
● noir	1006441	74.90
○ blanc	1006442	74.90



Douilles : 2xGU10

Variante	Réf.	CHF
● noir	1006443	99.90
○ blanc	1006444	99.90



1004969 + 1004660 349



1004657 + 1004663 349

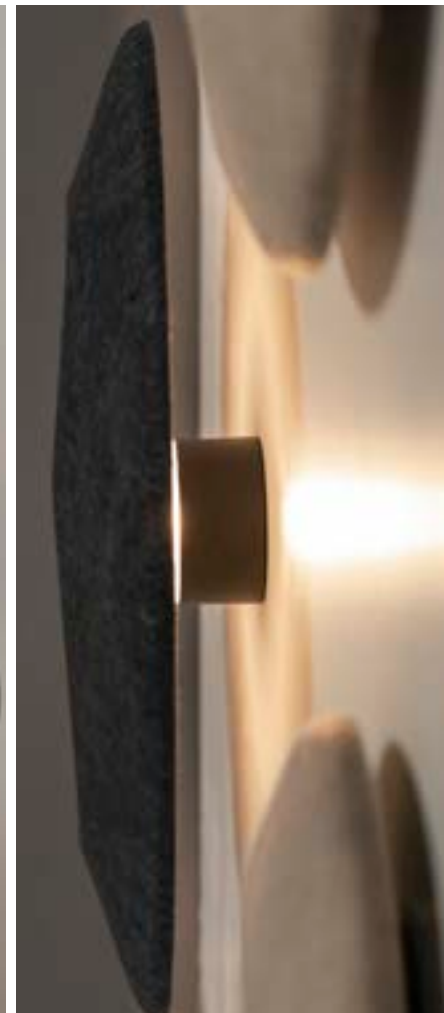



MANA BASE WL, rond, PHASE

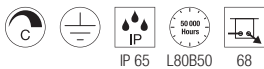
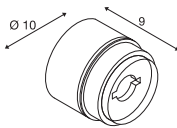

220-240V ~50/60Hz | 350mA
Puissance totale : 15W
Matière : aluminium / polycarbonate (PC)



Down 800lm | 2700K | 820lm | 3000K

Variante	Réf.	CHF
● anthracite	1006319	229.00

MANA BASE rond

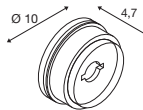

Matière : aluminium / polycarbonate (PC)

- Support de fixation non éclairé pour abat-jour rond de la série MANA

Variante	Réf.	CHF
● anthracite	1004969	33.00

MANA 40 Abat-jour, rond



H : 6 cm
Ø : 40 cm
Matière : feutre / aluminium

- La combinaison de plusieurs abat-jour en feutre sur un mur peut avoir un effet insonorisant

Variante	Réf.	CHF
● gris	1004661	124.00
● beige	1004660	124.00

MANA 60 Abat-jour, rond



H : 6 cm
Ø : 60 cm
Matière : feutre / aluminium

- La combinaison de plusieurs abat-jour en feutre sur un mur peut avoir un effet insonorisant

Variante	Réf.	CHF
● gris	1004663	172.00
● beige	1004662	172.00

1000613 + 1000824 351





MANA WL, Base, PHASE

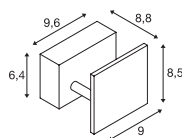

220-240V ~50/60Hz | 350mA
Puissance totale : 8,3W
Matière : aluminium / acier



Down 520lm | 2000-3000K

Variante	Réf.	CHF
○ blanc	1000613	172.00

MANA Abat-jour



IP 20

L : 12 cm H : 10 cm P : 9 cm
Matière : bois

- Compatible uniquement avec la ref. 1000613

Variante	Réf.	CHF
○ blanc	1000618	59.00
● gris / marron	1000616	59.00

MANA Abat-jour



IP 20

L : 13,6 cm H : 10 cm P : 9,5 cm
Matière : plâtre / acier

- Compatible uniquement avec la ref. 1000613
- Personnalisable avec une peinture ou un papier peint assorti au mur

Variante	Réf.	CHF
○ blanc	1000824	45.90

1000615 + 1000823 353





MANA WL, Base, PHASE

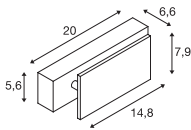

220-240V ~50/60Hz | 350mA
Puissance totale : 15W
Matière : aluminium / acier



Down 700lm | 2000-3000K

Variante	Réf.	CHF
○ blanc	1000614	202.00

MANA WL, Base

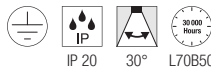
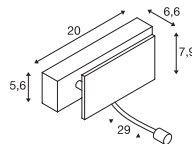

220-240V ~50/60Hz | 350/500mA
Puissance totale : 11W
Matière : aluminium / acier

- Le spot s'allume séparément



Down 650lm | 3000K

Variante	Réf.	CHF
○ blanc / chrome	1000615	249.00

MANA Abat-jour



L : 29 cm H : 9,5 cm P : 7 cm
Matière : bois

- Compatible uniquement avec les ref. 1000614/1000615

Variante	Réf.	CHF
○ blanc	1000623	74.00
● gris / marron	1000621	74.00

MANA Abat-jour

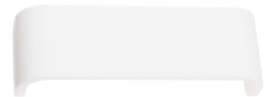

L : 30,9 cm H : 9,5 cm P : 7,4 cm
Matière : plâtre / acier

- Compatible uniquement avec les ref. 1000614/1000615
- Personnalisable avec une peinture ou un papier peint assorti au mur

Variante	Réf.	CHF
○ blanc	1000825	42.65

1006308 355

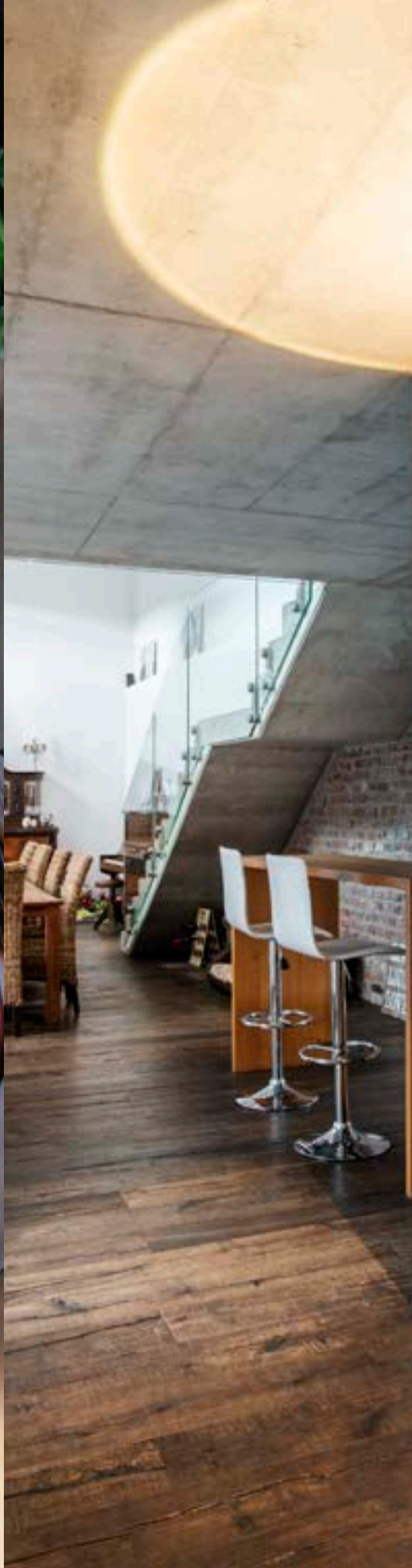



OCULUS WL, simple, PHASE



OCULUS UP/DOWN WL, PHASE



1004671 355

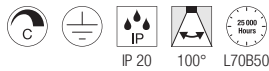
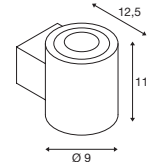
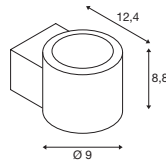

220-240V ~50/60Hz | 350mA
Puissance totale : 8,5W
Matière : aluminium / verre



220-240V ~50/60Hz | 700mA
Puissance totale : 15W
Matière : aluminium / verre

- Réflecteur dépoli supplémentaire inclus



Down 570lm | 2000-3000K



Up Down 22lm | 2000K - 555lm | 3000K

Variante	Réf.	CHF
● noir	1006307	279.00
○ blanc	1006308	279.00

Variante	Réf.	CHF
● noir	1004670	329.00
○ blanc	1004671	329.00

PLASTRA
WL, Cube, QT14

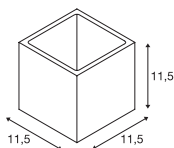

220-240V ~50/60Hz
Matière : plâtre / acier

- Personnalisable avec une peinture ou un papier peint assorti au mur



Douille : 1xG9

Variante	Réf.	CHF
<input type="radio"/> blanc	148018	74.00



LED G9 | 3,6W | 300°
3000K | 400lm | CEE=E
4kWh / 1000h

Réf. : 1005286 | 12.90 CHF



PLASTRA
WL, Cubes

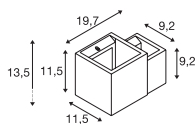
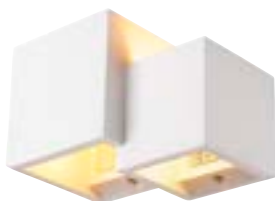

220-240V ~50/60Hz
Matière : plâtre / acier

- Personnalisable avec une peinture ou un papier peint assorti au mur



Douille : 2xG9 Ø max. : 7 cm L : 4 cm

Varianteé	Ref.	CHF
<input type="radio"/> blanc	1004733	70.00



LED G9 | 3,6W | 300°
3000K | 400lm | CEE=E
4kWh / 1000h

Réf. : 1005286 | 12.90 CHF

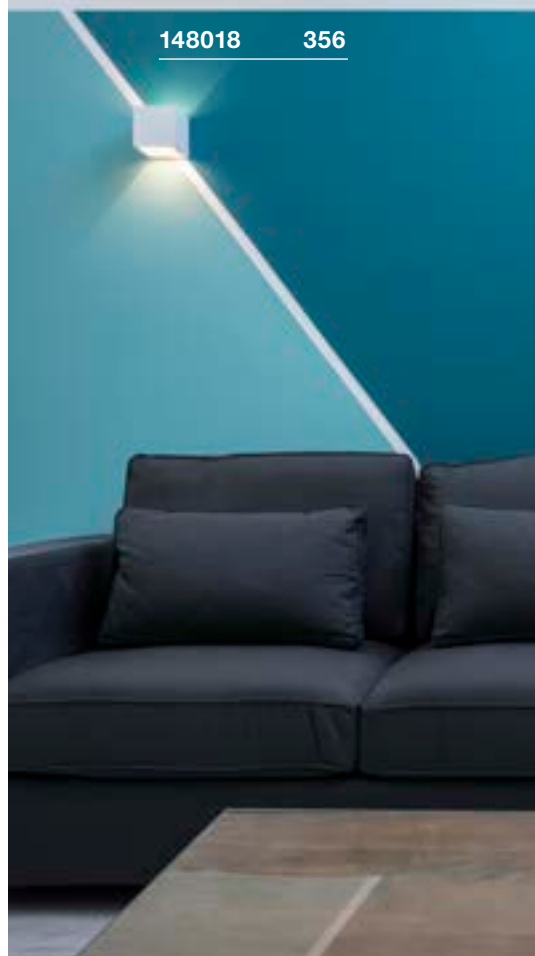

148018 356



1002238 357



PLASTRA
WL, rectangulaire, QT-DE12

PLASTRA
WL, E14

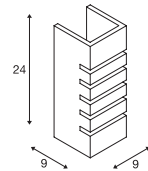
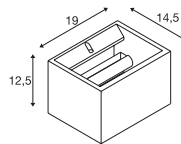

IP 20

220-240V ~50/60Hz
Matière : plâtre / acier

- Personnalisable avec une peinture ou un papier peint assorti au mur



Douille : 1xR7s 118 mm

Variante	Réf.	CHF
<input type="radio"/> blanc	1002238	106.00



LED R7s | 15W | 330°
3000K | 2000lm | CEE=E
15kWh / 1000h



Réf. : 1005288 | 35.00 CHF



IP 20

220-240V ~50/60Hz
Matière : plâtre / acier

- Personnalisable avec une peinture ou un papier peint assorti au mur



Douille : 1xE14

Variante	Réf.	CHF
<input type="radio"/> blanc	148010	64.00



C35 | 4,2W | 320°
2700K | 350lm | CEE=G
5kWh / 1000h



Réf. : 1005285 | 12.90 CHF



148010

357

1004732 359



148091 359

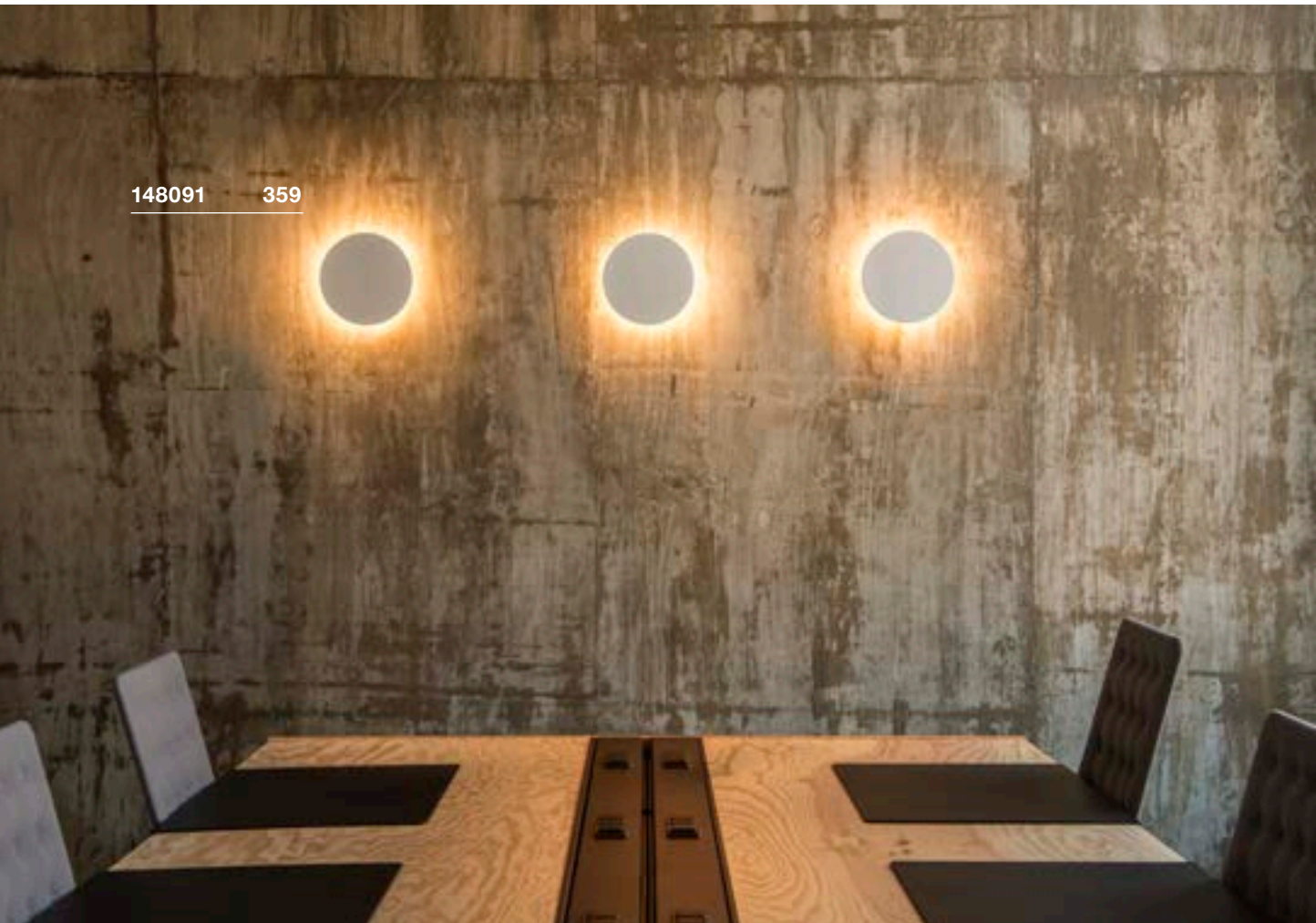



PLASTRA WL, Demi-cercle

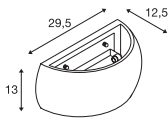

IP 20

220-240V ~50/60Hz
Matière : plâtre / acier

- Personnalisable avec une peinture ou un papier peint assorti au mur



Douille :
1x R7s 118 mm Ø max. : 2 cm L : 11,8 cm

Variante	Réf.	CHF
<input type="radio"/> blanc	1004732	85.00



LED R7s | 15W | 330°
3000K | 2000lm | CEE=E
15kWh / 1000h



Réf. : 1005288 | 35.00 CHF

PLASTRA WL, rond

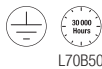
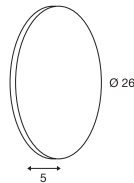

L70B50

100-240V ~50/60Hz | 12V
Puissance totale : 6,5W
Matière : plâtre / acier

- Personnalisable avec une peinture ou un papier peint assorti au mur



Down 375lm | 3000K

Variante	Réf.	CHF
<input type="radio"/> blanc	148091	202.00

PLASTRA WL, carré

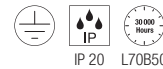
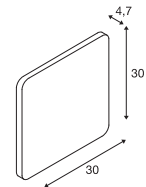

IP 20 L70B50

100-240V ~50/60Hz | 12V
Puissance totale : 10,5W
Matière : plâtre / acier

- Personnalisable avec une peinture ou un papier peint assorti au mur



Down 650lm | 3000K

Variante	Réf.	CHF
<input type="radio"/> blanc	148019	259.00



148060 360

PLASTRA WL, QPAR51

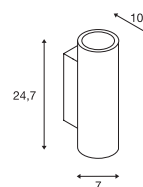

148013 361



220-240V ~50/60Hz
Matière : plâtre / acier

- Personnalisable avec une peinture ou un papier peint assorti au mur

SOCKET
INSIDE <35
W

Douilles : 2xGU10

Variante	Réf.	CHF
○ blanc	148060	85.00



LED GU10 51mm | 6W | 36°
2200-2700K | 360lm | CEE=G



Réf. : 1005273 | 12.90 CHF



PLASTRA 101
WL, E14

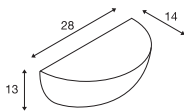

220-240V ~50/60Hz
Matière : plâtre / acier

- Personnalisable avec une peinture ou un papier peint assorti au mur



Douille : 1xE14 Ø max. : 4,5 cm L : 11 cm

Variante	Réf.	CHF
○ blanc	148013	74.00



C35 | 4,2W | 320°
2700K | 350lm | CEE=G
5kWh / 1000h



Réf. : 1005285 | 12.90 CHF

PLASTRA
WL, Curve, QT-DE12

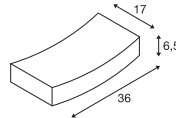

220-240V ~50/60Hz
Matière : plâtre / acier

- Personnalisable avec une peinture ou un papier peint assorti au mur



Douille : 1xR7s 78 mm

Variante	Réf.	CHF
○ blanc	148012	88.00



LED R7s | 9W | 330°
3000K | 1050lm | CEE=E
9kWh / 1000h



Réf. : 1005287 | 27.70 CHF

PLASTRA 104
WL, QT14

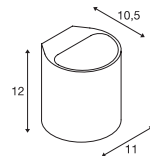

220-240V ~50/60Hz
Matière : plâtre / acier

- Personnalisable avec une peinture ou un papier peint assorti au mur



Douille : 1xG9

Variante	Réf.	CHF
○ blanc	148016	74.00



LED G9 | 3,6W | 300°
3000K | 400lm | CEE=E
4kWh / 1000h



Réf. : 1005286 | 12.90 CHF



151321 X362X



1000638 362

LOGS IN WL

LOGS IN WL, PHASE

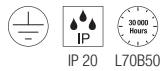
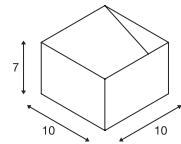
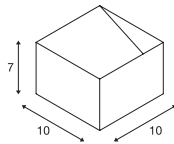

100-240V ~50/60Hz | 500mA
Puissance totale : 6W
Matière : aluminium



Down 300lm | 3000K
470lm

Variante	Réf.	CHF
● noir / or 300lm	151320	166.00
○ blanc 470lm	151321	156.00



220-240V ~50/60Hz | 250mA
Puissance totale : 11W
Matière : aluminium



Down 430-690lm | 2000-3000K

Variante	Réf.	CHF
● noir / or 430lm	1000638	209.00
○ blanc 690lm	1000639	209.00
● alu brossé / blanc 690lm	1000640	209.00



1002843 363

LOGS IN L
WL, PHASE

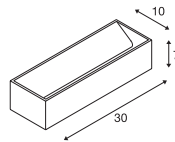

220-240V ~50/60Hz | 500mA
Puissance totale : 18W
Matière : aluminium



Down 1100lm | 1600lm | 3000K

Variante	Réf.	CHF
● noir / or 1100lm	1002842	279.00
○ blanc 1600lm	1002844	279.00
● alu brossé / blanc 1600lm	1002843	279.00

LOGS IN L
WL, PHASE

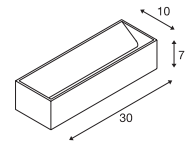

220-240V ~50/60Hz | 500mA
Puissance totale : 21W
Matière : aluminium



Down 1000lm | 2000-3000K

Variante	Réf.	CHF
● noir / or 1000lm	1002928	379.00
○ blanc 1390lm	1002929	349.00



1002928 363



1003467 364

QUAD FRAME 14 WL

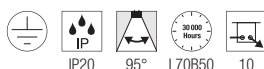
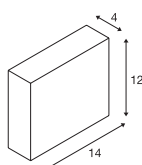

100-240V ~50/60Hz | 350mA
Puissance totale : 4,4W
Matière : aluminium



Down 165lm | 2700K | 175lm | 3000K

Variante	Réf.	CHF
○ blanc	1003467	124.00

QUAD FRAME 19 WL

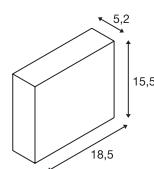

220-240V ~50/60Hz | 500mA
Puissance totale : 11W
Matière : aluminium



Down 580lm | 2700K | 640lm | 3000K

Variante	Réf.	CHF
○ blanc	1003468	145.00



1003468 364



1000422 365

SHELL 15
WL, PHASE

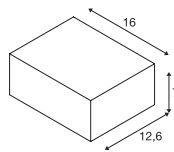

220-240V ~50/60Hz | 350mA
Puissance totale : 15W
Matière : aluminium / acrylique



Down 1400lm | 3000K

Variante	Réf.	CHF
<input type="radio"/> blanc	1000422	309.00

SHELL 30
WL, PHASE

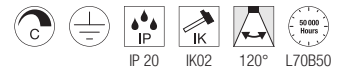
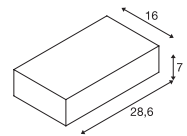

220-240V ~50/60Hz | 700mA
Puissance totale : 54W
Matière : aluminium / acrylique



Down 5600lm | 3000K

Variante	Réf.	CHF
<input type="radio"/> blanc	1000423	449.00



1000423 365



151275 366

ASSO 300 WL, PHASE

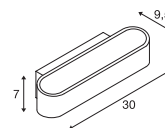

151410 366



IP 20 L70B50

220-240V ~50/60Hz | 500mA

Puissance totale : 12W

Matière : aluminium / acier



Down

975lm | 3000K

Variante	Réf.	CHF
○ blanc	151271	239.00
● alu brossé / blanc	151275	259.00



ASSO 300
WL, PHASE

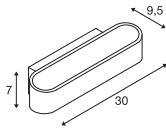

220-240V ~50/60Hz | 500mA
Puissance totale : 21W
Matière : aluminium / acier



Down 1340lm | 2000-3000K

Variante	Réf.	CHF
○ blanc	1000634	289.00

OSSA 180
WL, QT-DE12

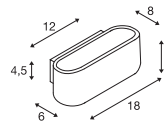

220-240V ~50/60Hz
Matière : aluminium / acier



Douille : 1xR7s 78 mm

Variante	Réf.	CHF
● noir	151450	109.00
○ blanc	151451	109.00
● alu brossé	151456	128.00



LED R7s | 9W | 330°
3000K | 1050lm | CEE=E
9kWh / 1000h



Réf. : 1005287 | 27.70 CHF

OSSA 300
WL, QT-DE12

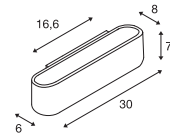

220-240V ~50/60Hz
Matière : aluminium / acier



Douille : 1xR7s 118 mm

Variante	Réf.	CHF
● noir	151410	149.00
○ blanc	151411	149.00



LED R7s | 15W | 330°
3000K | 2000lm | CEE=E
15kWh / 1000h



Réf. : 1005288 | 35.00 CHF

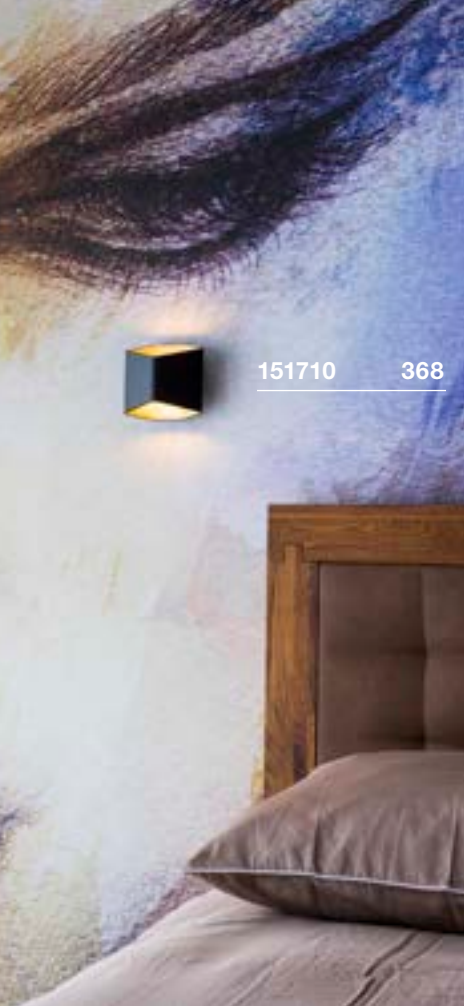

151710 368



151740 368

CARISO WL, PHASE

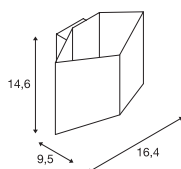

220-240V ~50/60Hz | 500mA
Puissance totale : 9,2W
Matière : aluminium / acier



Down 250lm | 2700K
560lm | 3000K

Variante	Réf.	CHF
●● noir / or 250lm 2700K	151710	219.00
○ blanc 560lm 3000K	151711	219.00

CARISO WL, PHASE

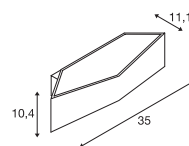

220-240V ~50/60Hz | 500mA
Puissance totale : 21W
Matière : aluminium / acier



Down 580lm | 1700-2700K
1030lm | 2000-3000K

Variante	Réf.	CHF
●● noir / or 580lm 1700-2700K	151740	359.00
○ blanc 1030lm 2000-3000K	151741	359.00

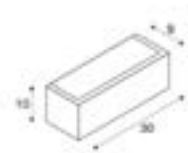
**CHROMBO**
WL, PHASE

1003317 369

220-240V ~50/60Hz | 350mA
Puissance totale : 11W
Matière : acier / verre

Down

700lm | 3000K

Variante	Réf.	CHF
○ blanc	1003316	202.00
● gris	1003317	202.00

DIRETO 60
WL, PHASE

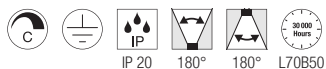
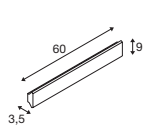
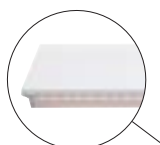

220-240V ~50/60Hz | 500mA
Puissance totale : 14W
Matière : aluminium



Up 590lm | 2700K | 625lm | 3000K
Down

Variante	Réf.	CHF
● noir	1004740	259.00
○ blanc	1004741	259.00

DIRETO 90
WL, PHASE

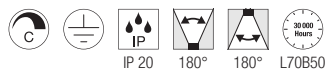
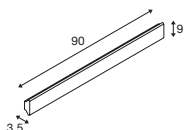
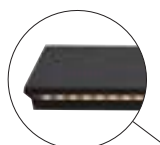

220-240V ~50/60Hz | 500mA
Puissance totale : 20W
Matière : aluminium



Up 840lm | 2700K | 880lm | 3000K
Down

Variante	Réf.	CHF
● noir	1004742	309.00
○ blanc	1004743	309.00

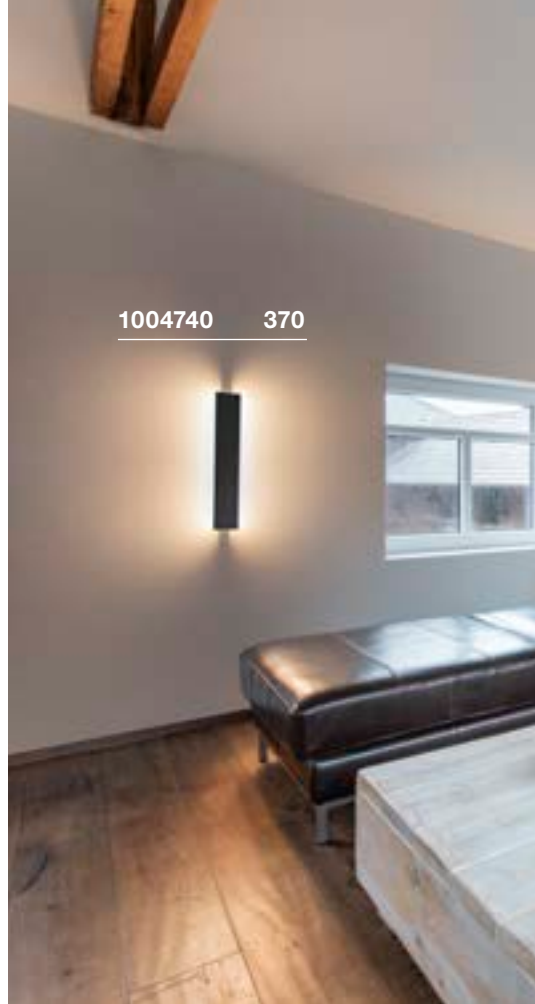

1004740 370



1004743 370



ARLINA 60
WL

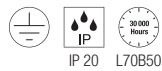
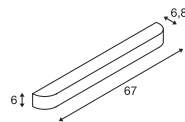

220-240V ~50/60Hz | 500mA
Puissance totale : 23W
Matière : aluminium / verre



Down 1550lm | 3000K

Variante	Réf.	CHF
● alu brossé	1002239	269.00

ARLINA 130
WL

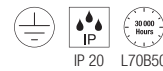
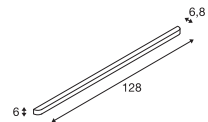

220-240V ~50/60Hz | 700mA
Puissance totale : 28W
Matière : aluminium / verre



Down 2400lm | 3000K

Variante	Réf.	CHF
● alu brossé	1002240	369.00





147529 373

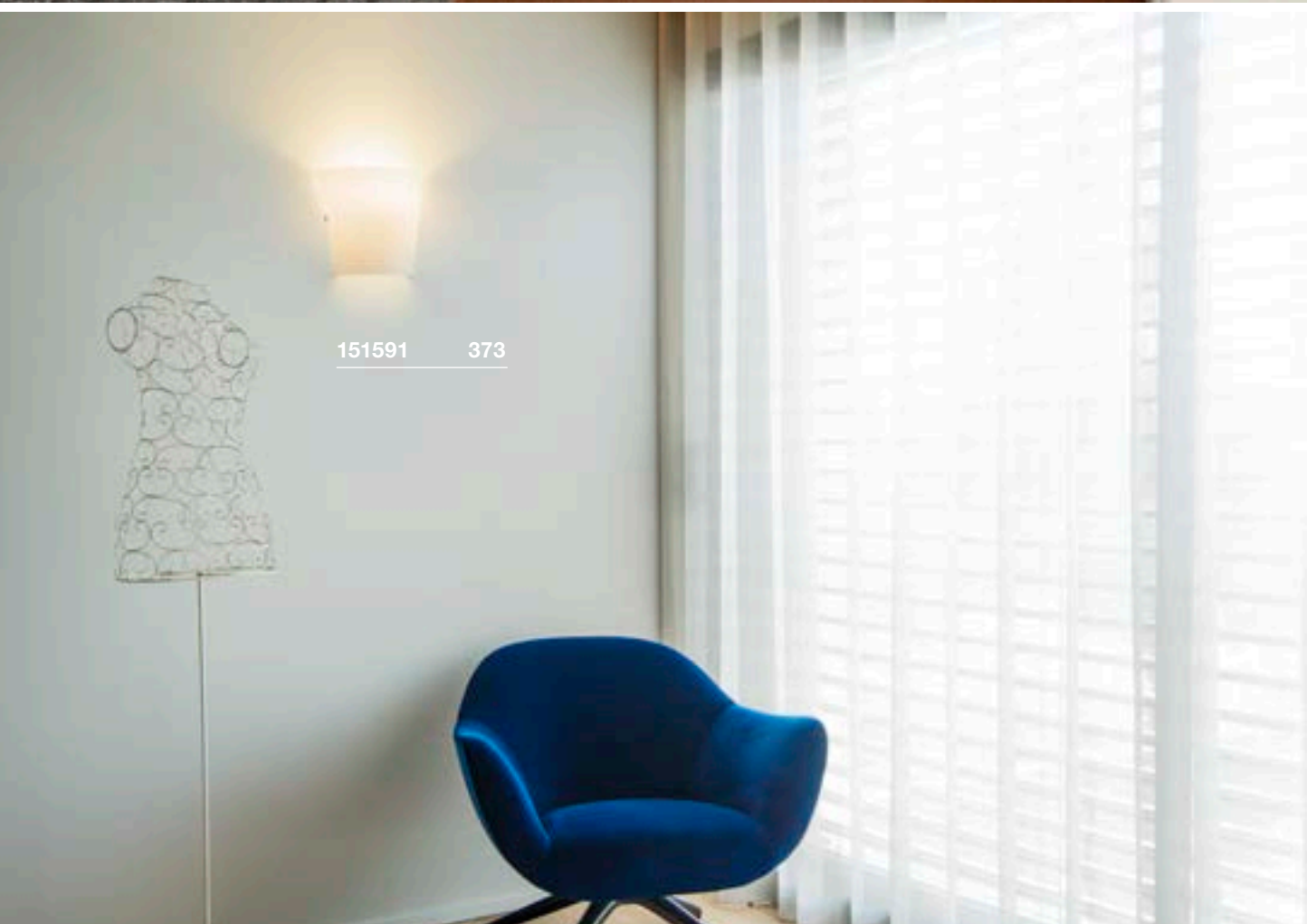

151591 373



ANDREAS
WL, QT-DE12

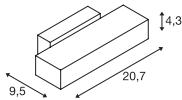

220-240V ~50/60Hz
Matière : aluminium / acier



Douille : 1xR7s 118 mm

Variante	Réf.	CHF
● noir	1002927	138.00
○ blanc	1002925	138.00



LED R7s | 15W | 330°
3000K | 2000lm | CEE=E
15kWh / 1000h



Réf. : 1005288 | 35.00 CHF

DENA 30
WL, E14

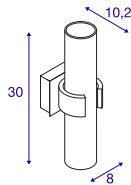

220-240V ~50/60Hz
Matière : aluminium



Douilles : 2xE14 Ø max. : 5,1 cm L : 9,6 cm

Variante	Réf.	CHF
● alu brossé	147529	124.00



C35 | 4,2W | 320°
2700K | 350lm | CEE=G
5kWh / 1000h



Réf. : 1005285 | 12.90 CHF

BASKET
WL, E27

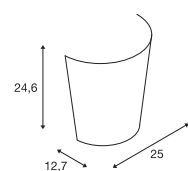

220-240V ~50/60Hz
Matière : verre



Douille : 1xE27 Ø max. : 5,2 cm L : 15,2 cm

Variante	Réf.	CHF
○ blanc	151591	117.00



LED E27 | 8W | 240°
3000K | 880lm | CEE=E
8kWh / 1000h



Réf. : 1005289 | 12.90 CHF

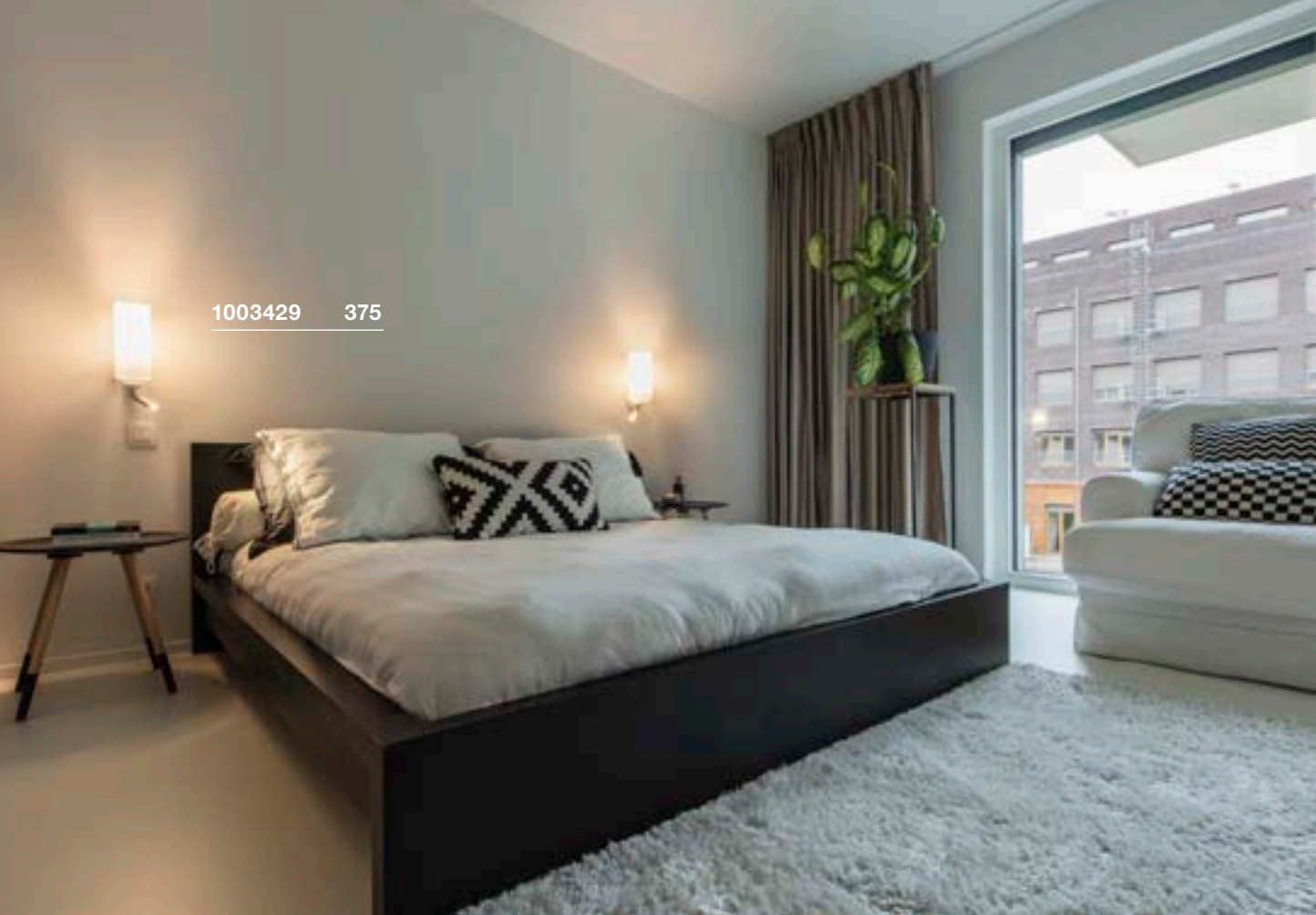

1003429 375

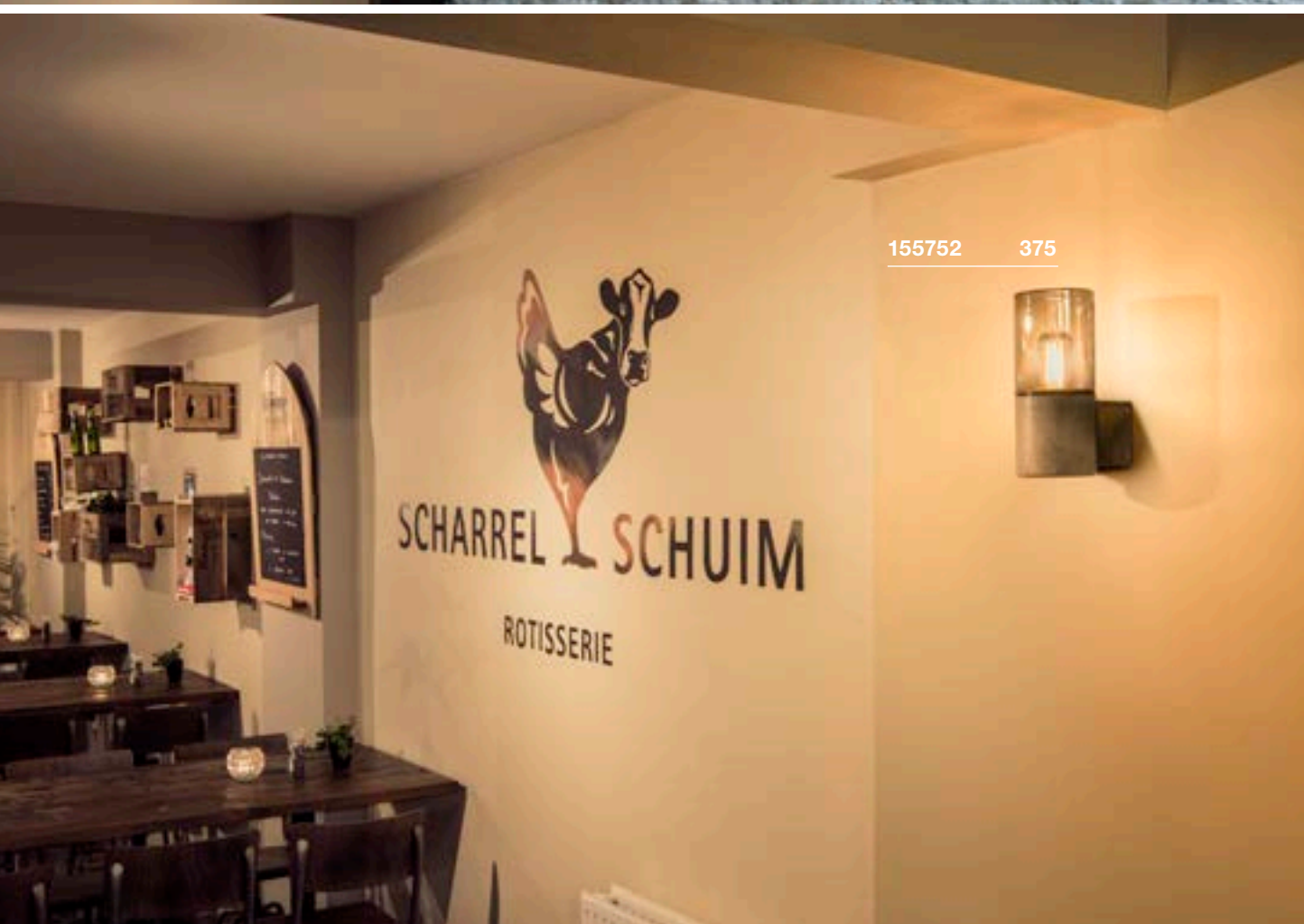

155752 375



QUADRASS WL, E27

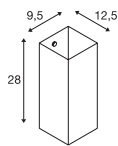

220-240V ~50/60Hz
Matière : acier / verre



Douille : 1xE27 Ø max. : 6,5 cm L : 18 cm

Variante	Réf.	CHF
● noir / verre dépoli	1003430	155.00
○ blanc / verre dépoli	1003431	155.00



LED E27 | 13,2W | 220°
2700K | 1300lm | CEE=F
13kWh / 1000h



Réf. : 1005302 | 17.00 CHF

QUADRASS SPOT WL, E27

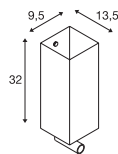

100-240V ~50/60Hz | 700mA
Puissance totale : 2W
Matière : acier / verre

- Interrupteur sur le boîtier du luminaire
- Les sources lumineuses peuvent être allumées séparément



Down 200lm | 3000K



Douille : 1xE27 Ø max. : 6,5 cm L : 18 cm

Variante	Réf.	CHF
● noir	1003428	235.00
○ blanc	1003429	235.00



A60 | 7,5W | 320°
2700K | 800lm | CEE=F
8kWh / 1000h



Réf. : 1005303 | 12.90 CHF

LISENNE WL, E27

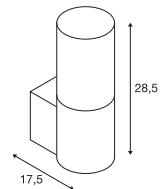

220-240V ~50/60Hz
Matière : basalte / verre



Douille : 1xE27 Ø max. : 5,9 cm L : 15 cm

Variante	Réf.	CHF
● gris / marron	155752	289.00



LED E27 | 8W | 240°
3000K | 880lm | CEE=E
8kWh / 1000h



Réf. : 1005289 | 12.90 CHF

FITU
Support mural

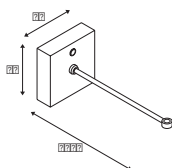

Matière : acier

- Suspensions compatibles disponibles en page 295

Variante	Réf.	CHF
● noir	1004682	85.00

FITU CUBE
WL, E27

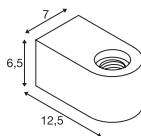

220-240V ~50/60Hz
Matière : acier



Douille : 1xE27 Ø max. : 12,5 cm

Variante	Réf.	CHF
● noir	1004738	99.00
○ blanc	1004739	99.00



A60 | 7,5W | 180°
2700K | 720lm | CEE=F
8kWh / 1000h



Réf. : 1005305 | 24.50 CHF

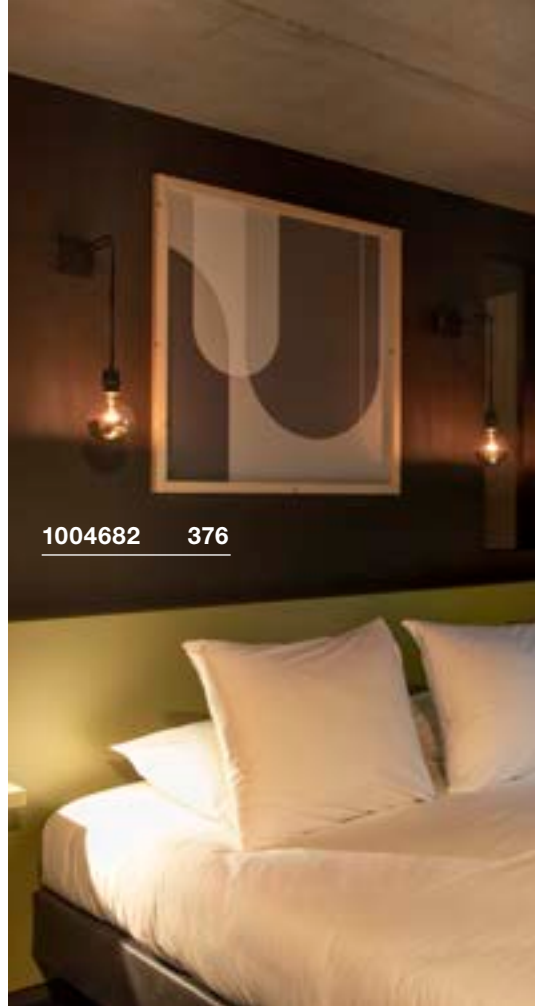

1004682 376

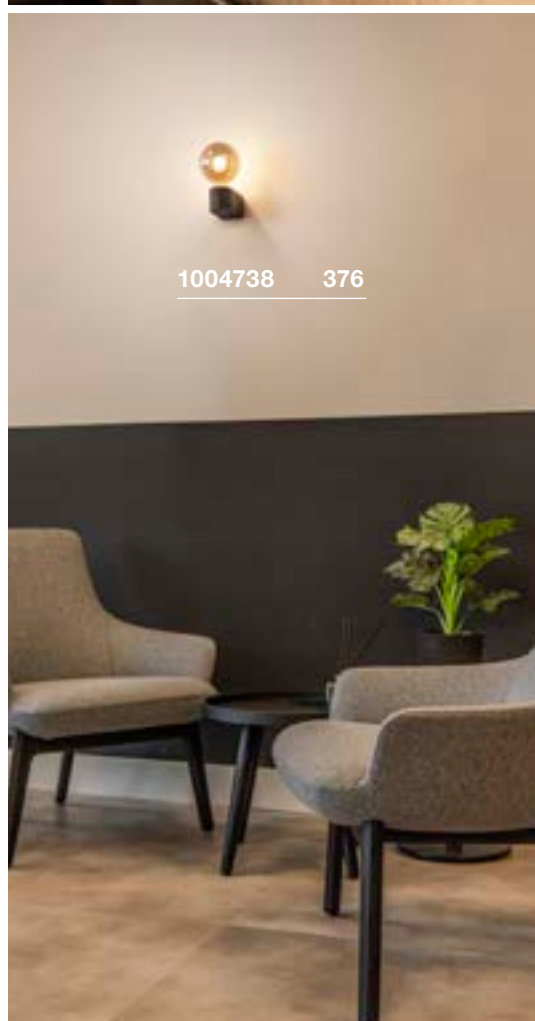

1004738 376



1000327 377

THEO UP/DOWN
WL, QPAR51

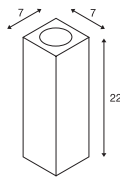

220-240V ~50/60Hz
Matière : aluminium



Douilles : 2xGU10

Variante	Réf.	CHF
● anthracite	1000330	138.00
○ blanc	1000327	138.00
● alu brossé	1000329	138.00



LED GU10 51mm | 6W | 38°
2700K | 450lm | CEE=F
6kWh / 1000h



Réf. : 1005077 | 10.60 CHF



220-240V ~50/60Hz
Matière : béton



Douille : 1xG9

Variante	Réf.	CHF
● gris	1000910	117.00
● noir	1000911	117.00



LED G9 | 3,6W | 300°
3000K | 400lm | CEE=E
4kWh / 1000h



Réf. : 1005286 | 12.90 CHF



1000910 377

SOLID CUBE
WL, QT14

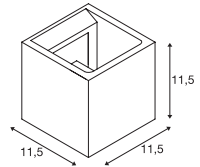

151803 379





ENOLA B
WL, QPAR51

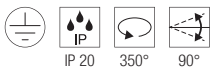
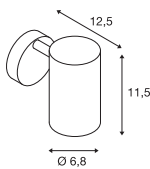

220-240V ~50/60Hz
Matière : aluminium / acier

- Interrupteur sur le boîtier du luminaire



Douille : 1xGU10 L max. : 6 cm

Variante	Réf.	CHF
● noir	1000729	117.00
○ blanc	1000730	117.00

LED GU10 51mm | 6W | 38°
 2700K | 450lm | CEE=F
 6kWh / 1000h

Réf. : 1005077 | 10.60 CHF

Article	Réf.	CHF
Anneau déco noir		
● noir	151840	12.75

ENOLA B
WL, QPAR51

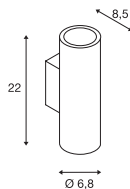

220-240V ~50/60Hz
Matière : aluminium / acier



Douilles : 2xGU10 L max. : 8,5 cm

Variante	Réf.	CHF
● noir	151800	128.00
○ blanc	151801	128.00
● or	151803	138.00

LED GU10 51mm | 6W | 38°
 2700K | 450lm | CEE=F
 6kWh / 1000h

Réf. : 1005077 | 10.60 CHF

Article	Réf.	CHF
Anneau déco noir		
● noir	151840	12.75

ASTINA UP/DOWN
WL, QPAR51

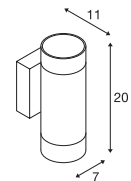

220-240V ~50/60Hz
Matière : aluminium / acier



Douilles : 2xGU10

Variante	Réf.	CHF
● noir	1002933	138.00
○ blanc	1002931	138.00

LED GU10 51mm | 6W | 36°
 2200-2700K | 360lm | CEE=G
 6kWh / 1000h

Réf. : 1005273 | 12.90 CHF

FENDA
WL, Base, E27

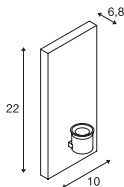

220-240V ~50/60Hz
Matière : acier / plastique



Douille : 1xE27 Ø max. : 5,1 cm L : 20 cm

Variante	Réf.	CHF
○ blanc	1001272	66.00



LED E27 | 8W | 240°
3000K | 880lm | CEE=E
8kWh / 1000h



Réf. : 1005289 | 12.90 CHF

FENDA
Abat-jour demi-cercle



L : 23 cm H : 30 cm P : 12 cm
Matière : textile / acier

Variante	Réf.	CHF
● noir	1001273	49.10
● noir / cuivre	1001274	55.00
○ blanc	1001275	49.10
● beige	1001276	49.10

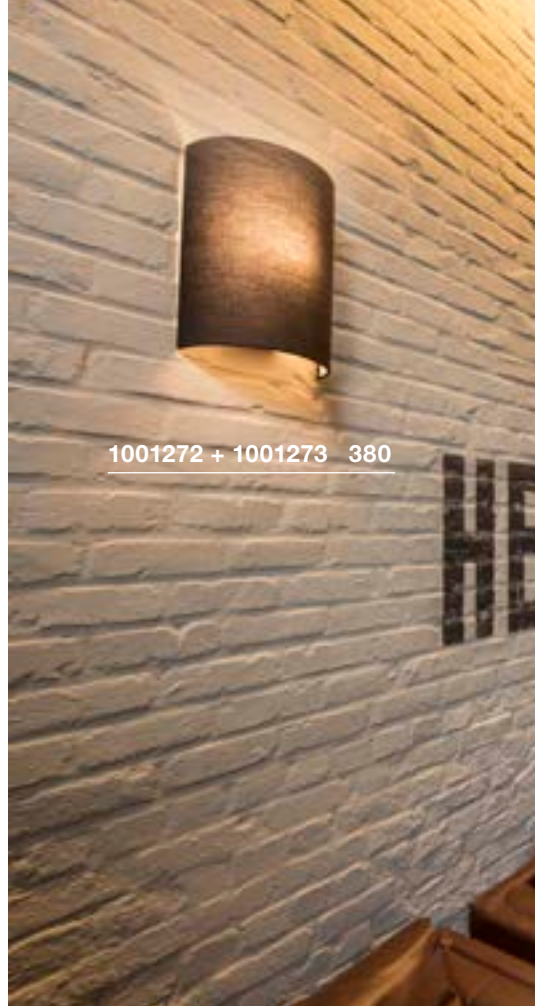

1001272 + 1001273 380



149452 381



KENKUA SPOT WL, E27

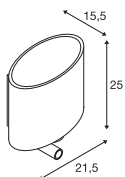

100-240V ~50/60Hz | 700mA
Puissance totale : 2W
Matière : acier / verre

- Les sources peuvent être allumées séparément via un interrupteur.



Down 200lm | 3000K



Douille : 1xE27 Ø max. : 6,5 cm | L : 12 cm

Variante	Réf.	CHF
● chrome	1002855	219.00



A60 | 7,5W | 320°
2700K | 800lm | CEE=F
8kWh / 1000h



Réf. : 1005303 | 12.90 CHF

COUPA FLEX WL

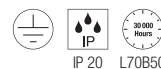
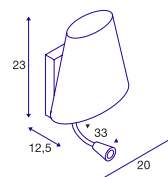

220-240V ~50/60Hz | 700mA
Puissance totale : 3,2W
Matière : acier / verre

- Les sources peuvent être allumées séparément via un interrupteur.



Down 140lm | 3000K



Douille : 1xG9 L max. : 9 cm

Variante	Réf.	CHF
● chrome / verre dépoli	149452	269.00



LED G9 | 3,6W | 300°
3000K | 400lm | CEE=E
4kWh / 1000h



Réf. : 1005286 | 12.90 CHF



KARPO MAGN
CW, simple, PHASE

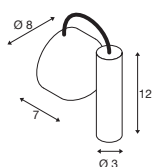

220-240V ~50/60Hz | 500mA
Puissance totale : 6,2W
Matière : acier / aluminium

- Positionnement libre grâce au support magnétique



Down 350lm | 430lm | 3000K

Variante	Réf.	CHF
● noir		
350lm	1004706	235.00
○ blanc		
430lm	1004707	235.00

KARPO GOOSE
WL

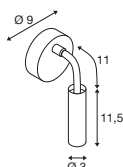

220-240V ~50/60Hz | 12V
Puissance totale : 5,8W
Matière : aluminium / acier

- Variable via un bouton situé sur la tête de lampe.



Down 380lm | 420lm | 3000K

Variante	Réf.	CHF
● noir		
380lm	1006162	209.00
○ blanc		
420lm	1006161	209.00

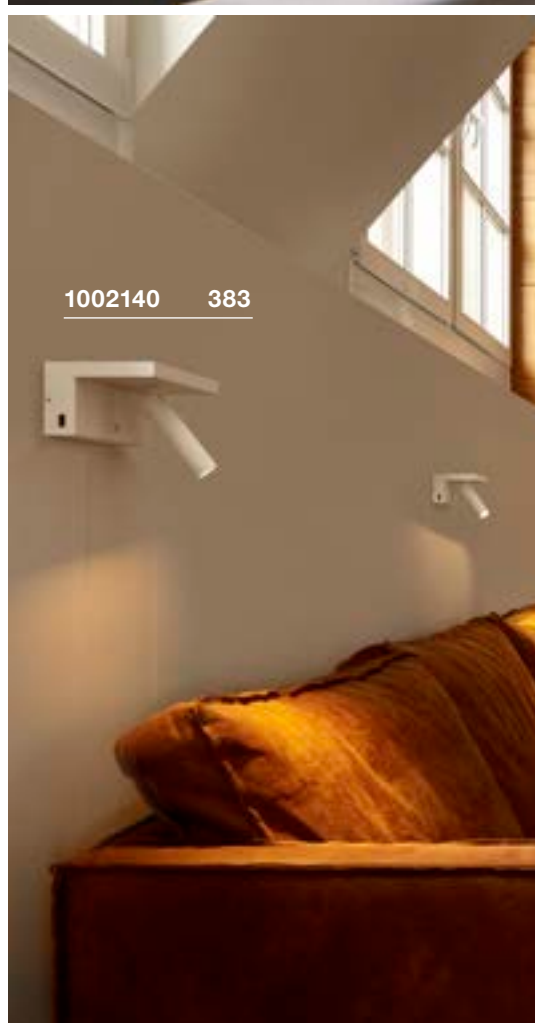

1002140 383



KARPO 30 WL, simple

KARPO WL



1004707 382

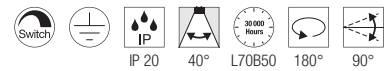
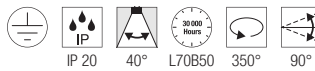
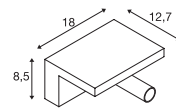
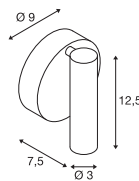

100-240V ~50/60Hz | 500mA
Puissance totale : 6W
Matière : aluminium / acier

220-240V ~50/60Hz | 500mA
Puissance totale : 6,8W
Matière : aluminium

- Interrupteur sur le boîtier du luminaire

- 2 prises USB 1,5 A max
- Variable sur 3 niveaux via un bouton situé sur la base



Down 370lm | 400lm 3000K

Down 390lm | 3000K

Variante	Réf.	CHF
● noir		
370lm	152340	160.00
○ blanc		
400lm	152341	160.00

Variante	Réf.	CHF
○ blanc	1002140	289.00





1003457 384

SOMNILA SPOT WL, gauche

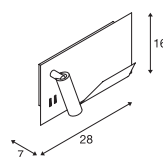

1003459 385



100-240V ~50/60Hz | 12V
Puissance totale : 15W
Matière : aluminium / acier

- 1 prise USB
- Les sources lumineuses peuvent être allumées séparément sur l'appareil



Down

120lm | 3000K

Variante	Réf.	CHF
● noir 490lm	1003455	259.00
○ blanc 770lm	1003457	259.00



SOMNILA SPOT WL, droite

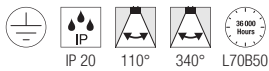

100-240V ~50/60Hz | 12V
Puissance totale : 15W
Matière : aluminium / acier

- 1 prise USB
- Les sources lumineuses peuvent être allumées séparément sur l'appareil



Down 120lm | 3000K

SOMNILA FLEX WL, gauche

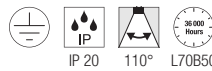

100-240V ~50/60Hz | 12V
Matière : aluminium

- Les sources lumineuses peuvent être allumées séparément sur l'appareil.



Down 120lm | 3000K



Douille : 1xE27 L max. : 18 cm

SOMNILA FLEX WL, droite

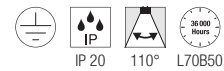

100-240V ~50/60Hz | 12V
Matière : aluminium

- Les sources lumineuses peuvent être allumées séparément sur l'appareil.



Down 120lm | 3000K



Douille : 1xE27 L max. : 18 cm

Variante	Réf.	CHF
● noir 490lm	1003456	259.00
○ blanc 770lm	1003458	259.00

Variante	Réf.	CHF
○ blanc	1003459	279.00

Coloris	Réf.	CHF
○ blanc	1003460	279.00



1002608 387

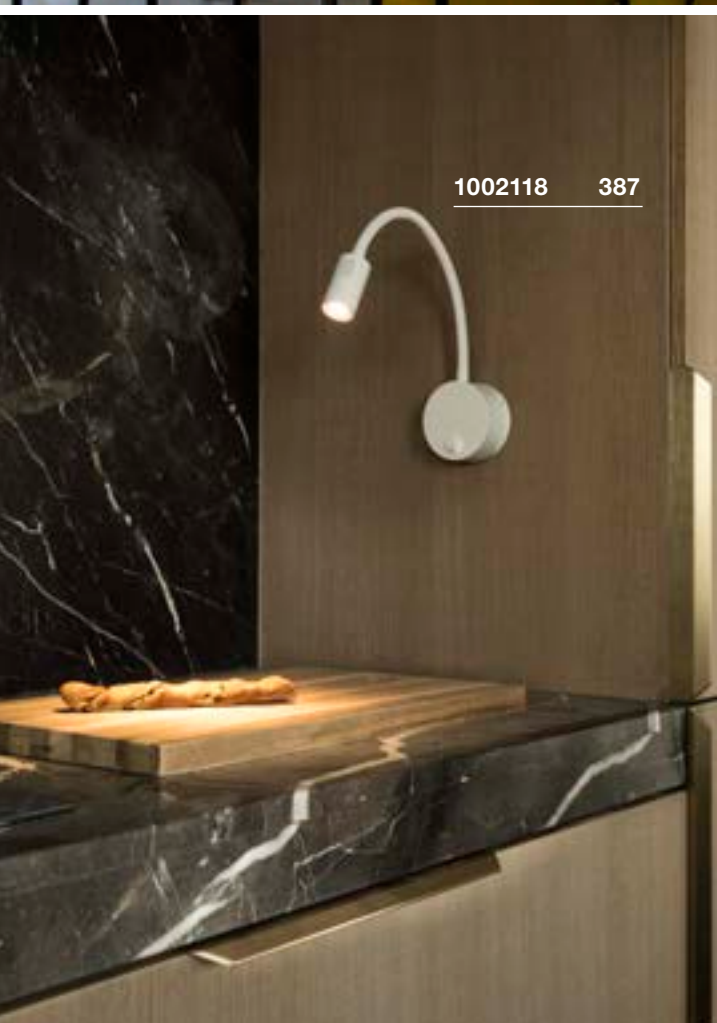

1002118 387

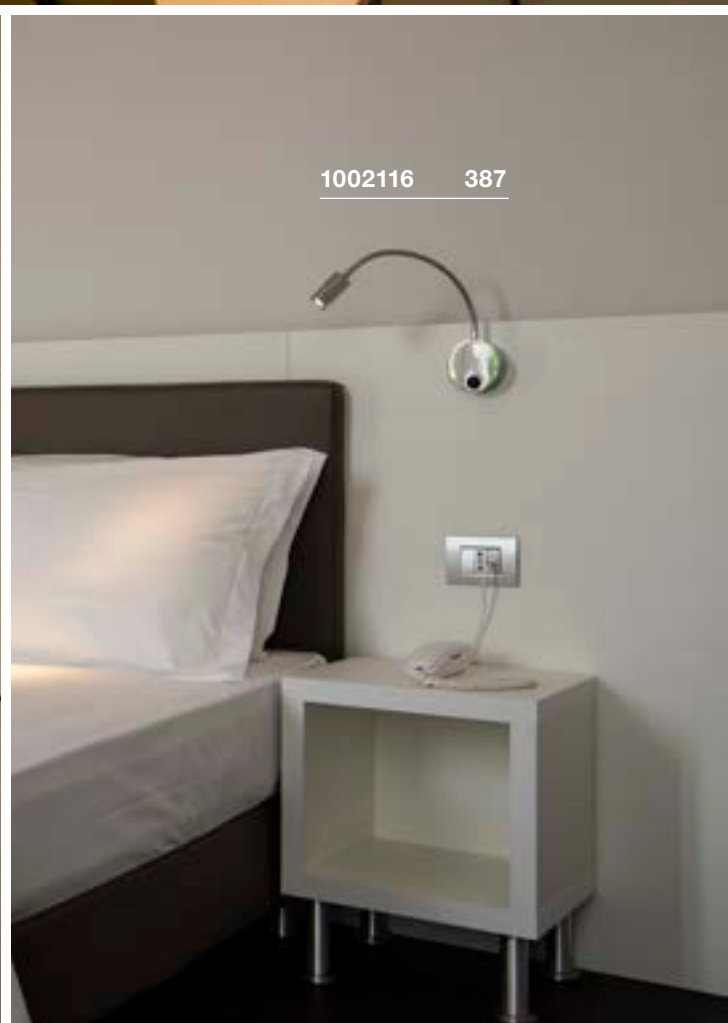

1002116 387



DIO FLEX PLATE WL QPAR51

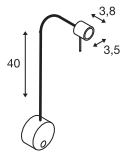

220-240V ~50/60Hz
Matière : aluminium

- Interrupteur sur le boîtier du luminaire
- Anneau décoratif inclus



Douille : 1xGU10

Variante	Réf.	CHF
● noir	1002608	74.00
○ blanc	1002607	74.00
● chrome	146692	85.00



LED GU10 51mm | 6W | 38°
2700K | 450lm | CEE=F
6kWh / 1000h



Réf. : 1005077 | 10.60 CHF

DIO FLEX PLATE WL

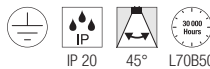
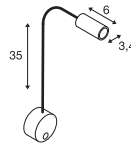

100-240V ~50/60Hz | 350mA
Puissance totale : 1,9W
Matière : aluminium / verre

- Interrupteur sur le boîtier du luminaire



Down 100lm | 2700K
3000K
4000K

Variante	Réf.	CHF
● noir		
2700K	1002430	128.00
○ blanc		
2700K	1002117	128.00
● noir		
3000K	1002431	128.00
○ blanc		
3000K	1002118	128.00
● noir		
4000K	1002432	128.00
○ blanc		
4000K	1002119	128.00

DIO FLEX PLATE WL

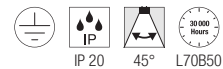
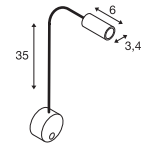

100-240V ~50/60Hz | 350mA
Puissance totale : 1,9W
Matière : aluminium / verre

- Interrupteur sur le boîtier du luminaire



Down 100lm | 2700K
3000K

Variante	Réf.	CHF
● chrome		
2700K	1002116	134.00
● chrome		
3000K	146682	134.00

PHELIA
WL, QPAR51

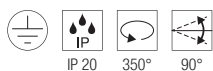
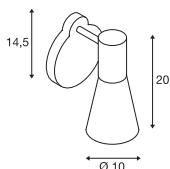

220-240V ~50/60Hz
Matière : aluminium / acier

- Interrupteur sur la tête de lampe



Douille : 1xGU10 Ø max. : 5,1 cm L : 10,5 cm

Variante	Réf.	CHF
● noir	148540	160.00



LED GU10 51mm | 6W | 38°
2700K | 450lm | CEE=F
6kWh / 1000h



Réf. : 1005077 | 10.60 CHF

MERADO FLOOD
WL, PHASE

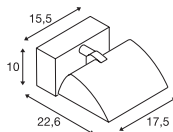

220-240V ~50/60Hz | 1000mA
Puissance totale : 40W
Matière : aluminium



Down 3000lm | 3000K
3200lm | 4000K

Variante	Réf.	CHF
○ blanc 3000lm 3000K	1001468	289.00
○ blanc 3200lm 4000K	1001472	289.00



148540 388



1001468 388



DISPLAY ADL 50
QPAR51

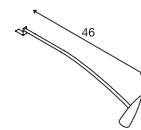

1002860 389



220-240V ~50/60Hz
Matière : aluminium / laiton

- Câble nu
- Boîtier de raccordement inclus

SOCKET INSIDE <50 W

Douille : 1xGU10

Variante	Réf.	CHF
○ blanc	1002860	55.00
● chrome	146332	64.00



LED GU10 51mm | 6W | 36°
2200-2700K | 360lm | CEE=G
6kWh / 1000h



Réf. : 1005273 | 12.90 CHF



Retrouvez les **NUMINOS®** dans les pages familles 98–101

LED

NEW



Retrouvez les **MEDO®** dans les pages familles 148–163

LED



Retrouvez les **ONE®** dans les pages familles 192–193

LED

NEW



SCKET
PANTILO ROPE 19 | 393

NEW



SCKET
PANTILO ROPE 27 | 393

NEW



LED
CYFT | 395

NEW



SCKET
ASTO TUBE | 395

NEW



SCKET
ASTO TUBE | 397

NEW



SCKET
ASTO TUBE | 397

NEW



SCKET
ASTO TUBE | 399

NEW



SCKET
ASTO TUBE | 397



LED
OCULUS | 399



LED
KARPO 30 | 399



LED
NOBLO® | 401



LED
NOBLO® | 401



LED
NOBLO® | 401



LED
KALU | 403



LED
KALU | 403



LED
KALU | 403



LED
KALU | 403



SCKET
KALU | 405



SCKET
KALU | 405



SCKET
KALU | 405



SCKET
KALU | 405



SCKET
ENOLA B | 407



SCKET
ENOLA B | 407



SCKET
ENOLA B | 407



SCKET
ALTRA DICE | 408



SCKET
SPOT 79 | 409



SCKET
INDA | 409



SCKET
PURI | 411



SCKET
PURI | 411



SCKET
PURI | 411



SCKET
PURI | 411



SCKET
AVO | 413



SCKET
AVO | 413



SCKET
AVO | 413



SCKET
AVO | 413



SCKET
AVO | 415



SCKET
ASTO | 415



SCKET
ASTO | 415



SCKET
ASTO | 415



LED
SENSER 12 | 417



LED
SENSER 18 | 417



LED
SENSER 24 | 417



LED
SENSER 12 | 419



LED
SENSER 18 | 419



LED
SENSER 24 | 419



LED
SIMA | 420



LED
SIMA | 420



LED
SIMA | 421

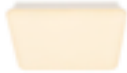

LED
SIMA | 421



LED
LIPSY® 30 | 423



LED
LIPSY® 40 | 423



LED
LIPSY® 50 | 423



LED
LIPSY® 30 | 425



LED
LIPSY® 40 | 425



LED
LIPSY® 50 | 425



LED
LIPSY® 40 | 426



LED
LIPSY® 50 | 426



SCKET
MELAN | 427



SCKET
GLASSA | 427



LED
BATTEN 60 | 429



LED
BATTEN 120 | 429



LED
LONG GRILL | 430



LED
SIGHT 60 | 431



LED
SIGHT 115 | 431



LED
BENA 120 | 433



LED
BENA 150 | 433



1007591 393

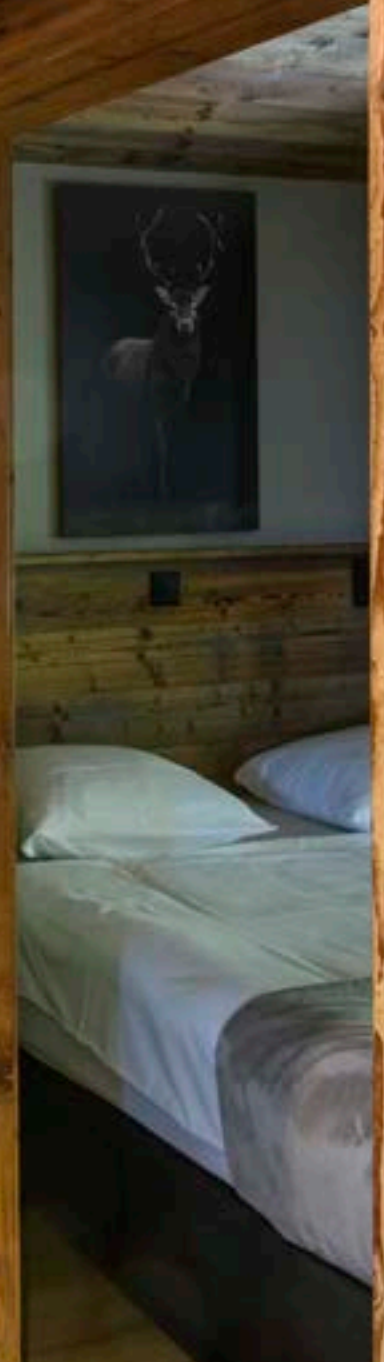



PANTILO ROPE 19 CW, E27

PANTILO ROPE 27 CW, E27

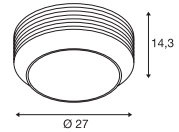
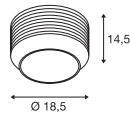

200-240V ~50/60Hz
Matière : verre / acier / chanvre

200-240V ~50/60Hz
Matière : verre / acier / chanvre



Douille : 1xE27 Ø max. : 10 cm L : 11 cm

Douille : 1xE27 Ø max. : 15 cm L : 11 cm

Variante	Réf.	CHF
● ambre / or	1007592	182.90
● anthracite / argent	1007593	182.90

Variante	Réf.	CHF
● ambre / or	1007591	228.90
● anthracite / argent	1007590	228.90



A60 | 7,5W | 180°
2700K | 720lm | CEE=F
8kWh / 1000h



Réf. : **1005305** | **24.50 CHF**



A60 | 7,5W | 180°
2700K | 720lm | CEE=F
8kWh / 1000h



Réf. : **1005305** | **24.50 CHF**

1006439 395





CYFT CW



NEW

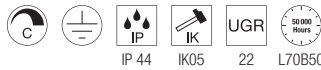
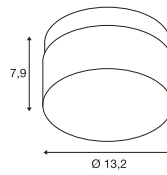

220-240V ~50/60Hz | 500mA
Puissance totale : 6,5W
Matière : aluminium



330lm | 2700K | 350lm | 3000K | 380lm | 4000K

Variante	Réf.	CHF
● noir	1007608	229.00

ASTO TUBE CL, simple, GU10



NEW

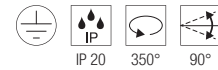
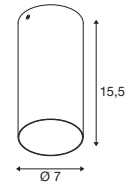

220-240V ~50/60Hz
Matière : aluminium



Douille : 1xGU10

Variante	Réf.	CHF
● noir	1006439	62.50
○ blanc	1006440	62.50

CYFT Anneau décoratif



NEW

H: 2.45 cm
Ø: 13.10 cm
Matière : acier

Variante	Réf.	CHF
○ blanc	1007611	20.70
● laiton	1007610	34.50
● chrome	1007609	28.80

ASTO TUBE Réflecteur décoratif



NEW

H : 3,95 cm
Ø : 6,75 cm
Matière : polycarbonate (PC)

Variante	Réf.	CHF
● noir / chrome	1007190	5.20
● or	1006450	5.20
● chrome	1006449	5.20
● cuivre	1006451	5.20

1006423 397



1006428 397

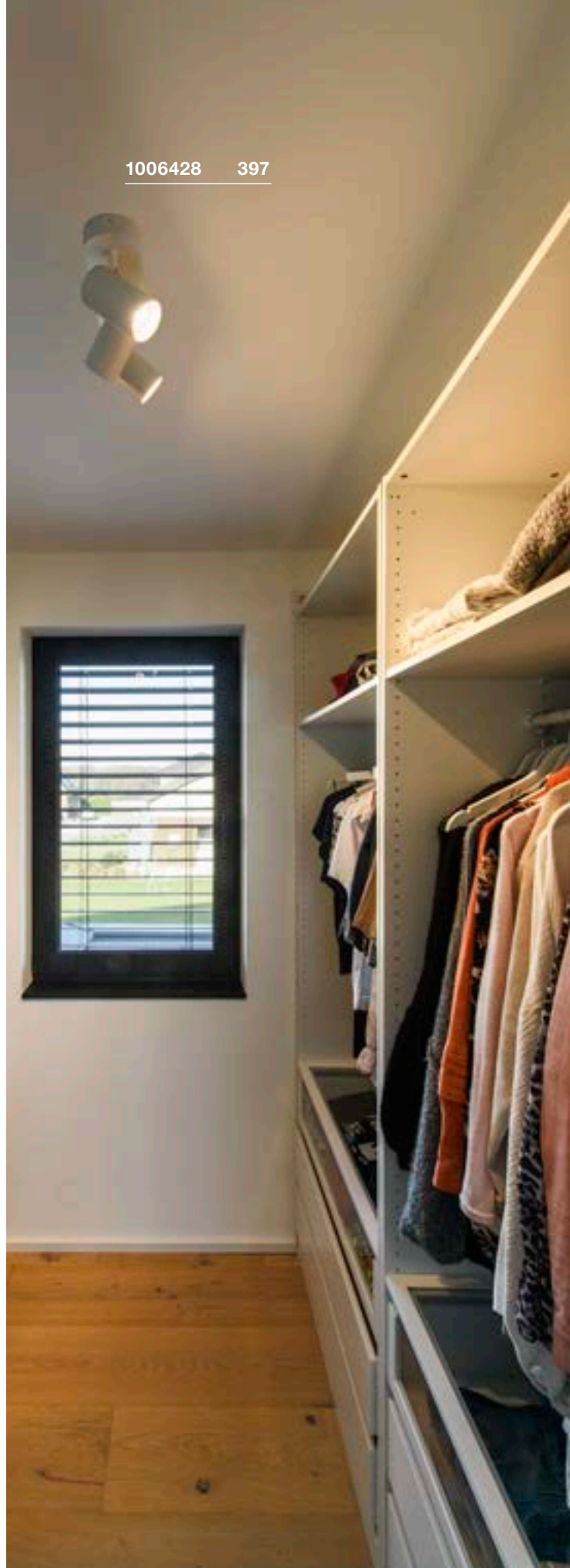



ASTO TUBE

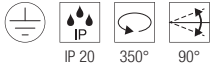

220-240V ~50/60Hz
Matière : aluminium



Douilles : 2xGU10



LED GU10 | 6W | 38°
2700K | 450lm | CEE=F
6kWh / 1000h



Réf. : 1005076 | 10.60 CHF

ASTO TUBE CW, simple, GU10

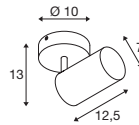

ASTO TUBE CW, double, GU10

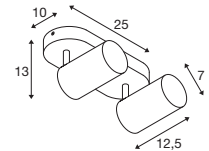

Variante	Réf.	CHF
● noir	1006423	62.50
○ blanc	1006424	62.50

Variante	Réf.	CHF
● noir	1006425	118.00
○ blanc	1006426	118.00

ASTO TUBE Réflecteur décoratif



H : 3,95 cm
Ø : 6,75 cm
Matière : polycarbonate (PC)

ASTO TUBE CW, triple, GU10

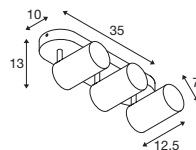

ASTO TUBE CW, quadruple, GU10

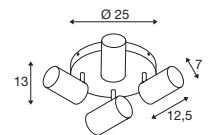

Variante	Réf.	CHF
● noir / chrome	1007190	5.20
● or	1006450	5.20
● chrome	1006449	5.20
● cuivre	1006451	5.20

Variante	Réf.	CHF
● noir	1006427	168.00
○ blanc	1006428	168.00

Variante	Réf.	CHF
● noir	1006429	205.00
○ blanc	1006430	205.00



1004664 399

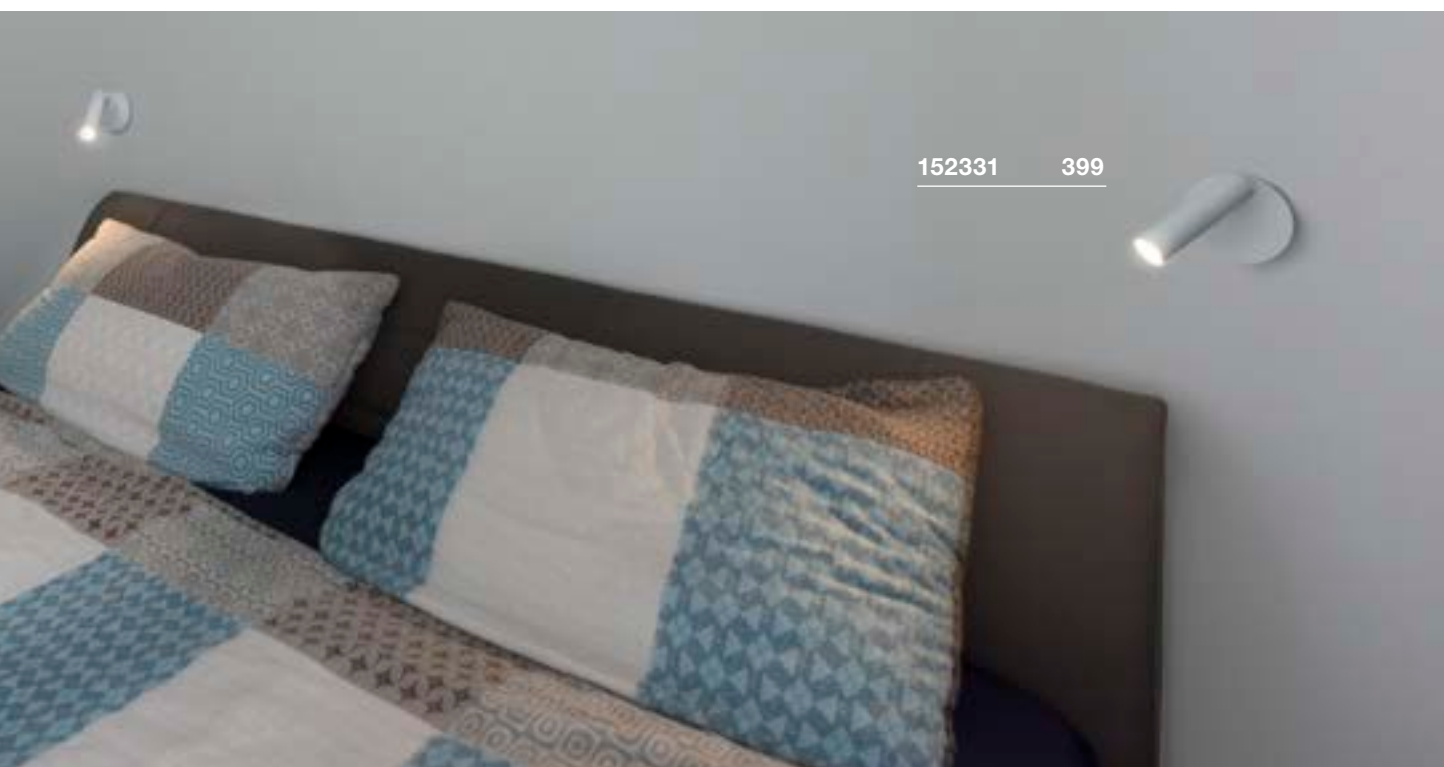

152331 399



OCULUS CW, PHASE

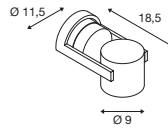

220-240V ~50/60Hz | 250mA
Puissance totale : 11W
Matière : aluminium / verre

- Réflecteur dépoli supplémentaire inclus



Down 36lm | 2000K - 780lm | 3000K

Variante	Réf.	CHF
● noir	1004664	339.00
○ blanc	1004665	339.00

KARPO 30 CW, simple

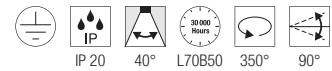
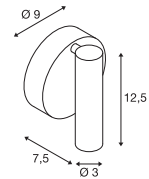

220-240V ~50/60Hz | 500mA
Puissance totale : 9,3W
Matière : aluminium / acier



Down 560lm | 680lm | 3000K

Variante	Réf.	CHF
● noir	560lm	152330
○ blanc	680lm	152331
		160.00
		160.00



1002974 401





NOBLO®

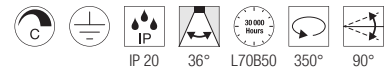

220-240V ~50/60Hz | 350mA
 Puissance totale : 8W
 Matière : aluminium



Down	620lm	2700K
	1240lm	
	1860lm	

NOBLO®
 CW, simple, PHASE

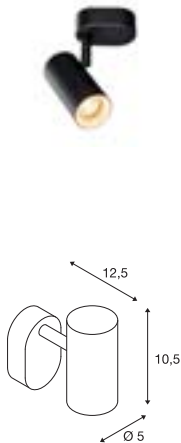

Variante	Réf.	CHF
● noir		
620lm 2700K 8W	1002969	138.00
○ blanc		
620lm 2700K 8W	1002970	138.00
● argent		
620lm 2700K 8W	1002971	138.00

NOBLO®
 CW, double, PHASE

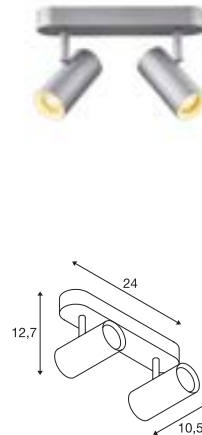

Variante	Réf.	CHF
● noir		
1240lm 2700K 8W	1002973	219.00
○ blanc		
1240lm 2700K 8W	1002974	219.00
● argent		
1240lm 2700K 8W	1002975	219.00

NOBLO®
 CW, triple, PHASE

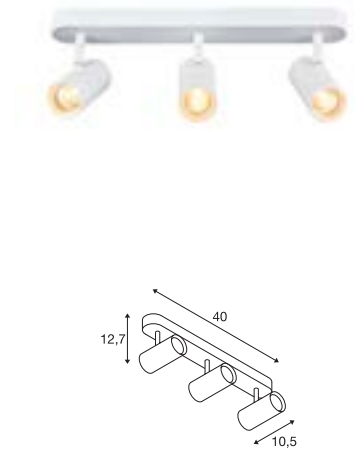

Variante	Réf.	CHF
● noir		
1860lm 2700K 8W	1002976	329.00
○ blanc		
1860lm 2700K 8W	1002977	329.00
● argent		
1860lm 2700K 8W	1002978	329.00

1000131 403





KALU

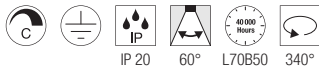

220-240V ~50/60Hz | 350mA
 Puissance totale : 17W
 Matière : aluminium / polycarbonate (PC)



Down

1000lm | 3000K
 2000lm | 3000K
 3000lm | 3000K
 4000lm | 3000K

KALU CW, simple, PHASE

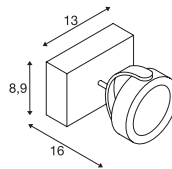

Variante	Réf.	CHF
● noir 1000lm 3000K 17W	1000127	209.00
○ blanc 1000lm 3000K 17W	1000128	209.00

KALU CW, double, PHASE

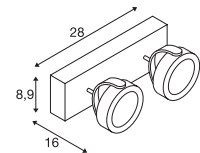

Variante	Réf.	CHF
● noir 2000lm 3000K 17W	1000129	339.00
○ blanc 2000lm 3000K 17W	1000130	339.00

KALU CW, triple, PHASE

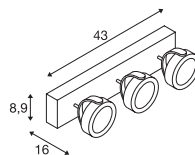

Variante	Réf.	CHF
● noir 3000lm 3000K 17W	1000131	519.00
○ blanc 3000lm 3000K 17W	1000132	519.00

KALU CW, quad, PHASE

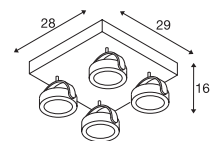

Variante	Réf.	CHF
● noir 4000lm 3000K 17W	1000135	649.00
○ blanc 4000lm 3000K 17W	1000136	649.00

147321 405

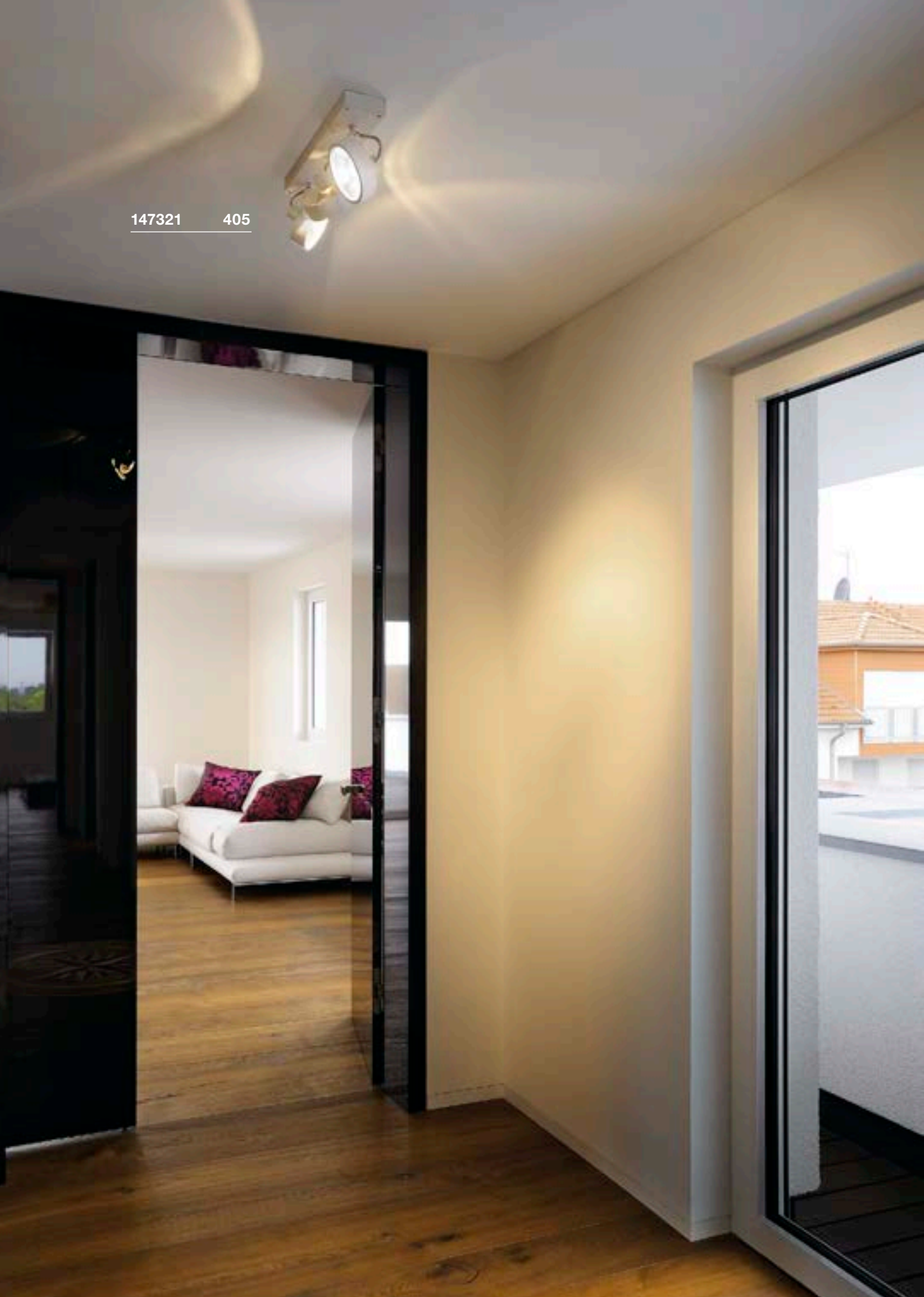



KALU

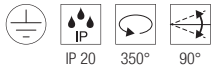

220-240V ~50/60Hz
Matière : aluminium



Douille : 1xGU10



QPAR111 | 8W | 38°
2700K | 680lm | CEE=F
8kWh / 1000h



Réf. : 1005274 | 35.20 CHF

KALU CW, simple, QPAR111

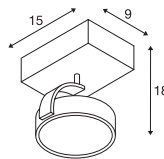

Variante	Réf.	CHF
● noir	1000702	138.00
○ blanc	147301	138.00
● alu brossé	147306	156.00

KALU CW, double, QPAR111

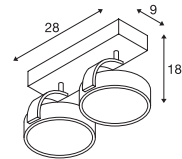

Variante	Réf.	CHF
● noir	1000703	219.00
○ blanc	147311	219.00
● alu brossé	147316	229.00

KALU CW, triple, QPAR111

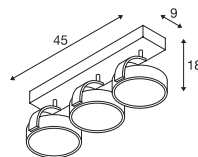

Variante	Réf.	CHF
● noir	1000704	289.00
○ blanc	147321	299.00
● alu brossé	147326	309.00

KALU CW, quad, QPAR111

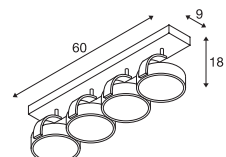

Variante	Réf.	CHF
● noir	1002023	379.00
○ blanc	1002024	379.00
● alu brossé	1002025	389.00



152010 407



ENOLA B
CW, simple, QPAR51

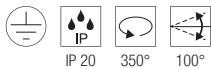
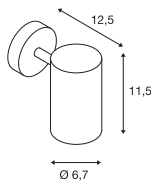

220-240V ~50/60Hz
Matière : aluminium / acier

- Anneau décoratif assorti au coloris du luminaire inclus
- Anneau décoratif noir disponible en option.



Douille : 1xGU10 L max. : 6,7 cm

Variante	Réf.	CHF
● noir	152010	99.00
○ blanc	152011	99.00



LED GU10 51 mm | 6W | 38°
2700K | 450lm | CEE=F
6kWh / 1000h



Réf. : 1005077 | 10.60 CHF



Article	Réf.	CHF
Anneau décoratif		
● noir	151840	12.75

ENOLA B
CW, double, QPAR51

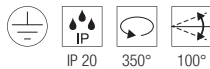
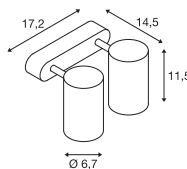

220-240V ~50/60Hz
Matière : aluminium / acier

- Anneau décoratif assorti au coloris du luminaire inclus
- Anneau décoratif noir disponible en option.



Douilles : 2xGU10 L max. : 6,7 cm

Variante	Réf.	CHF
● noir	152020	169.00
○ blanc	152021	169.00



LED GU10 51 mm | 6W | 38°
2700K | 450lm | CEE=F
6kWh / 1000h



Réf. : 1005077 | 10.60 CHF



Article	Réf.	CHF
Anneau décoratif		
● noir	151840	12.75

ENOLA B
CW, double, QPAR51

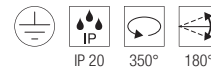
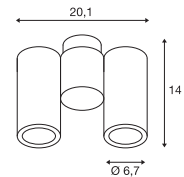

220-240V ~50/60Hz
Matière : aluminium / acier

- Anneau décoratif assorti au coloris du luminaire inclus
- Anneau décoratif noir disponible en option.



Douilles : 2xGU10 L max. : 8 cm

Variante	Réf.	CHF
● noir	151830	209.00
○ blanc	151831	209.00



LED GU10 51 mm | 6W | 38°
2700K | 450lm | CEE=F
6kWh / 1000h



Réf. : 1005077 | 10.60 CHF



Article	Réf.	CHF
Anneau décoratif		
● noir	151840	12.75

1002215 408



ALTRA DICE CW, double, QPAR51

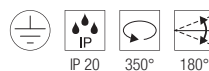
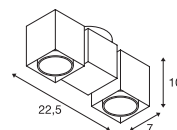

220-240V ~50/60Hz
Matière : aluminium / acier

**SECRET
INSIDE** <50
W

Douilles : 2xGU10

Variante	Réf.	CHF
● noir	1002215	156.00
○ blanc	151531	156.00
● gris	151534	156.00



LED GU10 51 mm | 6W | 36°
2200-2700K | 360lm | CEE=G
6kWh / 1000h



Réf. : 1005273 | 12.90 CHF



147551 409



SPOT 79
CW, QPAR51

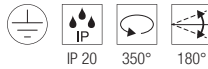
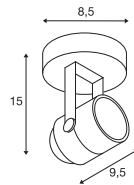

220-240V ~50/60Hz
Matière : aluminium

SOCKET **INSIDE** <50 W

Douille : 1xGU10 Ø max. : 5,1 cm | L : 5,7 cm

Variante	Réf.	CHF
● noir	132020	42.65
○ blanc	132021	42.65
● gris	132024	42.65



LED GU10 51 mm | 6W | 38°
2700K | 450lm | CEE=F
6kWh / 1000h



Réf. : 1005077 | 10.60 CHF

INDA
CW, QPAR51

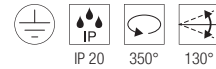
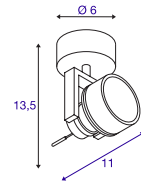

220-240V ~50/60Hz
Matière : aluminium

SOCKET **INSIDE** <50 W

Douille : 1xGU10 Ø max. : 5,1 cm | L : 5,7 cm

Variante	Réf.	CHF
● noir	147550	99.00
○ blanc	147551	99.00
● aluminium	147559	102.00



LED GU10 51 mm | 6W | 38°
2700K | 450lm | CEE=F
6kWh / 1000h



Réf. : 1005077 | 10.60 CHF





PURI

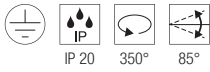

220-240V ~50/60Hz
Matière : aluminium / acier

- Anneau décoratif inclus



Douille : 1xGU10



LED GU10 51 mm | 6W | 38°
2700K | 450lm | CEE=F
6kWh / 1000h



Réf. : 1005077 | 10.60 CHF

PURI
CW, simple, QPAR51

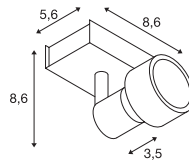

PURI
CW, double, QPAR51

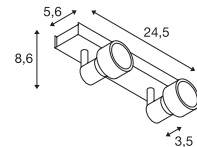

Variante	Réf.	CHF
● noir	147360	48.00
○ blanc	147361	48.00

Variante	Réf.	CHF
● noir	147370	99.00
○ blanc	147371	99.00

PURI
CW, triple, QPAR51

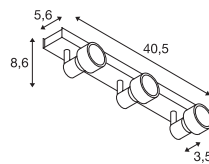

PURI
CW, quad, QPAR51

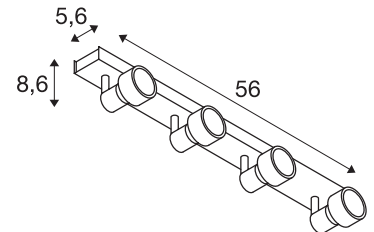

Variante	Réf.	CHF
● noir	147380	128.00
○ blanc	147381	128.00

Variante	Réf.	CHF
● noir	1002029	209.00
○ blanc	1002030	209.00

1000892 413



101

102



AVO

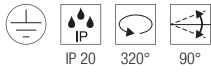

220-240V ~50/60Hz
Matière : acier



Douille : 1xGU10



LED GU10 51 mm | 6W | 38°
2700K | 450lm | CEE=F
6kWh / 1000h



Réf. : 1005077 | 10.60 CHF

AVO CW, simple, QPAR51

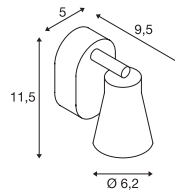

AVO CW, double, QPAR51

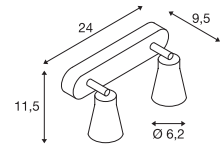

Variante	Réf.	CHF
● noir	1000886	56.00
○ blanc	1000887	56.00

Variante	Réf.	CHF
● noir	1000889	117.00
○ blanc	1000890	117.00

AVO CW, triple, QPAR51

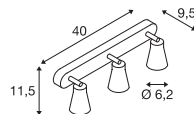

AVO CW, quad, QPAR51

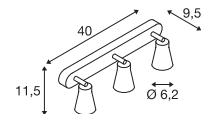

Variante	Réf.	CHF
● noir	1000892	149.00
○ blanc	1000893	149.00

Variante	Réf.	CHF
● noir	1000895	172.00
○ blanc	1000896	172.00



147443

415





ASTO

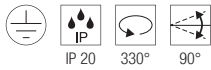

220-240V ~50/60Hz
Matière : aluminium



Douille : 1xGU10



LED GU10 51 mm | 6W | 38°
2700K | 450lm | CEE=F
6kWh / 1000h



Réf. : 1005075 | 10.60 CHF

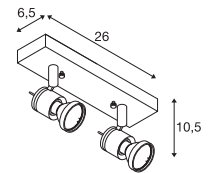
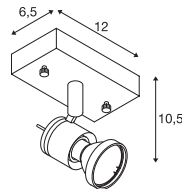

Variante	Réf.	CHF
● alu brossé	147441	42.65

Variante	Réf.	CHF
● alu brossé	147442	96.00

ASTO CW, triple, QPAR51

ASTO CW, quad, QPAR51

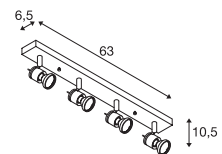
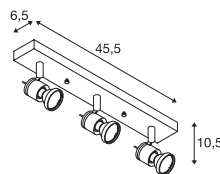

Variante	Réf.	CHF
● alu brossé	147443	117.00

Variante	Réf.	CHF
● alu brossé	147444	149.00

1004705 417

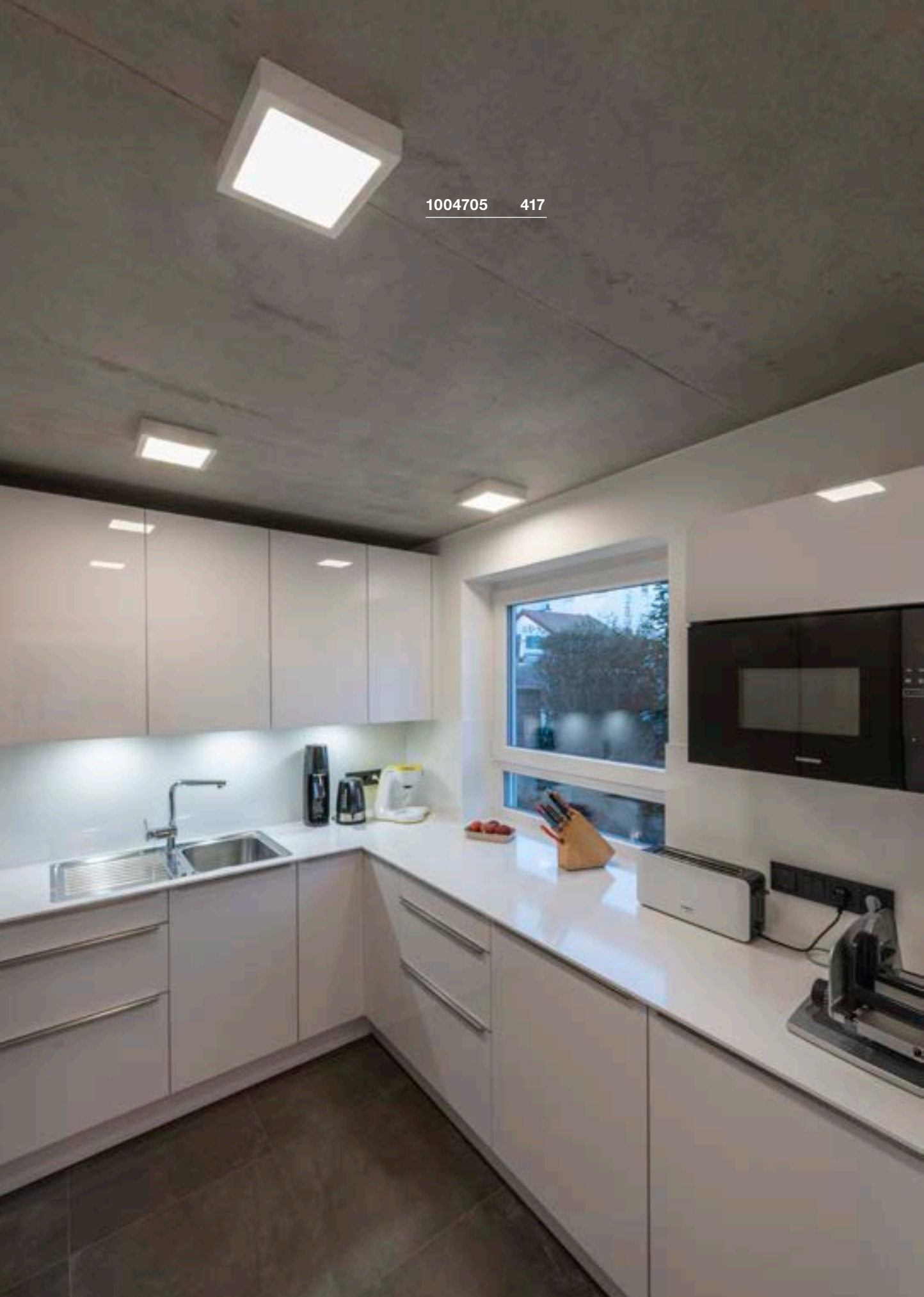



SENSER 12
CW, carré, PHASE

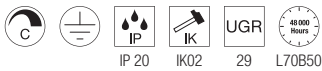
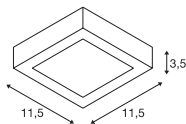

220-240V ~50/60Hz | 200mA
Puissance totale : 8,4W
Matière : aluminium



Down 460lm | 3000K

Variante	Réf.	CHF
<input type="radio"/> blanc	1003017	95.00

SENSER 18
CW, carré, PHASE

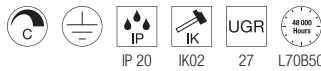
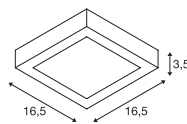

220-240V ~50/60Hz | 350mA
Puissance totale : 13W
Matière : aluminium



Down 840lm | 3000K

Variante	Réf.	CHF
<input type="radio"/> blanc	1003018	116.00

SENSER 24
CW, carré, PHASE

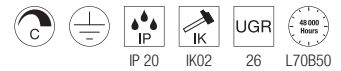
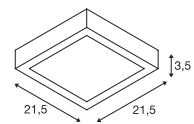

220-240V ~50/60Hz | 500mA
Puissance totale : 15W
Matière : aluminium



Down 1140lm | 3000K
1240lm | 4000K

Variante	Réf.	CHF
<input type="radio"/> blanc		
1140lm 3000K	1003019	117.00
<input type="radio"/> blanc		
1240lm 4000K	1004705	106.00





SENER 12
CW, rond, PHASE

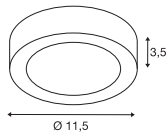

220-240V ~50/60Hz | 200mA
Puissance totale : 8,4W
Matière : aluminium



Down 460lm | 3000K
470lm | 4000K

Variante	Réf.	CHF
○ blanc 460lm 3000K 8.4W	1003014	95.00
○ blanc 470lm 4000K 8.2W	1004700	96.00

SENER 18
CW, rond, PHASE

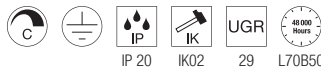
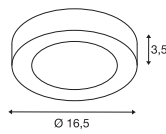

220-240V ~50/60Hz | 350mA
Puissance totale : 13W
Matière : aluminium



Down 830lm | 3000K
990lm | 4000K

Variante	Réf.	CHF
○ blanc 830lm 3000K 13W	1003015	117.00
○ blanc 990lm 4000K 12W	1004701	99.00

SENER 24
CW, rond, PHASE

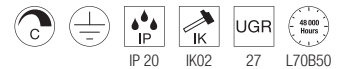
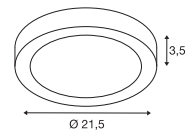

220-240V ~50/60Hz | 500mA
Puissance totale : 15W
Matière : aluminium



Down 1140lm | 3000K
1300lm | 4000K

Variante	Réf.	CHF
○ blanc 1140lm 3000K	1003016	117.00
○ blanc 1300lm 4000K	1004702	106.00

SIMA
CW, rond, Sensor

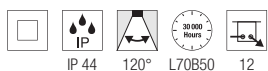
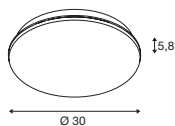

220-240V ~50/60Hz | 320mA
Puissance totale : 24W
Matière : polycarbonate (PC)



Down 2200lm | 3000K

Variante	Réf.	CHF
○ blanc	1005086	202.00

SIMA
CW, rond, PHASE

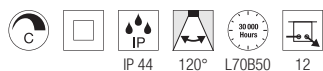
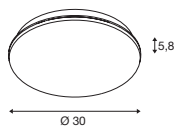

220-240V ~50/60Hz | 320mA
Puissance totale : 24W
Matière : polycarbonate (PC)



Down 2200lm | 3000K

Variante	Réf.	CHF
○ blanc	1005085	179.00

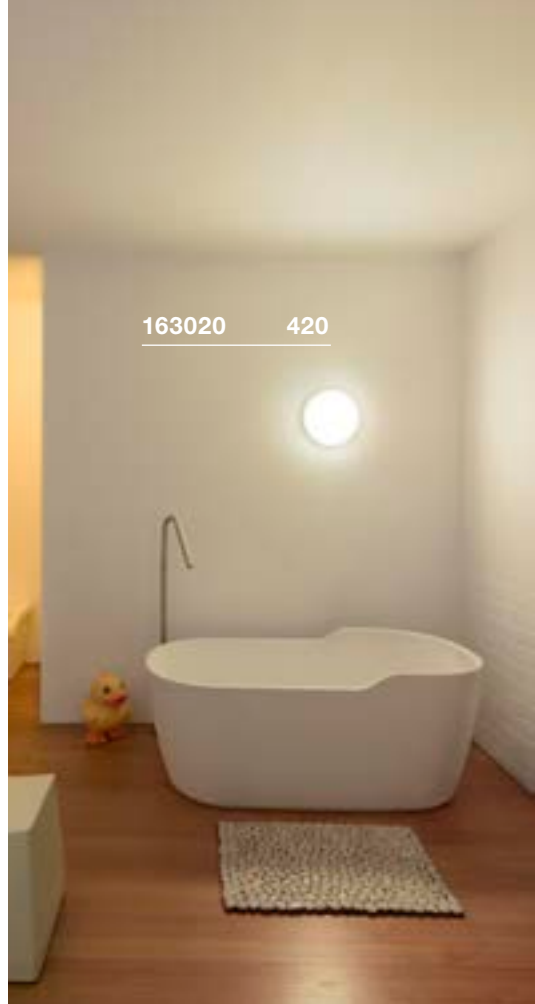

163020 420

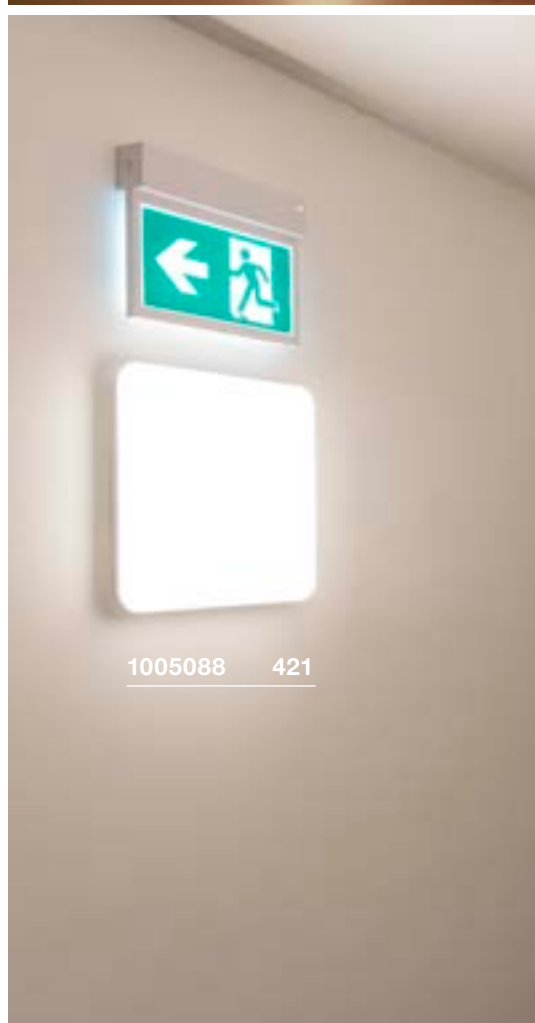

1005088 421

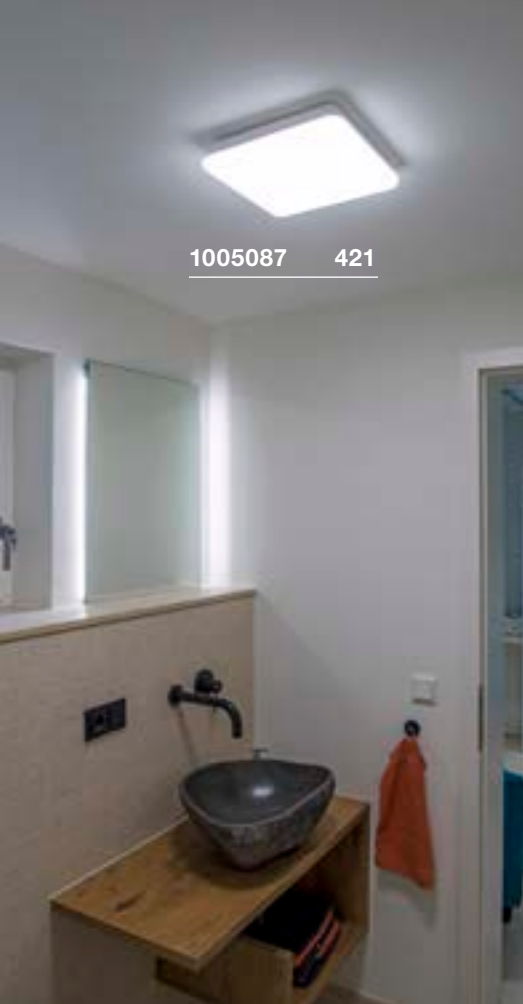

1005087 421

SIMA
CW, carré, Sensor

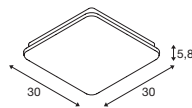

220-240V ~50/60Hz | 320mA
Puissance totale : 24W
Matière : polycarbonate (PC)



Down 2200lm | 3000K

Variante	Réf.	CHF
○ blanc	1005088	202.00

SIMA
CW, carré, PHASE

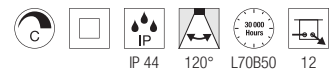
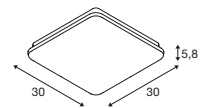

220-240V ~50/60Hz | 320mA
Puissance totale : 24W
Matière : polycarbonate (PC)



Down 2200lm | 3000K

Variante	Réf.	CHF
○ blanc	1005087	179.00



1002021 423





LIPSY® 30
CW, Dome

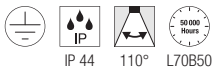
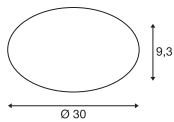
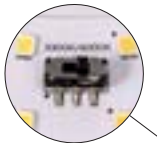

220-240V ~50/60Hz | 350mA
Puissance totale : 13,5W
Matière : aluminium / polycarbonate (PC)



Down 1550lm | 3000K | 1600lm | 4000K

Variante	Réf.	CHF
○ blanc	1002020	117.00

LIPSY® 40
CW, Dome

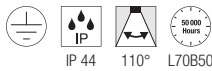
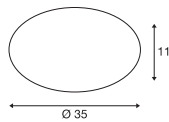
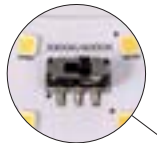

220-240V ~50/60Hz | 500mA
Puissance totale : 17,5W
Matière : aluminium / polycarbonate (PC)



Down 2050lm | 3000K | 2200lm | 4000K

Variante	Réf.	CHF
○ blanc	1002021	138.00

LIPSY® 50
CW, Dome

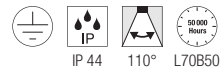
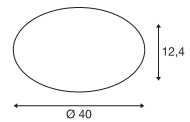

220-240V ~50/60Hz | 500mA
Puissance totale : 20W
Matière : aluminium / polycarbonate (PC)



Down 2500lm | 3000K | 2700lm | 4000K

Variante	Réf.	CHF
○ blanc	1002022	160.00

1002076 425





LIPSY® 30
CW, Drum

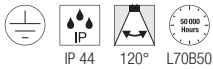
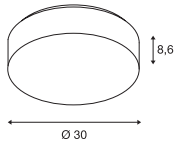
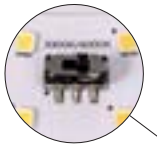

220-240V ~50/60Hz | 350mA
Puissance totale : 13,5W
Matière : aluminium / polycarbonate (PC)



Down 1600lm | 3000K | 1650lm | 4000K

Variante	Réf.	CHF
○ blanc	1002075	127.00

LIPSY® 40
CW, Drum

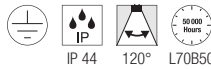
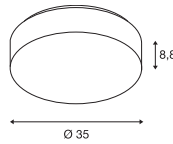
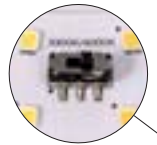

220-240V ~50/60Hz | 500mA
Puissance totale : 17,5W
Matière : aluminium / polycarbonate (PC)



Down 2100lm | 3000K | 2300lm | 4000K

Variante	Réf.	CHF
○ blanc	1002076	138.00

LIPSY® 50
CW, Drum

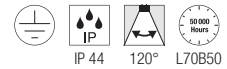
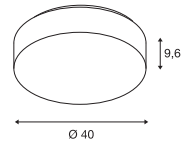
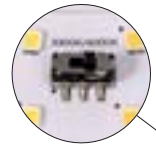

220-240V ~50/60Hz | 500mA
Puissance totale : 20W
Matière : aluminium / polycarbonate (PC)



Down 2450lm | 3000K | 2600lm | 4000K

Variante	Réf.	CHF
○ blanc	1002077	160.00



1002940 426



1002941 426

LIPSY® 40

CW, Drum, DALI

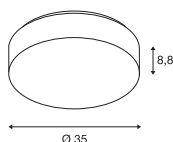
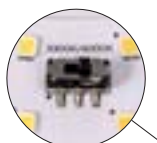

LIPSY® 50

CW, Drum, DALI

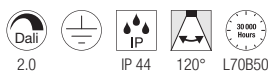
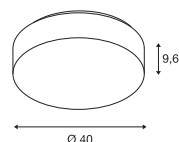
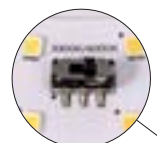

220-240V ~50/60Hz | 500mA
 Puissance totale : 18W
 Matière : aluminium / polycarbonate (PC)



Down 2100lm | 3000K | 2300lm | 4000K

Variante	Réf.	CHF
○ blanc	1002940	239.00

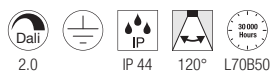

220-240V ~50/60Hz | 500mA
 Puissance totale : 21W
 Matière : aluminium / polycarbonate (PC)



Down 2450lm | 3000K | 2600lm | 4000K

Variante	Réf.	CHF
○ blanc	1002941	249.00



155236 427

MELAN
CW, E27

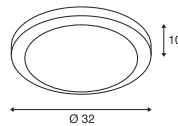

220-240V ~50/60Hz
Matière : aluminium / verre



Douille : 1xE27 Ø max. : 7 cm L : 16 cm

Variante	Réf.	CHF
● alu brossé	155236	125.00



A60 | 7,5W | 320°
2700K | 800lm | CEE=F
8kWh / 1000h



Réf. : 1005303 | 12.90 CHF



220-240V ~50/60Hz
Matière : acier / verre



Douilles : 2xE27 Ø max. : 4,8 cm L : 14,8 cm

Variante	Réf.	CHF
● transparent/chrome	155180	156.00



LED E27 | 8W | 240°
4000K | 920lm | CEE=E
8kWh / 1000h



Réf. : 1005290 | 12.90 CHF



155180 427

GLASSA
CW, carré, E27

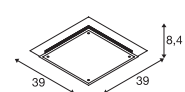

1006124 429





BATTEN 60 CW

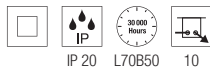
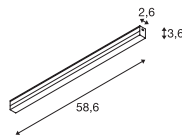

220-240V ~50/60Hz | 110mA
Puissance totale : 9W
Matière : polycarbonate (PC)

- Interrupteur sur le boîtier du luminaire
- Alimentation non incluse



Down 940lm | 3000K | 980lm | 4000K

Variante	Réf.	CHF
<input type="radio"/> blanc	1006123	55.00



Variante	Réf.	CHF
Connecteur direct		
<input type="radio"/> blanc	1006128	3.50
Alimentation		
<input type="radio"/> blanc	1006125	13.50
Patte de montage		
<input type="radio"/> blanc	1006126	3.10
Câble connecteur, longueur 60 cm		
<input type="radio"/> blanc	1006127	7.40

BATTEN 120 CW

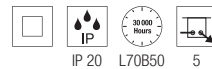
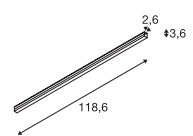

220-240V ~50/60Hz | 220mA
Puissance totale : 18W
Matière : polycarbonate (PC)

- Interrupteur sur le boîtier du luminaire
- Alimentation non incluse



Down 1900lm | 3000K | 1960lm | 4000K

Variante	Réf.	CHF
<input type="radio"/> blanc	1006124	77.00



Article	Réf.	CHF
Connecteur direct		
<input type="radio"/> blanc	1006128	3.50
Alimentation		
<input type="radio"/> blanc	1006125	13.50
Patte de montage		
<input type="radio"/> blanc	1006126	3.10
Câble connecteur, longueur 60 cm		
<input type="radio"/> blanc	1006127	7.40

LONG GRILL
CW

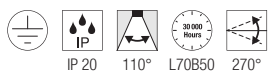
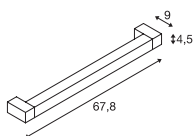

220-240V ~50/60Hz | 700mA
Puissance totale : 20W
Matière : aluminium / acrylique



Down 1600lm | 3000K

Variante	Réf.	CHF
● noir	1001020	359.00
○ blanc	1001019	359.00

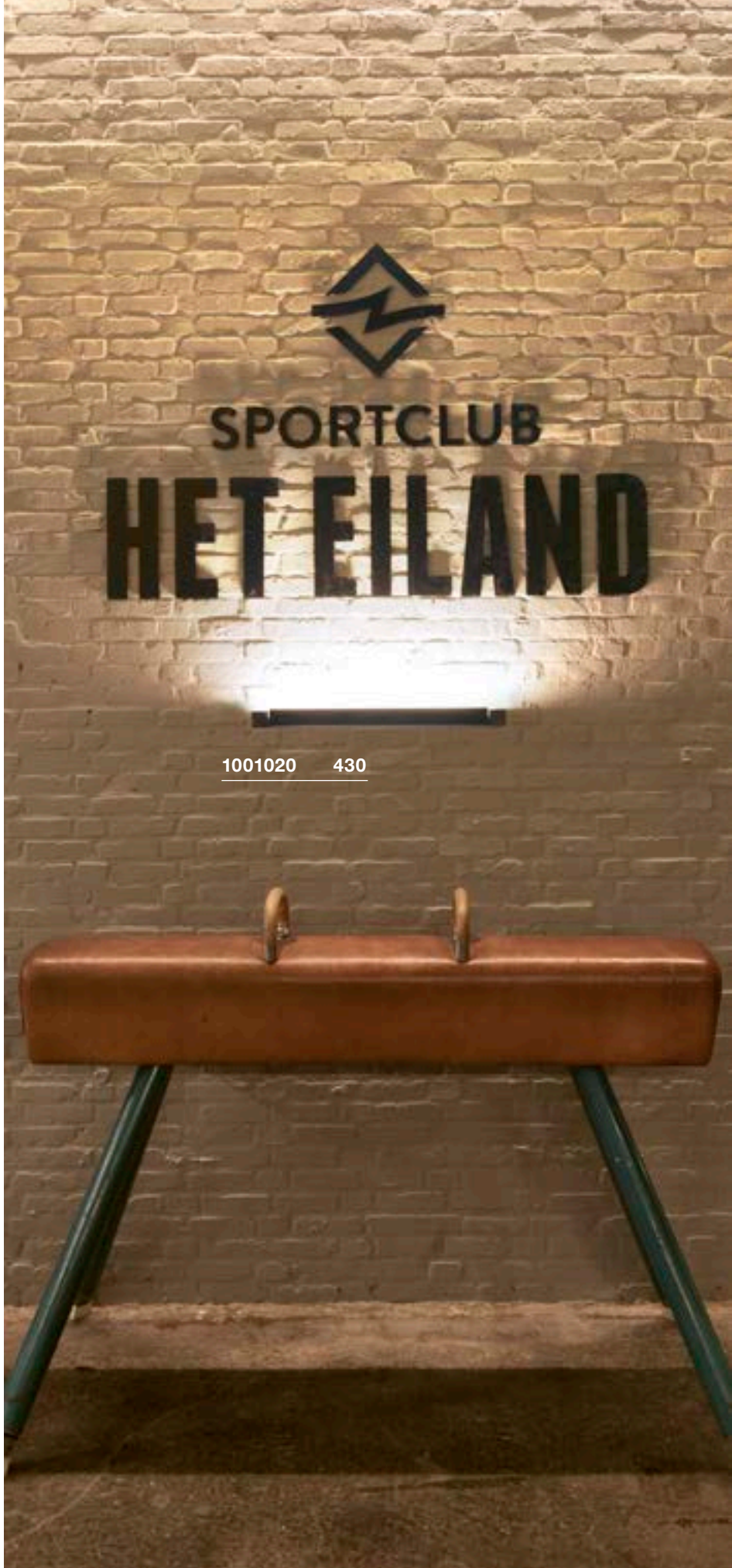

1001020 430



SIGHT 60
CW

SIGHT 115
CW

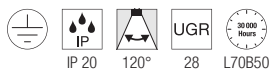
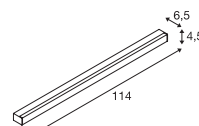
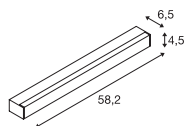
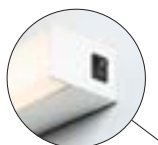

220-240V ~50/60Hz | 700mA
Puissance totale : 20W
Matière : aluminium / acrylique

220-240V ~50/60Hz | 700mA
Puissance totale : 38W
Matière : aluminium / acrylique

- Interrupteur sur le boîtier du luminaire



Down 1490lm | 3000K



Down 3100lm | 3000K

Variante	Réf.	CHF
● noir	1001283	269.00
○ blanc	1001284	269.00

Variante	Réf.	CHF
● noir	1001286	359.00
○ blanc	1001287	359.00

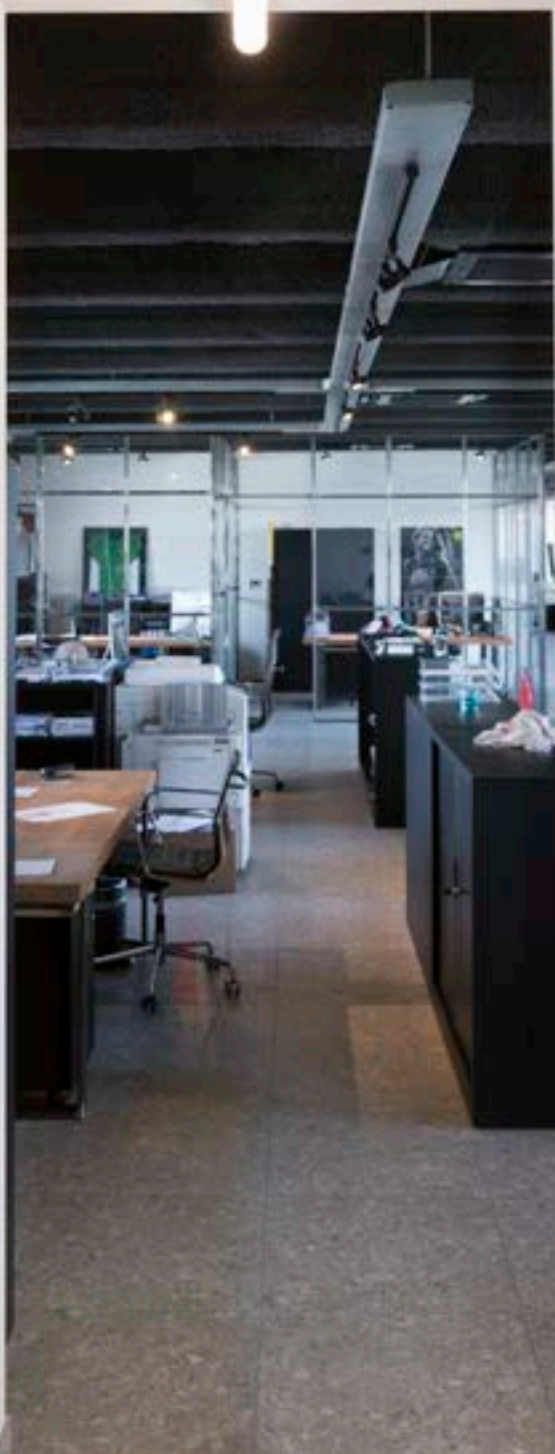



631337 433

BENA 120
CW

BENA 150
CW

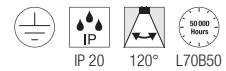
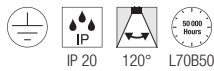
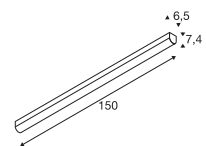
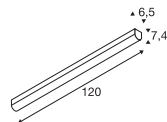

220-240V ~50/60Hz | 700mA
Puissance totale : 28W
Matière : polyméthacrylate de méthyle (PMMA) / acier

220-240V ~50/60Hz | 700mA
Puissance totale : 36W
Matière : polyméthacrylate de méthyle (PMMA) / acier



Down 3800lm | 3000K

Down 5000lm | 3000K

Variante	Réf.	CHF
<input type="radio"/> blanc	631337	209.00

Variante	Réf.	CHF
<input type="radio"/> blanc	631339	249.00



1007697 439



NEW



Retrouvez les ONE® dans les pages familles 196-197

LED

NEW



LED

VINOLINA ONE | 437

NEW



LED

VINOLINA | 437

NEW



LED

VINOLINA TWO | 439

NEW



LED

TAHA | 441

NEW



SCKET

TINY SUN | 443

NEW



SCKET

LITTLE SUN | 443

NEW



SCKET

VARYT | 443

NEW



LED

WORKLIGHT PRO | 444

NEW



LED

WORKLIGHT PRO | 444



LED

WORKLIGHT | 445



LED

WORKLIGHT | 445



SCKET

FENDA | 447



SCKET

FENDA | 447



SCKET

FENDA | 447



SCKET

FENDA | 448



SCKET

FENDA BOW BASIS | 448



FENDA | 448



FENDA | 449



FENDA | 449



FENDA | 449



LED

KARPO | 452



LED

KARPO | 452



SCKET

PHELIA | 453



LED

TONILA | 453



LED

MAGANDA | 453



1007357 437

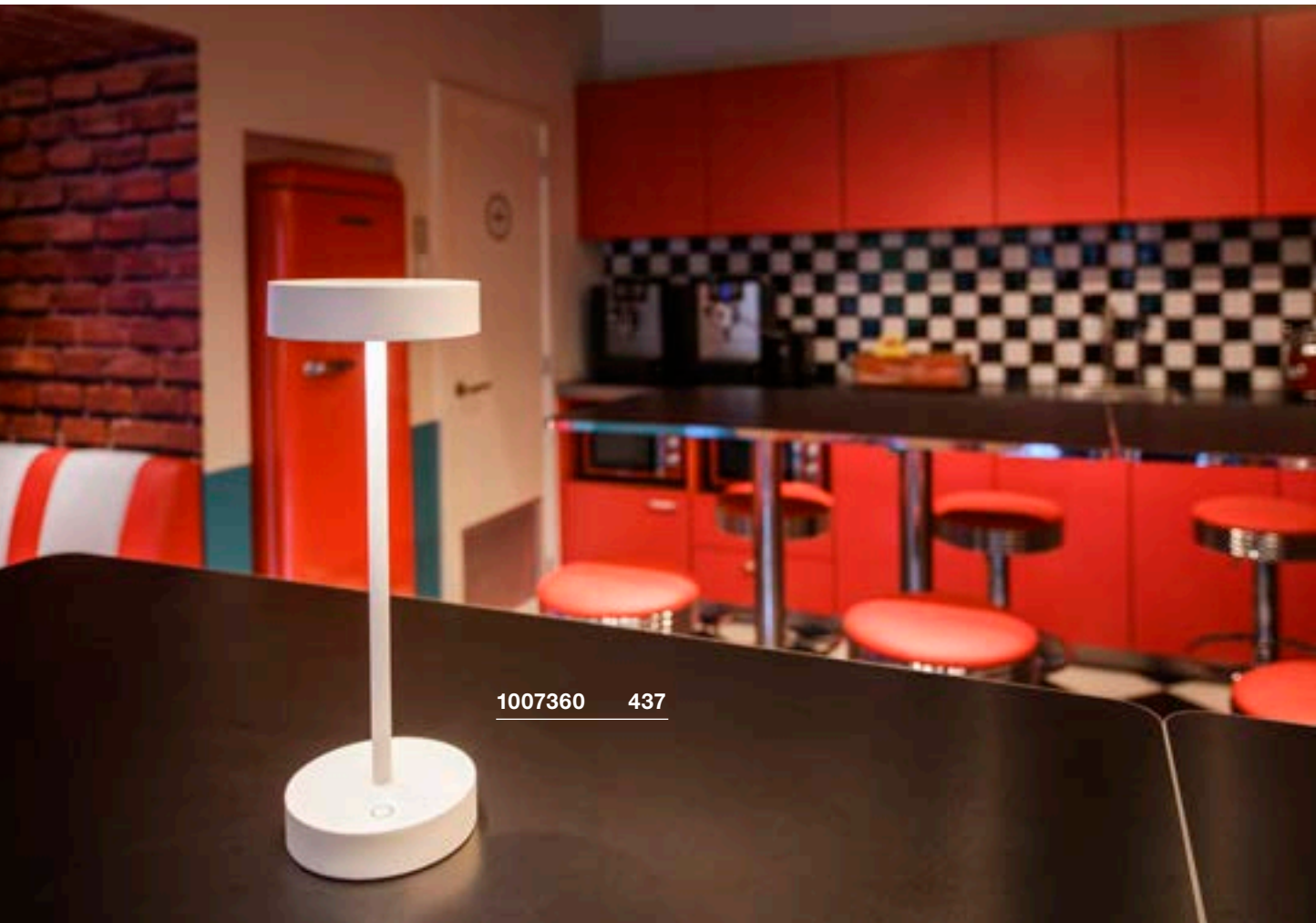

1007360 437



VINOLINA ONE TL, sans fil

VINOLINA TL, sans fil

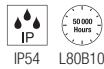
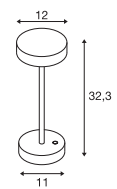
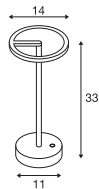
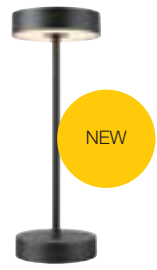
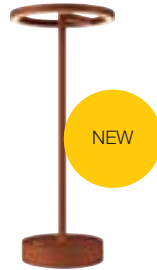

Fonctionne sur batterie 5V
Puissance totale : 2,5W
Matière : aluminium

- Autonomie : 12 h
- Rechargement : 7 h
- Base de chargement incluse
- Alimentation non fournie
- USB A

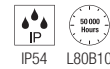

Fonctionne sur batterie 5V
Puissance totale : 2,2W
Matière : aluminium

- Autonomie : 12 h
- Rechargement : 7 h
- Base de chargement incluse
- Alimentation non fournie
- USB A



Down 125lm | 2700K



Down 130lm | 2700K | 130lm | 3000K

Coloris	Ref.	CHF
● noir	1007359	159.90
○ blanc	1007357	159.90
● rouille	1007358	159.90

Coloris	Ref.	CHF
● noir	1007362	159.90
○ blanc	1007360	159.90
● rouille	1007361	159.90



1007692 439



VINOLINA TWO

TL, sans fil

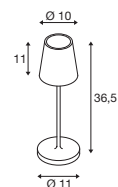

IP65 L70B20

Fonctionne sur batterie 5V

Puissance totale : 2W

Matière : aluminium

- Variation à commande tactile
- Autonomie : 10 h
- Rechargement : 5 h
- Avec station de rechargement pour un luminaire



Down

190lm | 2200K
2700K
3000K

Coloris	Ref.	CHF
● noir	1007693	● 159.90
○ blanc	1007692	● 159.90
● sable	1007697	● 159.90
● rouille	1007695	● 159.90
● rouge	1007694	● 159.90
● vert tilleul	1007696	● 159.90



1007380 441



TAHA

Kit de luminaires, sans fil

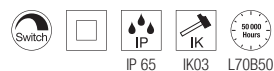

100-240V ~50/60Hz |
 Fonctionnement sur batterie 5V
 Puissance totale : 5W
 Tension de sortie max. driver : 5V DC
 Matière : aluminium / plastique

- Câble de chargement inclus



Down

200lm | 2700K

Coloris	Ref.	CHF
● noir	1007380	● 182.90





1007366 443

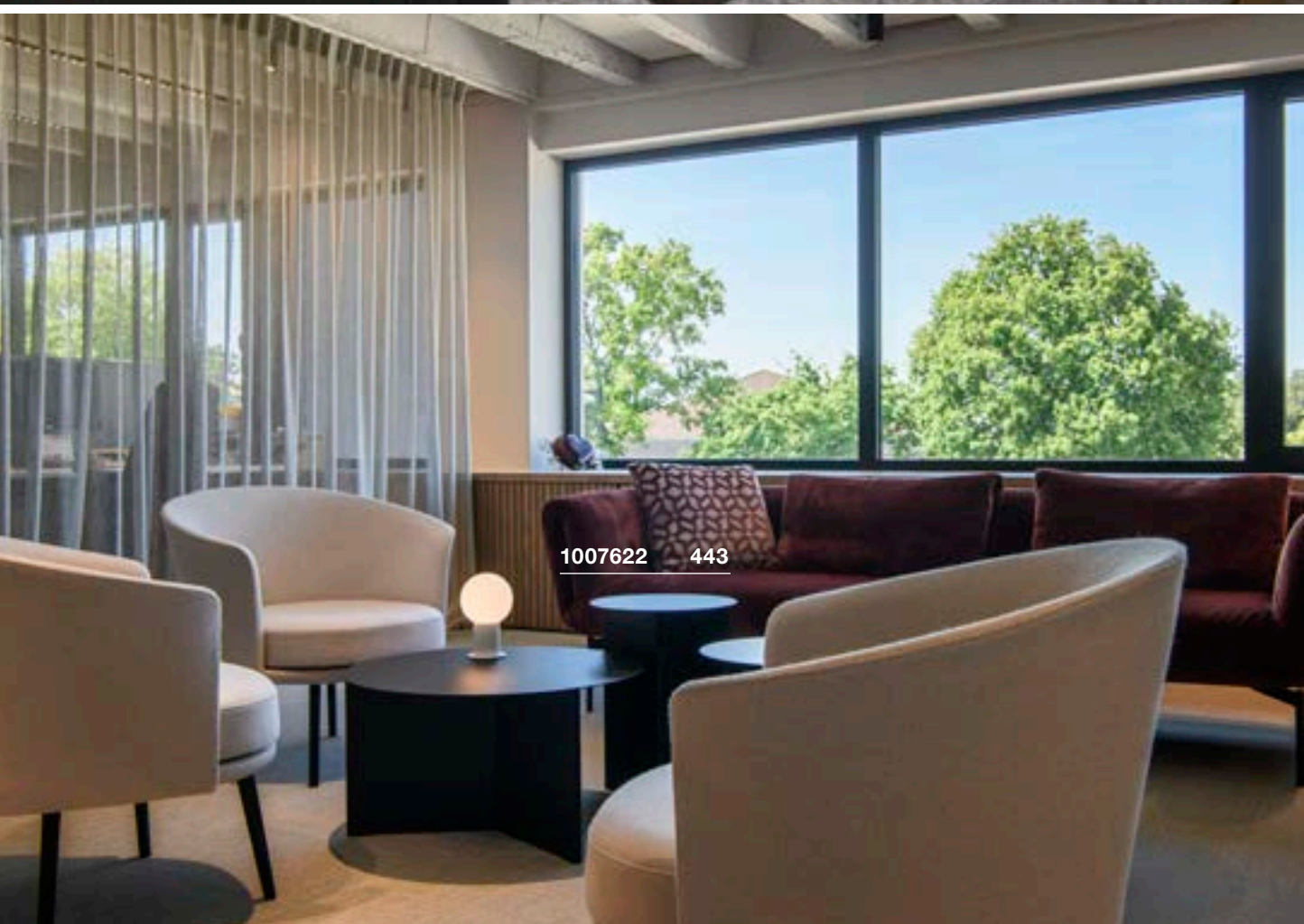

1007622 443



TINY SUN
TL

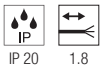
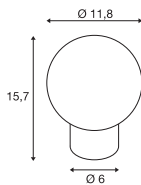

220-240V ~50/60Hz
Matière : acier

- Fiche européenne



Douille : 1xG9 Ø max. : 3 cm L : 6 cm

Coloris	Ref.	CHF
cuivre	1007364	113.90
bronze	1007363	113.90



LED G9 | 3,6W | 300°
3000K | 400lm | CEE=E
4kWh / 1000h

Ref. : 1005286 | 12.90 CHF

LITTLE SUN
TL

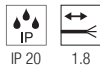
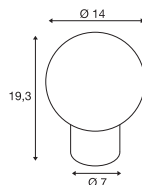

220-240V ~50/60Hz
Matière : acier

- Fiche européenne



Douille : 1xG9 Ø max. : 3 cm L : 6 cm

Coloris	Ref.	CHF
cuivre	1007366	125.40
bronze	1007365	125.40



LED G9 | 3,6W | 300°
3000K | 400lm | CEE=E
4kWh / 1000h

Ref. : 1005286 | 12.90 CHF

VARYT
TL, E14

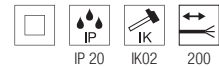
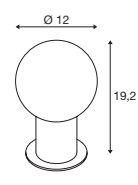

220-240V ~50/60Hz
Matière : aluminium / acier

- Fiche européenne



Douille : 1xE14 Ø max. : 3,8 cm L : 11 cm

Coloris	Ref.	CHF
noir	1007620	166.80
blanc	1007622	166.80
laiton	1007623	207.00
chrome	1007621	184.00



C35 | 4,2W | 320°
2700K | 350lm | CEE=G
5kWh / 1000h

Ref. : 1005285 | 12.90 CHF



WORKLIGHT PRO
FL, simple

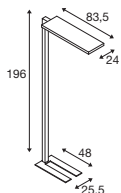
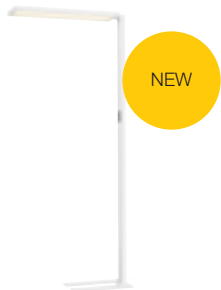

200-240V ~50/60Hz | 48V
Puissance totale : 100W
Matière : aluminium / acier

- Fiche incluse
- Variation à commande tactile



Up 10700lm | 4000K
Down 2300lm

Coloris	Ref.	CHF
● noir	1007462	1'092.50
○ blanc	1007463	1'092.50
● gris	1007464	1'092.50

WORKLIGHT PRO
FL, double

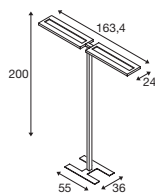
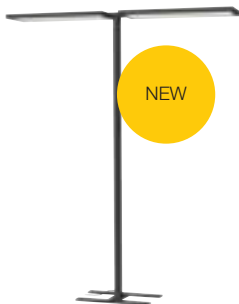

200-240V ~50/60Hz | 48V
Puissance totale : 150W
Matière : aluminium / acier

- Fiche incluse
- Variation à commande tactile



Up 15600lm | 4000K
Down 4400lm

Coloris	Ref.	CHF
● noir	1007465	2'011.40
○ blanc	1007466	2'011.40
● gris	1007467	2'011.40





1006344 445

WORKLIGHT TL

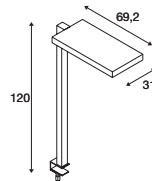

IP 20 IK02 80° 110° UGR 19 L80B10

 250

200-240V ~50/60Hz | 2000mA
 Puissance totale : 79W
 Matière : aluminium

- Plage de serrage : 6-40 mm
- Fiche incluse
- Variation à commande tactile



Up 3800lm | 4000K
 Down 3800lm

Coloris	Ref.	CHF
● noir	1005392	889.00
○ blanc	1005394	889.00
● argent	1006344	869.00

WORKLIGHT FL

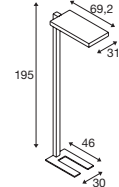

IP 20 IK02 80° 110° UGR 19 L80B10

 250

200-240V ~50/60Hz | 2000mA
 Puissance totale : 79W
 Matière : aluminium

- Fiche incluse
- Variation à commande tactile



Up 3800lm | 4000K
 Down 3800lm

Coloris	Ref.	CHF
● noir	1005390	899.00
○ blanc	1005391	899.00
● argent	1006343	959.00



1005391 445



132660 + 1000580 296 + 449

155790 + 155592 447 + 449

155780 + 155592 447 + 449

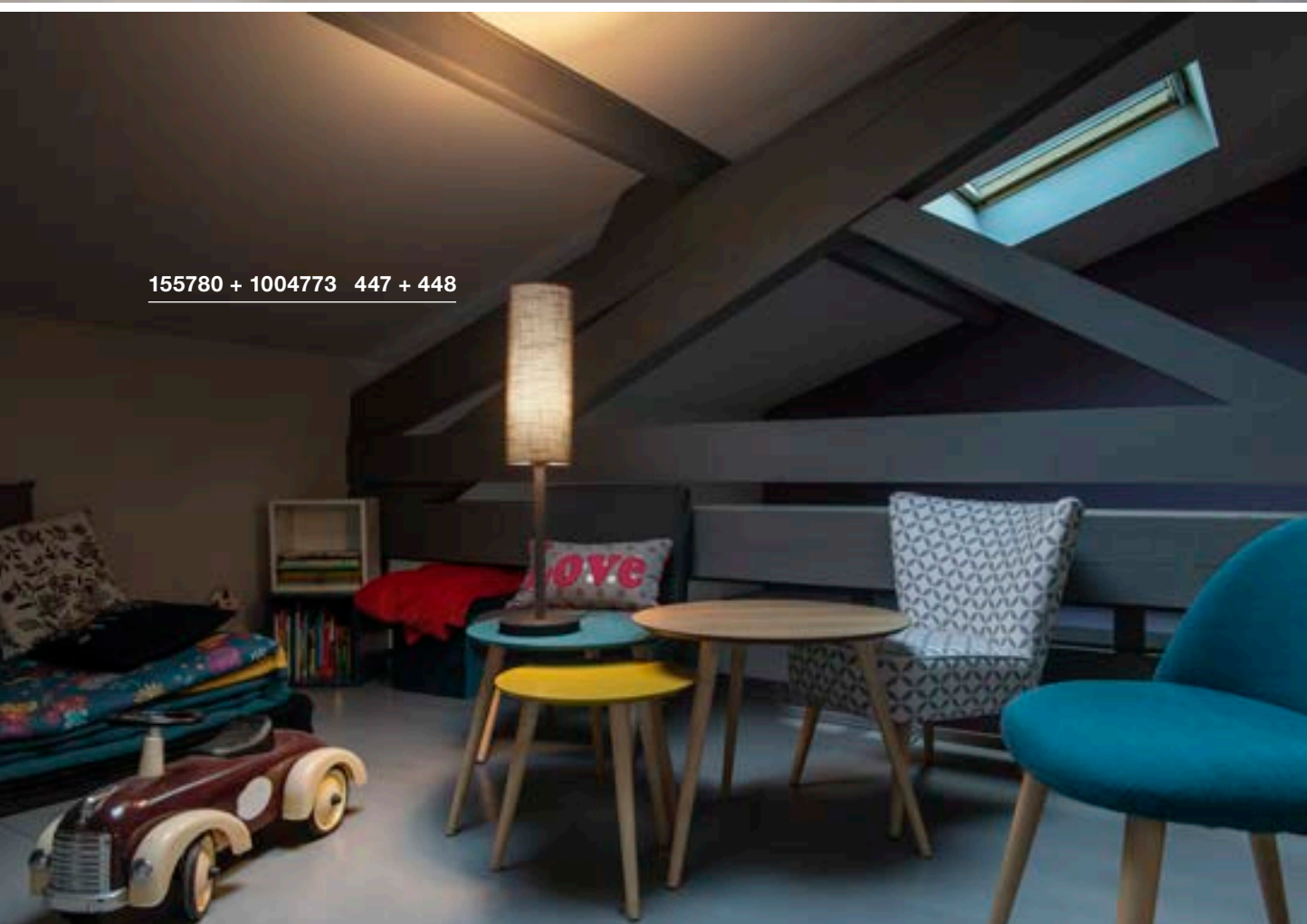

155780 + 1004773 447 + 448



FENDA TL, E27

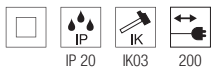
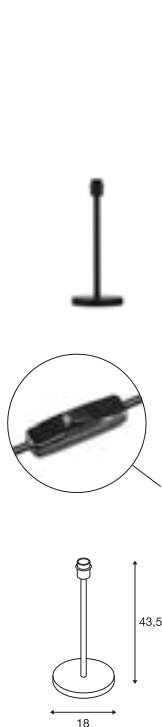

220-240V ~50/60Hz
Matière : acier

- Fiche européenne et interrupteur



Douille : 1xE27

Coloris	Ref.	CHF
● noir	155780	96.00

A60 | 7,5W | 320°
 2700K | 800lm | CEE=F
 8kWh / 1000h

Ref. : 1005303 | 12.90 CHF

FENDA FL, E27



220-240V ~50/60Hz
Matière : acier / plastique

- Fiche européenne et interrupteur



Douille : 1xE27

Coloris	Ref.	CHF
● noir	155790	169.00

LED E27 | 13,2W | 220°
 2700K | 1300lm | CEE=F
 13kWh / 1000h

Ref. : 1005302 | 17.00 CHF

FENDA TL, E27

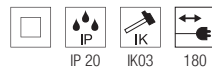
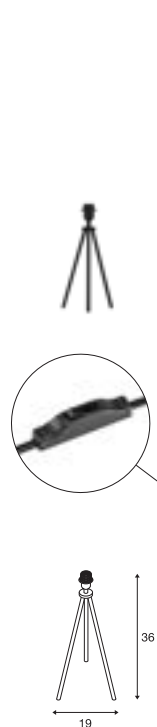

220-240V ~50/60Hz
Matière : aluminium / plastique

- Fiche européenne et interrupteur



Douille : 1xE27

Coloris	Ref.	CHF
● noir	155540	96.00

LED E27 | 7,5W | 320°
 2500K | 700lm | CEE=F
 8kWh / 1000h

Ref. : 1005265 | 33.00 CHF

FENDA
FL, E27

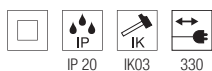
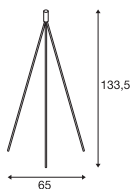

220-240V ~50/60Hz
Matière : aluminium

- Interrupteur sur la douille
- Fiche européenne



Douille : 1xE27

Coloris	Ref.	CHF
● noir	155490	156.00

LED E27 | 13,2W | 220°
2700K | 1300lm | CEE=F
13kWh / 1000h



Ref. : 1005302 | 17.00 CHF

FENDA BOW BASIS
FL, E27

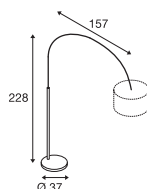

220-240V ~50/60Hz
Matière : acier

- Poids d'abat-jour max. autorisé 900 g
- Fiche européenne et interrupteur



Douille : 1xE27

L max. : 17,5 cm

Coloris	Ref.	CHF
● noir	1003029	279.00
● chrome	1000763	289.00

A60 | 7,5W | 320°
2700K | 800lm | CEE=F
8kWh / 1000h



Ref. : 1005303 | 12.90 CHF

FENDA
15 cm, rond



H : 40 cm
Ø : 15 cm
Matière : textile / acier

Coloris	Ref.	CHF
● noir / cuivre	156152	64.00
○ blanc	156141	55.00
● gris	1004773	55.00
● beige	156143	55.00



155490 + 1004773 448 + 449



FENDA
30 cm, rond



H : 20 cm
Ø : 30 cm
Matière : textile / acier

FENDA
Ø 45 cm, rond



H : 28 cm
Ø : 45,5 cm
Matière : textile / acier

FENDA
Ø 70 cm, rond



H : 36 cm
Ø : 70 cm
Matière : textile / acier

• Non compatible avec Fenda Bow.

Coloris	Ref.	CHF
● noir / cuivre	155592	85.00
○ blanc	155582	64.00
● gris	1004774	64.00
● beige	155583	64.00

Coloris	Ref.	CHF
● noir / cuivre	156122	117.00
○ blanc	156111	102.00
● gris	1004775	102.00
● beige	156113	102.00

Coloris	Ref.	CHF
● noir / cuivre	1000580	156.00
○ blanc	1000579	138.00



1003032 448

MIX & MATCH FENDA

FENDA Ø15

Noir	156152
Blanc	156141
Beige	156143
Gris	1004773



FENDA Ø30

Noir	155592
Blanc	155582
Beige	155583
Gris	1004774



FENDA Ø45

Noir	156122
Blanc	156111
Beige	156113
Gris	1004775

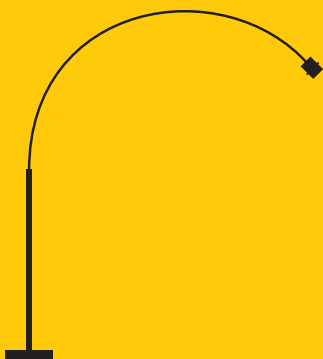

FENDA BOW

Noir	1003029
Chrome	1000763



FENDA TL

Noir	155780
------	--------



FENDA FL

Noir	155790
------	--------



FENDA TL

Noir	155540
------	--------

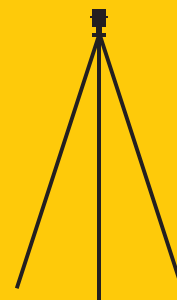

FENDA FL

Noir	155490
------	--------

Combinez les produits SLV Mix & Match selon toutes vos envies. Parfaitement assortis, vous pouvez les choisir au sein de la famille FENDA mais aussi mélanger les familles FENDA et FITU. Vous pouvez identifier les produits SLV Mix & Match à l'aide du symbole suivant :



MIX
match

FENDA Ø70

Noir | 1000580
Blanc | 1000579

FENDA Ø12,5

Glass Shade

Marron | 1000773

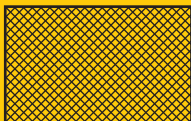

FENDA PD

Noir | 132660
Blanc | 132661
Chrome | 132662

FENDA CL

Noir | 155550
Blanc | 155551

FITU CRANE BASE

Noir | 1004682



FITU PD

Noir | 132690
Blanc | 132691

KARPO
TL



200-240V ~50/60Hz | 500mA
Puissance totale : 6,2W
Matière : aluminium

- Interrupteur sur la tête de lampe
- Bloc d'alimentation avec fiche



Down 360lm | 430lm | 3000K

Coloris	Ref.	CHF
● noir 360 lm	1001461	219.00
○ blanc 430 lm	1001460	219.00

KARPO
FL

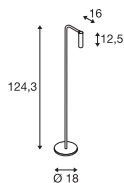

200-240V ~50/60Hz | 500mA
Puissance totale : 6,2W
Matière : aluminium

- Interrupteur sur la tête de lampe
- Bloc d'alimentation avec fiche



Down 360lm | 430lm | 3000K

Coloris	Ref.	CHF
● noir 360 lm	1001463	289.00
○ blanc 430 lm	1001462	289.00

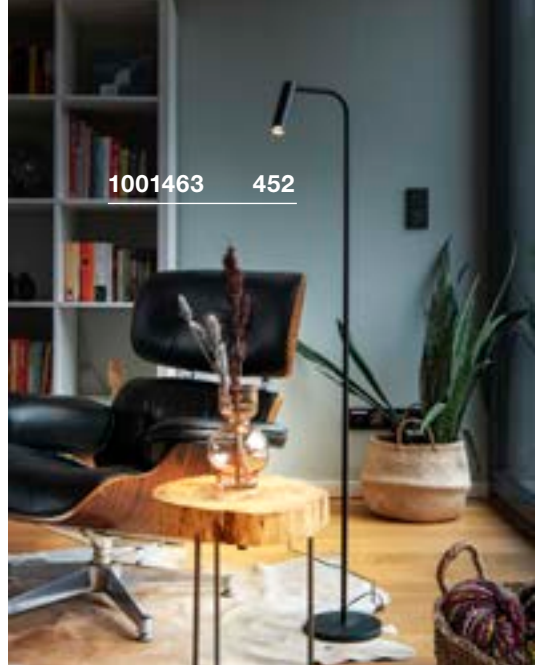

1001463 452

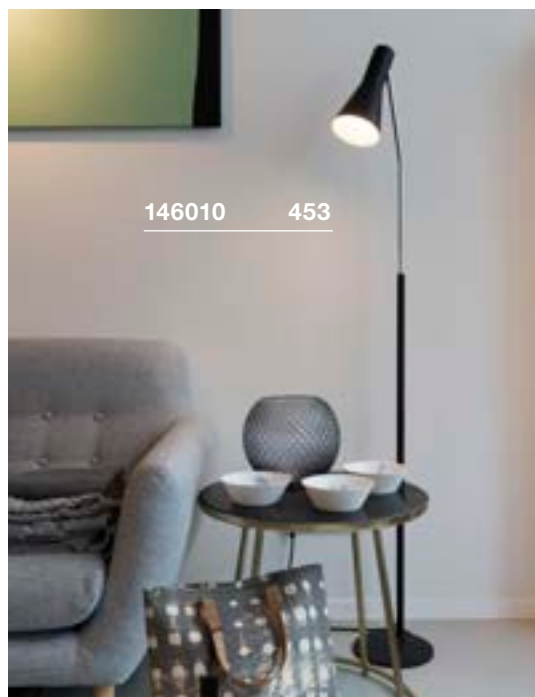

146010 453

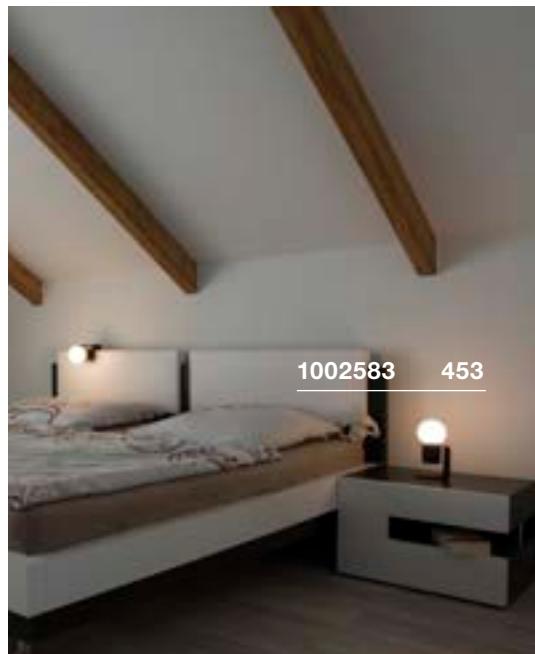

1002583 453



PHELIA
FL, E27

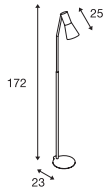

220-240V ~50/60Hz
Matière : aluminium / acier

- Interrupteur sur la douille
- Fiche et interrupteur inclus



Douille : 1xE27 Ø max. : 5,3 cm L : 18 cm

Coloris	Ref.	CHF
● noir	146010	289.00



A60 | 7,5W | 320°
2700K | 800lm | CEE=F
8kWh / 1000h



Ref. : 1005303 | 12.90 CHF

TONILA
TL

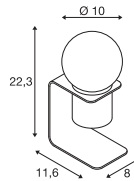

Fonctionne sur batterie 5V
Puissance totale : 1,6W
Matière : aluminium / plastique

- Batterie 3,6V 2000mAh fournie
- Alimentation non fournie. Nécessite un chargeur USB 5V DC/1-2A. Pour câble de chargement Mini USB.
- Variation d'intensité via un bouton à 3 positions.



Down 90lm | 2700K

Coloris	Ref.	CHF
● noir	1002583	149.00

MAGANDA
TL

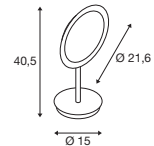

100-240V ~50/60Hz | 12V
Puissance totale : 4,8W
Matière : acier / verre

- Bouton de réglage de la température de couleur sur 3 niveaux
- Fiche IP44



45lm | 2700K 48lm | 3000K 51lm | 4000K

Coloris	Ref.	CHF
● chrome / dépoli	1004970	205.00

1006672 469

1006623 475

1006834 471





NEW



NUMINOS® XS | 468



NEW



NUMINOS® S | 468



NEW



NUMINOS® XS | 470



NEW



NUMINOS® S | 470



NEW



IN-LINE 22 | 473



NEW



IN-LINE 22 | 473



NEW



IN-LINE 44 | 475



NEW



IN-LINE 44 | 475



NEW



IN-LINE 24 | 477



NEW



IN-LINE 46 | 477

1006623 + 1006617 475 + 473





48V TRACK

Rail en saillie DALI

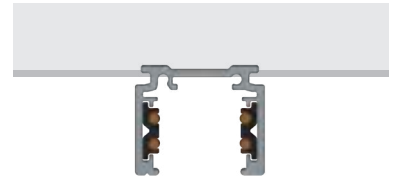

	1 m	1 m	2 m	2 m
Tension nominale (V)	48V DC	48V DC	48V DC	48V DC
Intensité max. (A)	16	16	16	16
Charge mécanique max.	5 kg	5 kg	10 kg	10 kg
Coloris	● noir	○ blanc	● noir	○ blanc
Matière	Aluminium	Aluminium	Aluminium	Aluminium
L x l x H (cm)	100 x 2,62 x 2,26	100 x 2,62 x 2,26	200 x 2,62 x 2,26	200 x 2,62 x 2,26
Ref.	1006541 ●	1006542 ●	1006543 ●	1006544 ●
CHF	60.90	60.90	105.00	105.00

	3 m	3 m	4 m	4 m
Tension nominale (V)	48V DC	48V DC	48V DC	48V DC
Intensité max. (A)	16	16	16	16
Charge mécanique max.	15 kg	15 kg	20 kg	20 kg
Coloris	● noir	○ blanc	● noir	○ blanc
Matière	Aluminium	Aluminium	Aluminium	Aluminium
L x l x H (cm)	300 x 2,62 x 2,26	300 x 2,62 x 2,26	400 x 2,62 x 2,26	400 x 2,62 x 2,26
Ref.	1006545 ●	1006546 ●	1006547 ●	1006548 ●
CHF	165.00	165.00	225.00	225.00



48V TRACK

Rail en saillie DALI



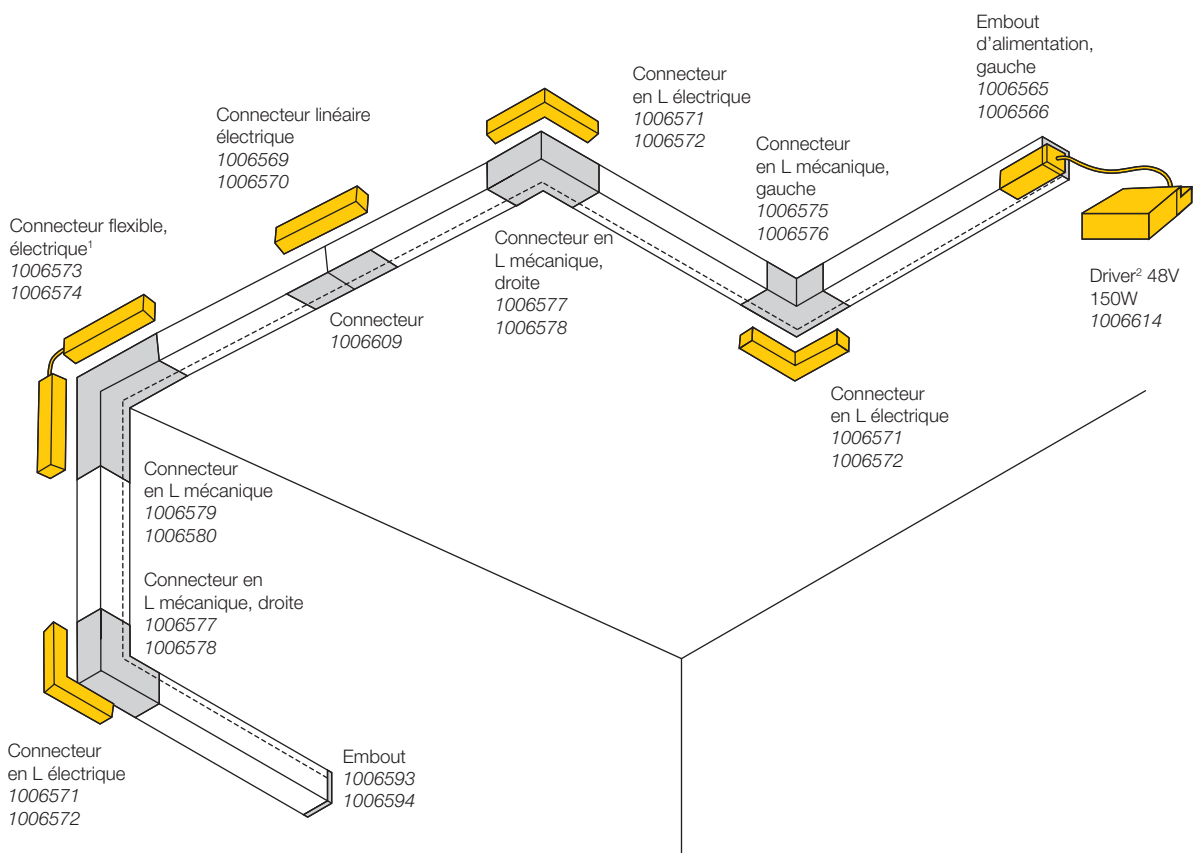











Outil de configuration et accessoires en un seul coup d'œil



¹ Veuillez noter que les connecteurs électriques et mécaniques ne doivent jamais être mélangés dans une installation.

² Le driver doit être placé en externe.



 <p>Embout d'alimentation, droite 16A max. polycarbonate (PC) L : 9,7 cm l : 1,6 cm H : 1,9 cm</p> <p>● noir Ref. 1006567 17.90 CHF ○ blanc Ref. 1006568 17.90 CHF</p>	 <p>Driver 48V 60W Polycarbonate (PC) L : 18 cm l : 4,5 cm H : 2,7 cm</p> <p>○ blanc Ref. 1006613 74.90 CHF</p>
 <p>Embout d'alimentation, gauche 16A max. polycarbonate (PC) L : 9,7 cm l : 1,6 cm H : 1,9 cm</p> <p>● noir Ref. 1006565 17.90 CHF ○ blanc Ref. 1006566 17.90 CHF</p>	 <p>Driver 150W 48V Métal / polycarbonate (PC) L : 19,05 cm l : 8,8 cm H : 3,55 cm</p> <p>● noir Ref. 1006614 160.00 CHF</p>
 <p>Connecteur en L mécanique, pour rail en saillie standard, droite (montage au plafond) Aluminium L : 7,1 cm l : 7,1 cm H : 2,19 cm</p> <p>● noir Ref. 1006577 25.90 CHF ○ blanc Ref. 1006578 25.90 CHF</p>	 <p>Cache, 20 mm pour montage standard sur rail, 2 m Aluminium / polycarbonate (PC) L : 200 cm l : 2 cm H : 0,6 cm</p> <p>● noir Ref. 1006611 12.90 CHF ○ blanc Ref. 1006612 12.90 CHF</p>
 <p>Connecteur en L mécanique, pour rail en saillie standard, gauche (montage au plafond) Aluminium L : 7,1 cm l : 7,1 cm H : 2,19 cm</p> <p>● noir Ref. 1006575 25.90 CHF ○ blanc Ref. 1006576 25.90 CHF</p>	 <p>Embout pour rail en saillie standard Polycarbonate (PC) L : 2,6 cm l : 0,2 cm H : 2,2 cm</p> <p>● noir Ref. 1006593 4.50 CHF ○ blanc Ref. 1006594 4.50 CHF</p>
 <p>Connecteur en L mécanique, pour rail en saillie, standard, mur/plafond Aluminium L : 8,4 cm l : 2,62 cm H : 8,4 cm</p> <p>● noir Ref. 1006579 25.90 CHF ○ blanc Ref. 1006580 25.90 CHF</p>	 <p>Plaque de renforcement pour rail en saillie Acier L : 5 cm l : 1,32 cm H : 0,25 cm</p> <p>● gris Ref. 1006609 11.90 CHF</p>
 <p>Connecteur en L électrique, DALI 16A max. polycarbonate (PC) L : 11,4 cm l : 11,4 cm H : 1,9 cm</p> <p>● noir Ref. 1006571 32.90 CHF ○ blanc Ref. 1006572 32.90 CHF</p>	 <p>Plaque de renforcement pour rail avec kit de suspension, filin de 3 m Acier L : 12 cm l : 2,7 cm</p> <p>● noir Ref. 1006603 25.90 CHF ○ blanc Ref. 1006604 25.90 CHF</p>
 <p>Connecteur longitudinal électrique, DALI 16A max. polycarbonate (PC) L : 14,4 cm l : 1,6 cm H : 1,9 cm</p> <p>● noir Ref. 1006569 25.90 CHF ○ blanc Ref. 1006570 25.90 CHF</p>	 <p>Plaque de renforcement pour rail avec kit de suspension, tige d'1 m Acier L : 12 cm l : 2,7 cm</p> <p>● noir Ref. 1006601 25.90 CHF ○ blanc Ref. 1006602 25.90 CHF</p>
 <p>Connecteur flexible, électrique, DALI 16A max. polycarbonate (PC) L : 23 cm l : 1,6 cm H : 1,9 cm</p> <p>● noir Ref. 1006573 36.50 CHF ○ blanc Ref. 1006574 36.50 CHF</p>	 <p>Suspension rigide, tige d'1 m Acier l : 2,9 cm</p> <p>● noir Ref. 1006605 22.90 CHF ○ blanc Ref. 1006606 22.90 CHF</p>
 <p>Boîtier pour driver avec embout d'alimentation à droite, DALI Polycarbonate (PC) L : 23,3 cm l : 10,1 cm H : 4,1 cm</p> <p>● noir Ref. 1007137 43.50 CHF ○ blanc Ref. 1007138 43.50 CHF</p>	 <p>Kit de suspension, filin de 3 m Acier l : 2,9 cm</p> <p>● noir Ref. 1006607 22.90 CHF ○ blanc Ref. 1006608 22.90 CHF</p>
 <p>Boîtier pour driver avec embout d'alimentation à gauche, DALI Polycarbonate (PC) L : 23,3 cm l : 10,1 cm H : 4,1 cm</p> <p>● noir Ref. 1007083 43.50 CHF ○ blanc Ref. 1007084 43.50 CHF</p>	 <p>Clip de fixation Aluminium L : 3 cm l : 2,72 cm H : 1,05 cm</p> <p>● noir Ref. 1006599 9.90 CHF ○ blanc Ref. 1006600 9.90 CHF</p>

1006726 + 1006623 + 1006617 469 + 475 + 473

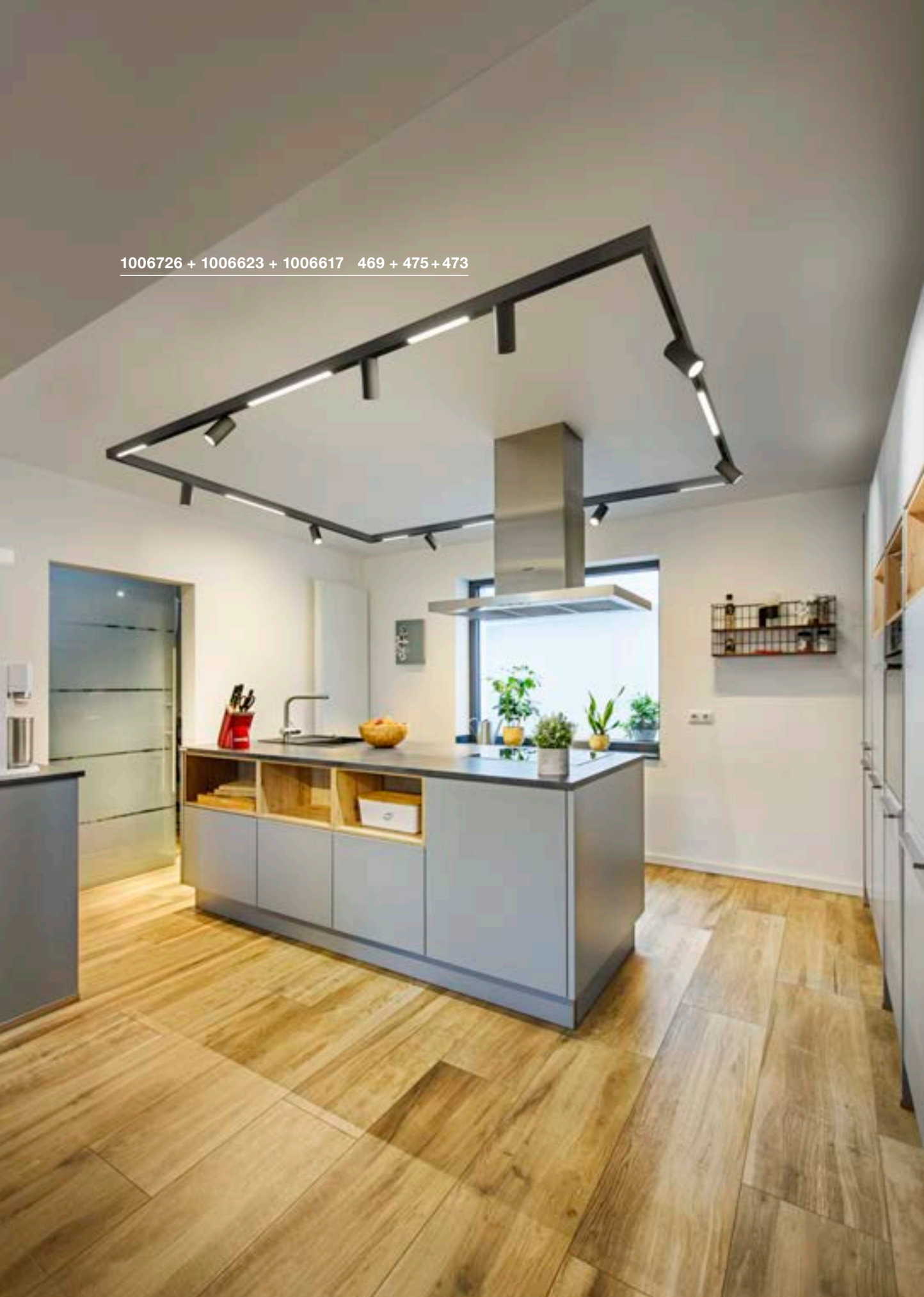



48V TRACK

Rail en saillie profond DALI



	1 m	1 m	2 m	2 m
Tension nominale (V)	48V DC	48V DC	48V DC	48V DC
Intensité max. (A)	16	16	16	16
Charge mécanique max.	5 kg	5 kg	10 kg	10 kg
Coloris	● noir	○ blanc	● noir	○ blanc
Matière	Aluminium	Aluminium	Aluminium	Aluminium
L x l x H (cm)	100 x 2,62 x 4,72	100 x 2,62 x 4,72	200 x 2,62 x 4,72	200 x 2,62 x 4,72
Ref.	1006549 ●	1006550 ●	1006551 ●	1006552 ●
CHF	74.90	74.90	140.00	140.00
	3 m	3 m	4 m	4 m
Tension nominale (V)	48V DC	48V DC	48V DC	48V DC
Intensité max. (A)	16	16	16	16
Charge mécanique max.	15 kg	15 kg	20 kg	20 kg
Coloris	● noir	○ blanc	● noir	○ blanc
Matière	Aluminium	Aluminium	Aluminium	Aluminium
L x l x H (cm)	300 x 2,62 x 4,72	300 x 2,62 x 4,72	400 x 2,62 x 4,72	400 x 2,62 x 4,72
Ref.	1006553 ●	1006554 ●	1006555 ●	1006556 ●
CHF	210.00	210.00	280.00	280.00



NEW

48V TRACK

Rail en saillie profond DALI

Outil de configuration et accessoires en un seul coup d'œil

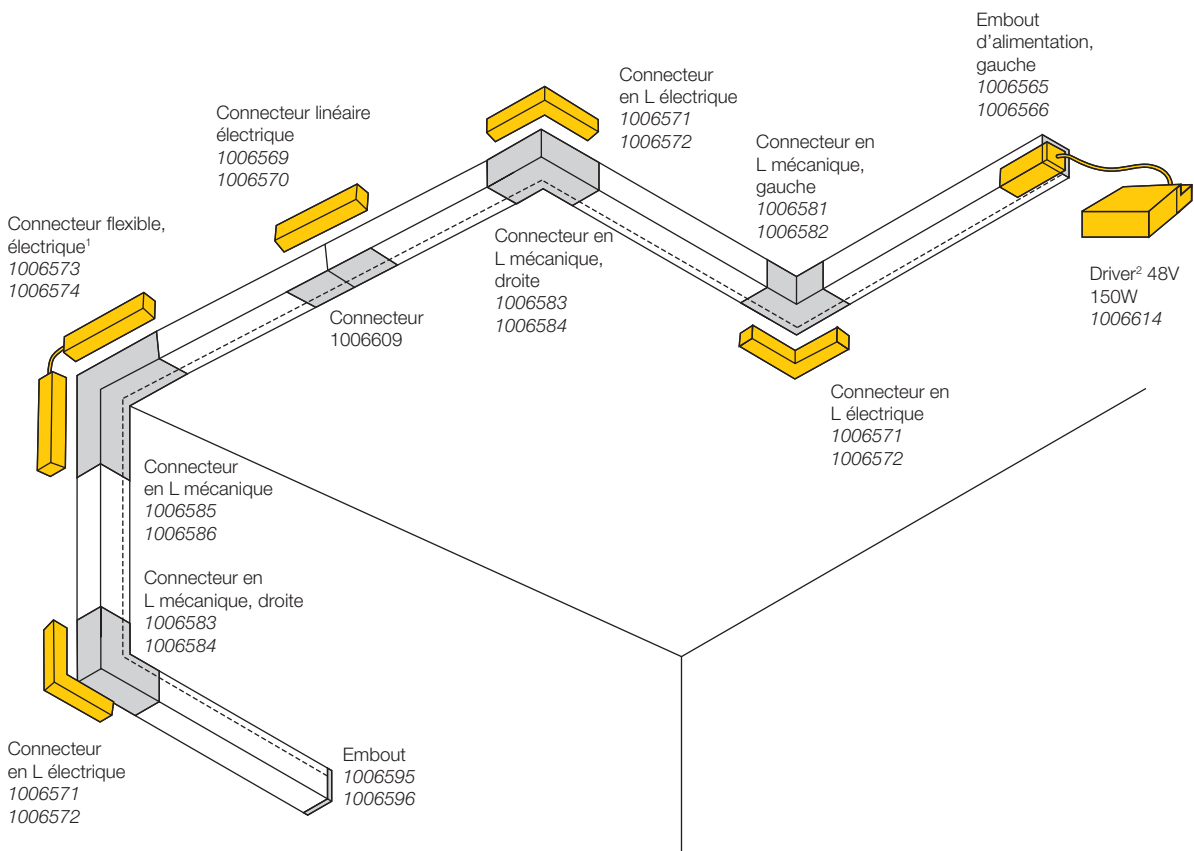

¹ Veuillez noter que les connecteurs électriques et mécaniques ne doivent jamais être mélangés dans une installation.

² Le driver doit être placé en externe.



<p>Embout d'alimentation, droite 16A max. polycarbonate (PC) L : 9,7 cm l : 1,6 cm H : 1,9 cm</p> <p>● noir Ref. 1006567 17.90 CHF ○ blanc Ref. 1006568 17.90 CHF</p>	<p>Driver 48V 60W Polycarbonate (PC) L : 18 cm l : 4,5 cm H : 2,7 cm</p> <p>○ blanc Ref. 1006613 74.90 CHF</p>
<p>Embout d'alimentation, gauche 16A max. polycarbonate (PC) L : 9,7 cm l : 1,6 cm H : 1,9 cm</p> <p>● noir Ref. 1006565 17.90 CHF ○ blanc Ref. 1006566 17.90 CHF</p>	<p>Driver 150W 48V Métal / polycarbonate (PC) L : 19,05 cm l : 8,8 cm H : 3,55 cm</p> <p>● noir Ref. 1006614 160.00 CHF</p>
<p>Connecteur en L mécanique pour rail en saillie profond, droite (montage au plafond) Aluminium L : 7,1 cm l : 7,1 cm H : 4,7 cm</p> <p>● noir Ref. 1006583 36.50 CHF ○ blanc Ref. 1006584 36.50 CHF</p>	<p>Cache, 26 mm, pour rail encastré et en saillie profond, 2 m Polycarbonate (PC) L : 200 cm l : 26 cm H : 6 cm</p> <p>● noir Ref. 1007188 14.90 CHF ○ blanc Ref. 1007189 14.90 CHF</p>
<p>Connecteur en L mécanique pour rail en saillie profond, gauche (montage au plafond) Aluminium L : 7,1 cm l : 7,1 cm H : 4,7 cm</p> <p>● noir Ref. 1006581 36.50 CHF ○ blanc Ref. 1006582 36.50 CHF</p>	<p>Embout pour rail en saillie profond Polycarbonate (PC) L : 2,6 cm l : 0,2 cm H : 4,7 cm</p> <p>● noir Ref. 1006595 7.90 CHF ○ blanc Ref. 1006596 7.90 CHF</p>
<p>Connecteur en L mécanique, pour rail en saillie, profond, mur/plafond Aluminium L : 8,4 cm l : 8,4 cm H : 4,7 cm</p> <p>● noir Ref. 1006585 36.50 CHF ○ blanc Ref. 1006586 36.50 CHF</p>	<p>Plaque de renforcement pour rail en saillie Acier L : 5 cm l : 1,32 cm H : 0,25 cm</p> <p>● gris Ref. 1006609 11.90 CHF</p>
<p>Connecteur en L électrique, DALI 16A max. polycarbonate (PC) L : 11,4 cm l : 11,4 cm H : 1,9 cm</p> <p>● noir Ref. 1006571 32.90 CHF ○ blanc Ref. 1006572 32.90 CHF</p>	<p>Plaque de renforcement pour rail avec kit de suspension, filin de 3 m Acier L : 12 cm l : 2,7 cm</p> <p>● noir Ref. 1006603 25.90 CHF ○ blanc Ref. 1006604 25.90 CHF</p>
<p>Connecteur longitudinal électrique, DALI 16A max. polycarbonate (PC) L : 14,4 cm l : 1,6 cm H : 1,9 cm</p> <p>● noir Ref. 1006569 25.90 CHF ○ blanc Ref. 1006570 25.90 CHF</p>	<p>Plaque de renforcement pour rail avec kit de suspension, tige d'1 m Acier L : 12 cm l : 2,7 cm</p> <p>● noir Ref. 1006601 25.90 CHF ○ blanc Ref. 1006602 25.90 CHF</p>
<p>Connecteur flexible, électrique, DALI 16A max. polycarbonate (PC) L : 23 cm l : 1,6 cm H : 1,9 cm</p> <p>● noir Ref. 1006573 36.50 CHF ○ blanc Ref. 1006574 36.50 CHF</p>	<p>Suspension rigide, tige d'1 m Acier l : 2,9 cm</p> <p>● noir Ref. 1006605 22.90 CHF ○ blanc Ref. 1006606 22.90 CHF</p>
<p>Boîtier pour driver avec embout d'alimentation à droite, DALI Polycarbonate (PC) L : 23,3 cm l : 10,1 cm H : 4,1 cm</p> <p>● noir Ref. 1007137 43.50 CHF ○ blanc Ref. 1007138 43.50 CHF</p>	<p>Kit de suspension, filin de 3 m Acier l : 2,9 cm</p> <p>● noir Ref. 1006607 22.90 CHF ○ blanc Ref. 1006608 22.90 CHF</p>
<p>Boîtier pour driver avec embout d'alimentation à gauche, DALI Polycarbonate (PC) L : 23,3 cm l : 10,1 cm H : 4,1 cm</p> <p>● noir Ref. 1007083 43.50 CHF ○ blanc Ref. 1007084 43.50 CHF</p>	<p>Clip de fixation Aluminium L : 3 cm l : 2,72 cm H : 1,05 cm</p> <p>● noir Ref. 1006599 9.90 CHF ○ blanc Ref. 1006600 9.90 CHF</p>

1006783 + 1006672 + 1006635 471 + 471 + 475

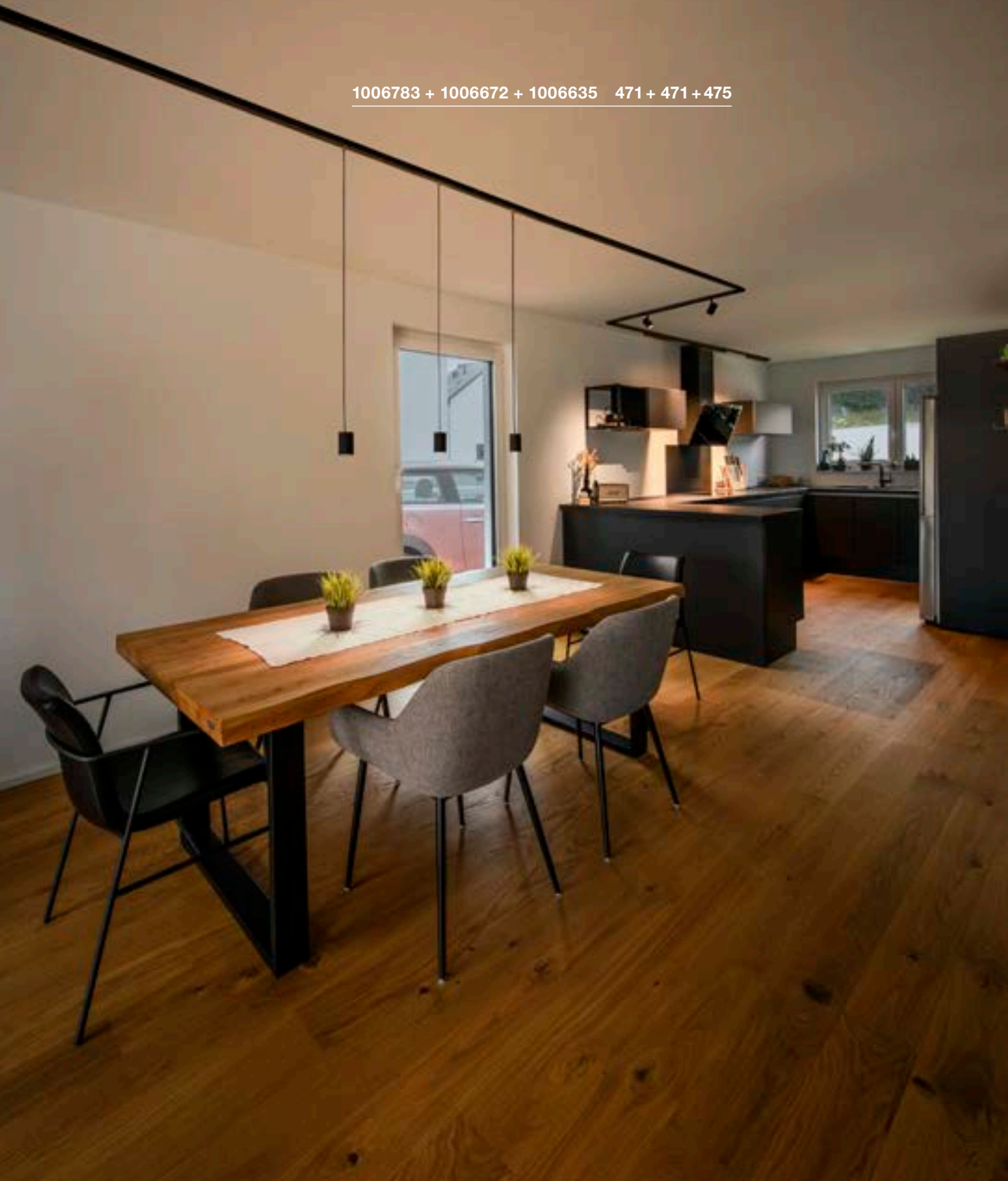



NEW

48V TRACK

Rail encastré DALI

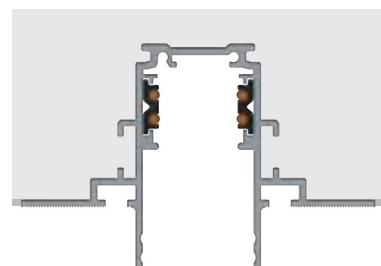

	1 m	1 m	2 m	2 m
Tension nominale (V)	48V DC	48V DC	48V DC	48V DC
Intensité max. (A)	16	16	16	16
Charge mécanique max.	5 kg	5 kg	10 kg	10 kg
Coloris	● noir	○ blanc	● noir	○ blanc
Matière	Aluminium	Aluminium	Aluminium	Aluminium
L x l x H (cm)	100 x 7,4 x 4,7	100 x 7,4 x 4,7	200 x 7,4 x 4,7	200 x 7,4 x 4,7
Ref.	1006557 ●	1006558 ●	1006559 ●	1006560 ●
CHF	99.90	99.90	170.00	170.00
	3 m	3 m	4 m	4 m
Tension nominale (V)	48V DC	48V DC	48V DC	48V DC
Intensité max. (A)	16	16	16	16
Charge mécanique max.	15 kg	15 kg	20 kg	20 kg
Coloris	● noir	○ blanc	● noir	○ blanc
Matière	Aluminium	Aluminium	Aluminium	Aluminium
L x l x H (cm)	300 x 7,4 x 4,7	300 x 7,4 x 4,7	400 x 7,4 x 4,7	400 x 7,4 x 4,7
Ref.	1006561 ●	1006562 ●	1006563 ●	1006564 ●
CHF	220.00	220.00	320.00	320.00



48V TRACK

Rail encastré DALI

Outil de configuration et accessoires en un seul coup d'œil

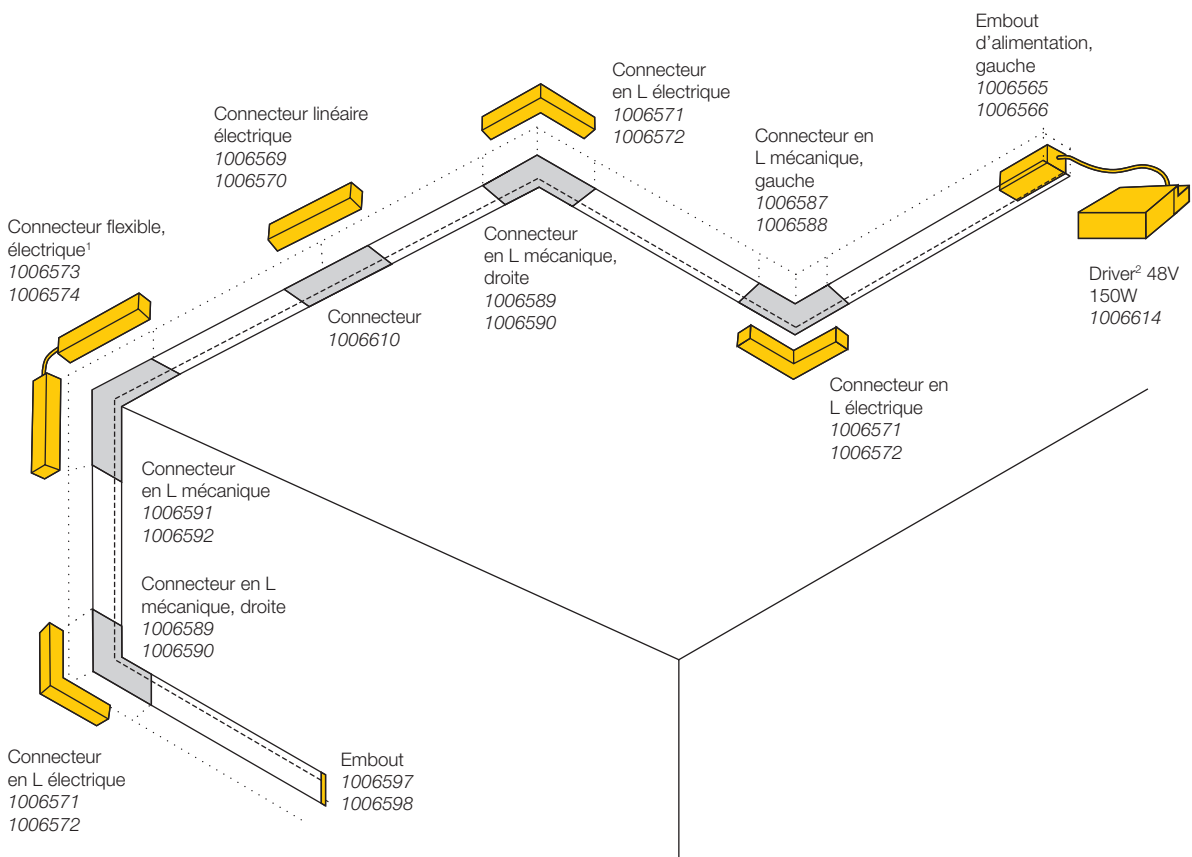

¹ Veuillez noter que les connecteurs électriques et mécaniques ne doivent jamais être mélangés dans une installation.

² Le driver doit être placé en externe.



Embout d'alimentation, droite
16A max. | polycarbonate (PC)
L : 9,7 cm | l : 1,6 cm | H : 1,9 cm

● noir Ref. 1006567 17.90 CHF
○ blanc Ref. 1006568 17.90 CHF

Driver 48V | 60W
Polycarbonate (PC)
L : 18 cm | l : 4,5 cm | H : 2,7 cm

○ blanc Ref. 1006613 74.90 CHF

Embout d'alimentation, gauche
16A max. | polycarbonate (PC)
L : 9,7 cm | l : 1,6 cm | H : 1,9 cm

● noir Ref. 1006565 17.90 CHF
○ blanc Ref. 1006566 17.90 CHF

Driver 150W | 48V
Métal / polycarbonate (PC)
L : 19,05 cm | l : 8,8 cm | H : 3,55 cm

● noir Ref. 1006614 160.00 CHF

Connecteur en L mécanique pour rail encastré profond, droite (montage au plafond)
Aluminium
L : 9,5 cm | l : 9,5 cm | H : 4,7 cm

● noir Ref. 1006589 39.90 CHF
○ blanc Ref. 1006590 39.90 CHF

Cache pour rail, 26 mm, 2 m
Polycarbonate (PC)
L : 200 cm | l : 26 cm | H : 6 cm

● noir Ref. 1007188 14.90 CHF
○ blanc Ref. 1007189 14.90 CHF

Connecteur en L mécanique pour rail encastré profond, gauche (montage au plafond)
Aluminium
L : 9,5 cm | l : 9,5 cm | H : 4,7 cm

● noir Ref. 1006587 39.90 CHF
○ blanc Ref. 1006588 39.90 CHF

Embout pour rail encastré
Polycarbonate (PC)
L : 3,4 cm | l : 0,2 cm | H : 4,7 cm

● noir Ref. 1006597 4.50 CHF
○ blanc Ref. 1006598 4.50 CHF

Connecteur en L mécanique, pour rail encastré, profond, mur/plafond
Aluminium
L : 8,1 cm | l : 7,4 cm | H : 8,1 cm

● noir Ref. 1006591 39.90 CHF
○ blanc Ref. 1006592 39.90 CHF

Kit de renforcement pour rail encastré
Acier
L : 6,3 cm | l : 0,76 cm | H : 0,25 cm

● gris Ref. 1006610 11.90 CHF

Connecteur en L électrique, DALI
16A max. | polycarbonate (PC)
L : 11,4 cm | l : 11,4 cm | H : 1,9 cm

● noir Ref. 1006571 32.90 CHF
○ blanc Ref. 1006572 32.90 CHF

Plaque de renforcement pour rail avec kit de suspension, filin de 3 m
Acier
L : 12 cm | l : 2,7 cm

● noir Ref. 1006603 25.90 CHF
○ blanc Ref. 1006604 25.90 CHF

Connecteur longitudinal électrique, DALI
16A max. | polycarbonate (PC)
L : 14,4 cm | l : 1,6 cm | H : 1,9 cm

● noir Ref. 1006569 25.90 CHF
○ blanc Ref. 1006570 25.90 CHF

Plaque de renforcement pour rail avec kit de suspension, tige d'1 m
Acier
L : 12 cm | l : 2,7 cm

● noir Ref. 1006601 25.90 CHF
○ blanc Ref. 1006602 25.90 CHF

Connecteur flexible, électrique, DALI
16A max. | polycarbonate (PC)
L : 23 cm | l : 1,6 cm | H : 1,9 cm

● noir Ref. 1006573 36.50 CHF
○ blanc Ref. 1006574 36.50 CHF

Suspension rigide, tige d'1 m
Acier
l : 2,9 cm

● noir Ref. 1006605 22.90 CHF
○ blanc Ref. 1006606 22.90 CHF

Boîtier pour driver avec embout d'alimentation à droite, DALI
Polycarbonate (PC)
L : 23,3 cm | l : 10,1 cm | H : 4,1 cm

● noir Ref. 1007137 43.50 CHF
○ blanc Ref. 1007138 43.50 CHF

Kit de suspension, filin de 3 m
Acier
l : 2,9 cm

● noir Ref. 1006607 22.90 CHF
○ blanc Ref. 1006608 22.90 CHF

Boîtier pour driver avec embout d'alimentation à gauche, DALI
Polycarbonate (PC)
L : 23,3 cm | l : 10,1 cm | H : 4,1 cm

● noir Ref. 1007083 43.50 CHF
○ blanc Ref. 1007084 43.50 CHF

Clip de fixation
Aluminium
L : 3 cm | l : 2,72 cm | H : 1,05 cm

● noir Ref. 1006599 9.90 CHF
○ blanc Ref. 1006600 9.90 CHF

1006635 + 1006729 475 + 469

NUMINOS® XS
48V, DALI

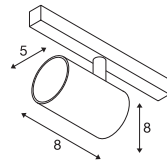
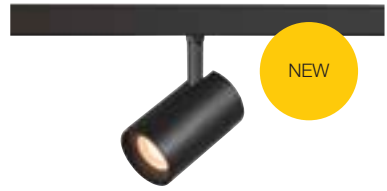

NUMINOS® S
48V, DALI

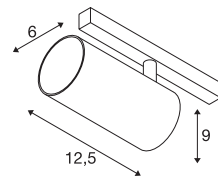



NUMINOS® SPOT 48V

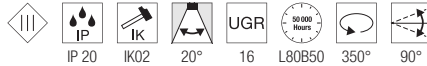

XS 48V | 200mA
 Puissance totale : 8,7W
 Matière : aluminium / polycarbonate (PC)

S 48V | 350mA
 Puissance totale : 16W
 Matière : aluminium / polycarbonate (PC)

		2700K	20°	640lm	1006651	240.00 CHF	100lm	1006705	255.00 CHF
			40°	620lm	1006654	240.00 CHF	970lm	1006708	255.00 CHF
			55°	640lm	1006657	240.00 CHF	960lm	1006711	255.00 CHF
		3000K	20°	700lm	1006669	240.00 CHF	1060lm	1006723	255.00 CHF
			40°	670lm	1006672	240.00 CHF	1030lm	1006726	255.00 CHF
			55°	690lm	1006675	240.00 CHF	1030lm	1006729	255.00 CHF
		2700K	20°	670lm	1006652	240.00 CHF	1020lm	1006706	255.00 CHF
			40°	650lm	1006655	240.00 CHF	1050lm	1006709	255.00 CHF
			55°	670lm	1006658	240.00 CHF	1030lm	1006712	255.00 CHF
		3000K	20°	730lm	1006670	240.00 CHF	1120lm	1006724	255.00 CHF
			40°	700lm	1006673	240.00 CHF	1120lm	1006727	255.00 CHF
			55°	720lm	1006676	240.00 CHF	1120lm	1006730	255.00 CHF
		2700K	20°	670lm	1006653	240.00 CHF	960lm	1006707	255.00 CHF
			40°	650lm	1006656	240.00 CHF	1000lm	1006710	255.00 CHF
			55°	670lm	1006659	240.00 CHF	980lm	1006713	255.00 CHF
		3000K	20°	730lm	1006671	240.00 CHF	1050lm	1006725	255.00 CHF
			40°	700lm	1006674	240.00 CHF	1050lm	1006728	255.00 CHF
			55°	720lm	1006677	240.00 CHF	1050lm	1006731	255.00 CHF
		2700K	20°	670lm	1006661	240.00 CHF	1020lm	1006715	255.00 CHF
			40°	650lm	1006664	240.00 CHF	1050lm	1006718	255.00 CHF
			55°	670lm	1006667	240.00 CHF	1030lm	1006721	255.00 CHF
		3000K	20°	730lm	1006679	240.00 CHF	1120lm	1006733	255.00 CHF
			40°	700lm	1006682	240.00 CHF	1120lm	1006736	255.00 CHF
			55°	720lm	1006685	240.00 CHF	1120lm	1006739	255.00 CHF
		2700K	20°	640lm	1006660	240.00 CHF	1000lm	1006714	255.00 CHF
			40°	620lm	1006663	240.00 CHF	970lm	1006717	255.00 CHF
			55°	640lm	1006666	240.00 CHF	960lm	1006720	255.00 CHF
		3000K	20°	700lm	1006678	240.00 CHF	1060lm	1006732	255.00 CHF
			40°	670lm	1006681	240.00 CHF	1030lm	1006735	255.00 CHF
			55°	690lm	1006684	240.00 CHF	1030lm	1006738	255.00 CHF
		2700K	20°	670lm	1006662	240.00 CHF	960lm	1006716	255.00 CHF
			40°	650lm	1006665	240.00 CHF	1000lm	1006719	255.00 CHF
			55°	670lm	1006668	240.00 CHF	980lm	1006722	255.00 CHF
		3000K	20°	730lm	1006680	240.00 CHF	1050lm	1006734	255.00 CHF
			40°	700lm	1006683	240.00 CHF	1050lm	1006737	255.00 CHF
			55°	720lm	1006686	240.00 CHF	1050lm	1006740	255.00 CHF

⊕

Article	Ref.	CHF
Diffuseur elliptique XS		
● transparent	1005612	5.25
Diffuseur prismatique XS		
● transparent	1005613	6.30
Diffuseur dépoli XS		
○ dépoli	1005614	6.30
Diffuseur nid d'abeille XS		
● noir	1005615	10.60

⊕

Article	Ref.	CHF
Diffuseur elliptique S		
● transparent	1004786	5.25
Diffuseur prismatique S		
● transparent	1004787	6.30
Diffuseur dépoli S		
○ dépoli	1004788	6.30
Diffuseur nid d'abeille S		
● noir	1004789	10.60

Le modèle 4000K est également disponible sur demande (sauf XS). Veuillez tenir compte des délais de livraison différents et des quantités minimales de commande.

1006844 471

NUMINOS® XS
48V, DALI

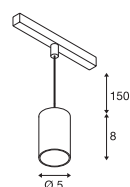

NUMINOS® S
48V, DALI

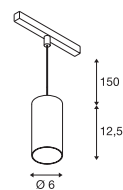



NUMINOS® SUSPENSION 48V



XS 48V | 200mA
Puissance totale : 8,7W
Matière : aluminium / polycarbonate (PC)

S 48V | 350mA
Puissance totale : 16W
Matière : aluminium / polycarbonate (PC)

		2700K	20°	460lm	1006759	255.00 CHF	1000lm	1006813	265.00 CHF
			40°	620lm	1006762	255.00 CHF	970lm	1006816	265.00 CHF
			55°	640lm	1006765	255.00 CHF	960lm	1006819	265.00 CHF
		3000K	20°	700lm	1006777	255.00 CHF	1060lm	1006831	265.00 CHF
			40°	670lm	1006780	255.00 CHF	1030lm	1006834	265.00 CHF
			55°	690lm	1006783	255.00 CHF	1030lm	1006837	265.00 CHF
		2700K	20°	670lm	1006760	255.00 CHF	1020lm	1006814	265.00 CHF
			40°	650lm	1006763	255.00 CHF	1050lm	1006817	265.00 CHF
			55°	670lm	1006766	255.00 CHF	1030lm	1006820	265.00 CHF
		3000K	20°	730lm	1006778	255.00 CHF	1120lm	1006832	265.00 CHF
			40°	700lm	1006781	255.00 CHF	1120lm	1006835	265.00 CHF
			55°	720lm	1006784	255.00 CHF	1120lm	1006838	265.00 CHF
		2700K	20°	670lm	1006761	255.00 CHF	960lm	1006815	265.00 CHF
			40°	650lm	1006764	255.00 CHF	1000lm	1006818	265.00 CHF
			55°	670lm	1006767	255.00 CHF	980lm	1006821	265.00 CHF
		3000K	20°	730lm	1006779	255.00 CHF	1050lm	1006833	265.00 CHF
			40°	700lm	1006782	255.00 CHF	1050lm	1006836	265.00 CHF
			55°	720lm	1006785	255.00 CHF	1050lm	1006839	265.00 CHF
		2700K	20°	670lm	1006769	255.00 CHF	1020lm	1006823	265.00 CHF
			40°	650lm	1006772	255.00 CHF	1050lm	1006826	265.00 CHF
			55°	670lm	1006775	255.00 CHF	1030lm	1006829	265.00 CHF
		3000K	20°	730lm	1006787	255.00 CHF	1120lm	1006841	265.00 CHF
			40°	700lm	1006790	255.00 CHF	1120lm	1006844	265.00 CHF
			55°	720lm	1006793	255.00 CHF	1120lm	1006847	265.00 CHF
		2700K	20°	620lm	1006771	255.00 CHF	1000lm	1006822	265.00 CHF
			40°	640lm	1006768	255.00 CHF	970lm	1006825	265.00 CHF
			55°	640lm	1006774	255.00 CHF	960lm	1006828	265.00 CHF
		3000K	20°	700lm	1006786	255.00 CHF	1060lm	1006840	265.00 CHF
			40°	670lm	1006789	255.00 CHF	1030lm	1006843	265.00 CHF
			55°	690lm	1006792	255.00 CHF	1030lm	1006846	265.00 CHF
		2700K	20°	670lm	1006770	255.00 CHF	960lm	1006824	265.00 CHF
			40°	650lm	1006773	255.00 CHF	1000lm	1006827	265.00 CHF
			55°	670lm	1006776	255.00 CHF	980lm	1006830	265.00 CHF
		3000K	20°	730lm	1006788	255.00 CHF	1050lm	1006842	265.00 CHF
			40°	700lm	1006791	255.00 CHF	1050lm	1006845	265.00 CHF
			55°	720lm	1006794	255.00 CHF	1050lm	1006848	265.00 CHF



Article	Ref.	CHF
Diffuseur elliptique XS		
● transparent	1005612	5.25
Diffuseur prismatique XS		
● transparent	1005613	6.30
Diffuseur dépoli XS		
○ dépoli	1005614	6.30
Diffuseur nid d'abeille XS		
● noir	1005615	10.60



Article	Ref.	CHF
Diffuseur elliptique S		
● transparent	1004786	5.25
Diffuseur prismatique S		
● transparent	1004787	6.30
Diffuseur dépoli S		
○ dépoli	1004788	6.30
Diffuseur nid d'abeille S		
● noir	1004789	10.60

Le modèle 4000K est également disponible sur demande (sauf XS). Veuillez tenir compte des délais de livraison différents et des quantités minimales de commande.

1006654 + 1006633 + 1006627 469 + 475 + 473





IN-LINE 22
48V, opal, DALI



NEW

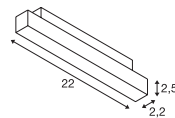

48V | 350mA
Puissance LED : 6W
Puissance totale : 7,3W
Matière : aluminium



Down 540lm | 2700K
570lm | 3000K

Coloris	Ref.	CHF
● noir 540lm 2700K	1006615	155.00
● noir 570lm 3000K	1006617	155.00
○ blanc 540lm 2700K	1006616	155.00
○ blanc 570lm 3000K	1006618	155.00

IN-LINE 22
48V, Darklight Reflector, DALI



NEW

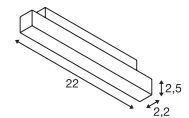

48V | 350mA
Puissance LED : 6W
Puissance totale : 7,3W
Matière : aluminium / polycarbonate (PC)



Down 580lm | 2700K
610lm | 3000K

Coloris	Ref.	CHF
● noir 580lm 2700K	1006627	155.00
● noir 610lm 3000K	1006629	155.00
○ blanc 580lm 2700K	1006628	155.00
○ blanc 610lm 3000K	1006630	155.00



[1006633](tel:1006633) + [1006654](tel:1006654) [475+469](tel:475469)





IN-LINE 44 48V, opal, DALI



NEW

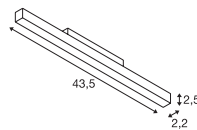

48V | 350mA
Puissance LED : 12W
Puissance totale : 14W
Matière : aluminium / polycarbonate (PC)



Down 1140lm | 2700K
1180lm | 3000K

Coloris	Ref.	CHF
● noir 1140lm 2700K	1006621	175.00
● noir 1180lm 3000K	1006623	175.00
○ blanc 1140lm 2700K	1006622	175.00
○ blanc 1180lm 3000K	1006624	175.00

IN-LINE 44 48V, Darklight Reflector, DALI



NEW

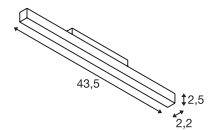

48V | 350mA
Puissance LED : 12W
Puissance totale : 14W
Matière : aluminium



Down 1180lm | 2700K
1230lm | 3000K

Coloris	Ref.	CHF
● noir 1180lm 2700K	1006633	190.00
● noir 1230lm 3000K	1006635	190.00
○ blanc 1180lm 2700K	1006634	190.00
○ blanc 1230lm 3000K	1006636	190.00

1006682 + 1006648 469 + 477





IN-LINE 24
48V, Move, Darklight Reflector, DALI



NEW

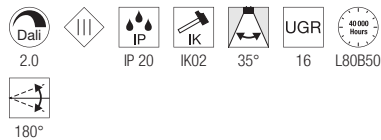
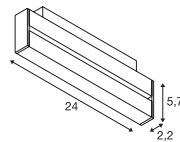

48V | 350mA
Puissance LED : 6W
Puissance totale : 7,3W
Matière : aluminium / polycarbonate (PC)



Down 580lm | 2700K
610lm | 3000K

Coloris	Ref.	CHF
● noir		
580lm 2700K	1006639	175.00
● noir		
610lm 3000K	1006641	175.00
○ blanc		
580lm 2700K	1006640	175.00
○ blanc		
610lm 3000K	1006642	175.00

IN-LINE 46
48V, Move, Darklight Reflector, DALI



NEW

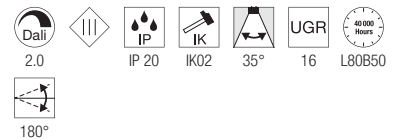
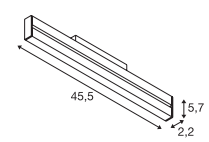

48V | 350mA
Puissance LED : 12W
Puissance totale : 14W
Matière : aluminium / polycarbonate (PC)



Down 1180lm | 2700K
1230lm | 3000K

Coloris	Ref.	CHF
● noir		
1180lm 2700K	1006645	205.00
● noir		
1230lm 3000K	1006647	205.00
○ blanc		
1180lm 2700K	1006646	205.00
○ blanc		
1230lm 3000K	1006648	205.00

CONFIGUREZ VOTRE 48V-SYSTEM

Choisissez le modèle de votre rail avec la longueur adéquate, la couleur que vous souhaitez et le type de montage que vous préférez. Optez pour la version encastrée ou l'une des deux versions en saillie. Les luminaires NUMINOS® et IN-LINE spécialement conçus pour le 48V-SYSTEM de SLV offrent une grande flexibilité et mettent parfaitement en scène votre espace.

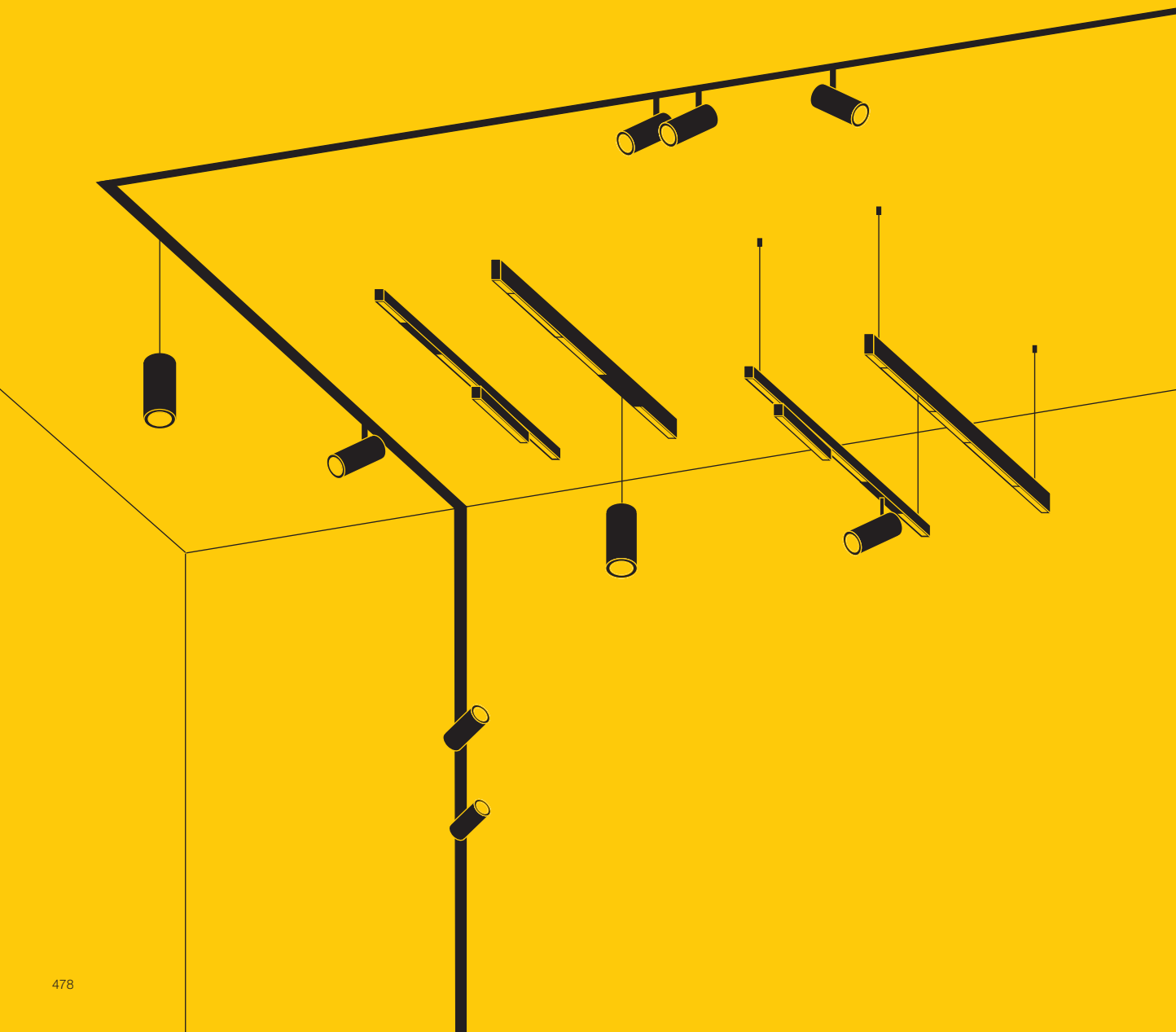

CHOISISSEZ VOTRE RAIL

RAIL EN SAILLIE
STANDARD



RAIL EN SAILLIE
PROFOND

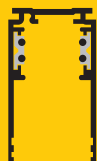

RAIL ENCASTRÉ

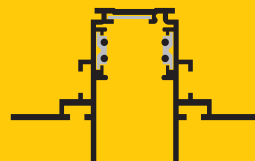

CHOISISSEZ LE TYPE DE MONTAGE QUE VOUS PRÉFÉREZ

EN SAILLIE

ENCASTRÉ



Plafond



Mur



Suspension



Plafond



Mur



CHOISISSEZ VOS LUMINAIRES

NUMINOS®
SPOTS ET SUSPENSIONS

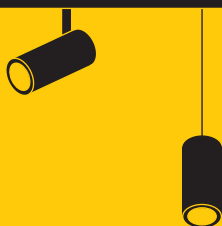

IN-LINE, IN-LINE DARKLIGHT REFLECTOR
ET IN-LINE MOVE



CHOISISSEZ VOS ACCESSOIRES

DRIVERS CONNECTEURS, CACHES, SUSPENSIONS, ADAPTATEURS SECTEUR, ET BIEN PLUS.

139100 489





SCKET

ASMARA | 486



SCKET

TELESKOP | 486



SCKET

COSMIC | 487



SCKET

SYROS | 489



SCKET

SALUNA | 489



LED

DURNO | 489



LED

PLYTTA | 490



LED

NOBLO® SPOT | 491



LED

COMET LED | 491



SCKET

COMET | 491

TENSEO, Câble T.B.T. 4 mm², 10 m



	10 m	10 m	10 m
Tension max. (V)	48	48	48
Intensité max. (A)	25	25	25
Coloris	● noir	○ blanc	○ transparent
Matière	Cuivre / plastique	Cuivre / plastique	Cuivre / plastique
Diamètre (cm) / longueur (cm)	0,4 / 1000	0,4 / 1000	0,4 / 1000
Ref.	1002602	1002603	1002604
CHF	26.65	26.65	26.65

TENSEO, Câble T.B.T. 4 mm², 20 m



	20 m	20 m	20 m
Tension max.	48	48	48
Intensité max. (A)	25	25	25
Coloris	● noir	○ blanc	○ transparent
Matière	Cuivre / plastique	Cuivre / plastique	Cuivre / plastique
Diamètre (cm) / longueur (cm)	0,4 / 2000	0,4 / 2000	0,4 / 2000
Ref.	139030	139031	139024
CHF	59.00	59.00	59.00

TENSEO, Câble T.B.T. 4 mm², 100 m

	100 m	100 m	100 m
Tension max. (V)	48	48	48
Intensité max. (A)	25	25	25
Coloris	● noir	○ blanc	○ transparent
Matière	Cuivre / plastique	Cuivre / plastique	Cuivre / plastique
Diamètre (cm) / longueur (cm)	0,4 / 10000	0,4 / 10000	0,4 / 10000
Ref.	139040	139041	139004
CHF	299.00	299.00	299.00

TENSEO, Câble T.B.T. 6 mm², 20 m

	20 m	20 m	20 m
Tension max. (V)	48	48	48
Intensité max. (A)	25	25	25
Coloris	● noir	○ blanc	○ transparent
Matière	Cuivre / plastique	Cuivre / plastique	Cuivre / plastique
Diamètre (cm) / longueur (cm)	0,6 / 2000	0,6 / 2000	0,6 / 2000
Ref.	139050	139051	139026
CHF	85.00	85.00	85.00

TENSEO, Câble T.B.T. 6 mm², 100 m

















	100 m	100 m	100 m
Tension max. (V)	48	48	48
Intensité max. (A)	25	25	25
Coloris	● noir	○ blanc	○ transparent
Matière	Cuivre / plastique	Cuivre / plastique	Cuivre / plastique
Diamètre (cm) / longueur (cm)	0,6 / 10000	0,6 / 10000	0,6 / 10000
Ref.	139060	139061	139006
CHF	349.00	349.00	349.00



139131 489



	<p>12V AC 50VA conventionnel Acier / laiton H : 11 cm Ø : 11,1 cm</p> <ul style="list-style-type: none"> ● noir Ref. 1002691 128.00 CHF ○ blanc Ref. 1002692 128.00 CHF ● chrome Ref. 1002693 128.00 CHF 		<p>12V AC 105VA conventionnel Acier / laiton H : 11 cm Ø : 11,1 cm</p> <ul style="list-style-type: none"> ○ blanc Ref. 138981 160.00 CHF ● chrome Ref. 138982 169.00 CHF
	<p>12V AC 210 VA conventionnel Acier / laiton H : 11 cm Ø : 13,5 cm</p> <ul style="list-style-type: none"> ○ blanc Ref. 138991 249.00 CHF ● chrome Ref. 138992 249.00 CHF 		<p>Tendeurs intermédiaires 25A max. laiton H : 11 cm Ø : 1 cm</p> <ul style="list-style-type: none"> ● noir Ref. 181530 33.00 CHF ○ blanc Ref. 181531 33.00 CHF ● chrome Ref. 181532 35.20 CHF
	<p>Support mural Acier / laiton L : 3 cm Ø : 5 cm</p> <ul style="list-style-type: none"> ● noir Ref. 186300 33.00 CHF ○ blanc Ref. 186301 33.00 CHF ● chrome Ref. 186302 35.20 CHF 		<p>Support de plafond 6 cm Acier / laiton H : 6 cm Ø : 5 cm</p> <ul style="list-style-type: none"> ● noir Ref. 186330 26.65 CHF ○ blanc Ref. 186331 26.65 CHF ● chrome Ref. 186332 33.00 CHF
	<p>Support de plafond Acier / laiton H : 16 cm Ø : 5 cm</p> <ul style="list-style-type: none"> ● noir Ref. 186340 33.00 CHF ○ blanc Ref. 186341 33.00 CHF ● chrome Ref. 186342 35.20 CHF 		<p>Support mural 10 cm Acier / laiton H : 11,5 cm Ø : 5 cm, avec tendeur</p> <ul style="list-style-type: none"> ● noir Ref. 186310 48.00 CHF ○ blanc Ref. 186311 48.00 CHF ● chrome Ref. 186312 49.10 CHF
	<p>Renvoi de plafond Acier / laiton H : 16 cm Ø : 5 cm</p> <ul style="list-style-type: none"> ● noir Ref. 186640 109.00 CHF ○ blanc Ref. 186641 109.00 CHF ● chrome Ref. 186642 109.00 CHF 		<p>Alimentation 25A max. laiton H : 1,8 cm Ø : 1 cm</p> <ul style="list-style-type: none"> ● noir Ref. 186350 14.90 CHF ○ blanc Ref. 186351 14.90 CHF ● chrome Ref. 186352 17.00 CHF
	<p>Connecteur isolé 25A max. aluminium / plastique L : 6,4 cm Ø : 1 cm</p> <ul style="list-style-type: none"> ● noir Ref. 186360 27.70 CHF ○ blanc Ref. 186361 27.70 CHF ● chrome Ref. 186362 27.70 CHF 		<p>Entretoises Aluminium l : 9 cm Ø : 1,25 cm</p> <ul style="list-style-type: none"> ● noir Ref. 1002700 55.00 CHF ○ blanc Ref. 1002701 55.00 CHF ● chrome Ref. 1002702 64.00 CHF
	<p>Entretoises avec connecteur 25A max. laiton H : 9 cm Ø : 1,25 cm</p> <ul style="list-style-type: none"> ● noir Ref. 1002703 67.00 CHF ○ blanc Ref. 1002704 67.00 CHF ● chrome Ref. 1002705 67.00 CHF 		<p>Kit de suspension 2 m Acier / aluminium l : 18,6 cm Ø : 1,25 cm</p> <ul style="list-style-type: none"> ● noir Ref. 1002697 49.10 CHF ○ blanc Ref. 1002698 49.10 CHF ● chrome Ref. 1002699 49.10 CHF



139071 486

ASMARA LV, QR-C51

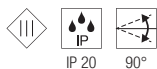
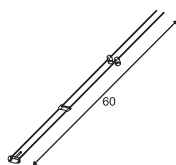

12V ~50Hz
Matière : acier inoxydable



Douille : 1xGX5.3

Coloris	Ref.	CHF
● noir	139070	33.00
○ blanc	139071	33.00
● chrome	139072	35.20



LED GU5.3 | 5,8W | 36°
2700K | 450lm | CEE=G
6kWh / 1000h

Ref. : 1001574 | 49.10 CHF



TELESKOP LV, QR-C51

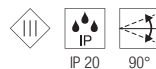

12V ~50Hz
Matière : acier



Douille : 1xGX5.3

Coloris	Ref.	CHF
● noir	139080	41.60
○ blanc	139081	41.60
● chrome	139082	45.90



LED GU5.3 | 5,8W | 36°
2700K | 450lm | CEE=G
6kWh / 1000h

Ref. : 1001574 | 49.10 CHF





COSMIC
LV, QR-C51



139090 487

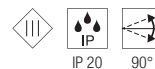
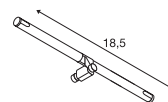

12V ~50Hz
Matière : acier / laiton



Douille : 1xGX5.3

Coloris	Ref.	CHF
● noir	139090	48.00
○ blanc	139091	48.00
● chrome	139092	49.10



LED GU5.3 | 5,8W | 36°
2700K | 450lm | CEE=G
6kWh / 1000h



Ref. : 1001574 | 49.10 CHF

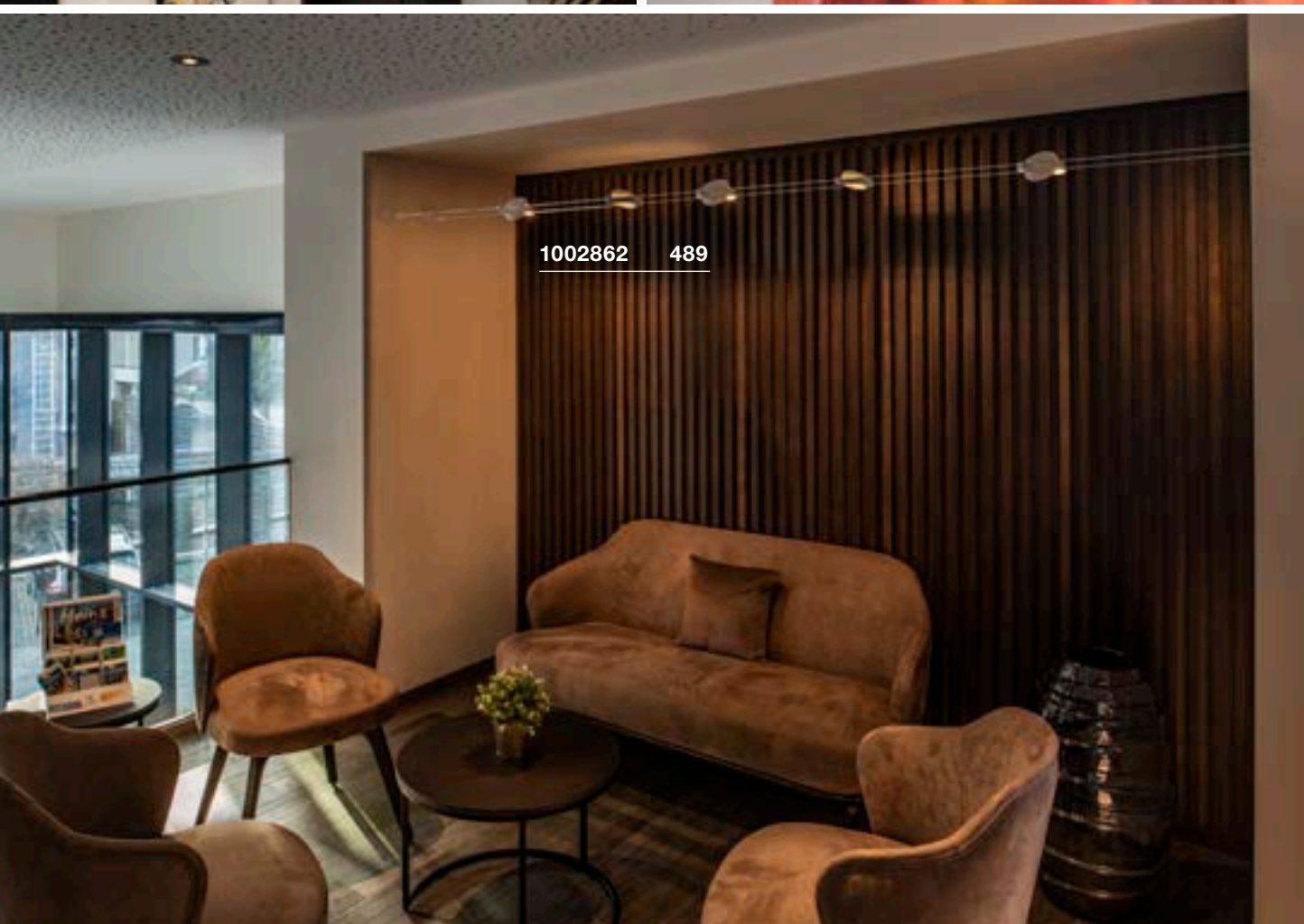
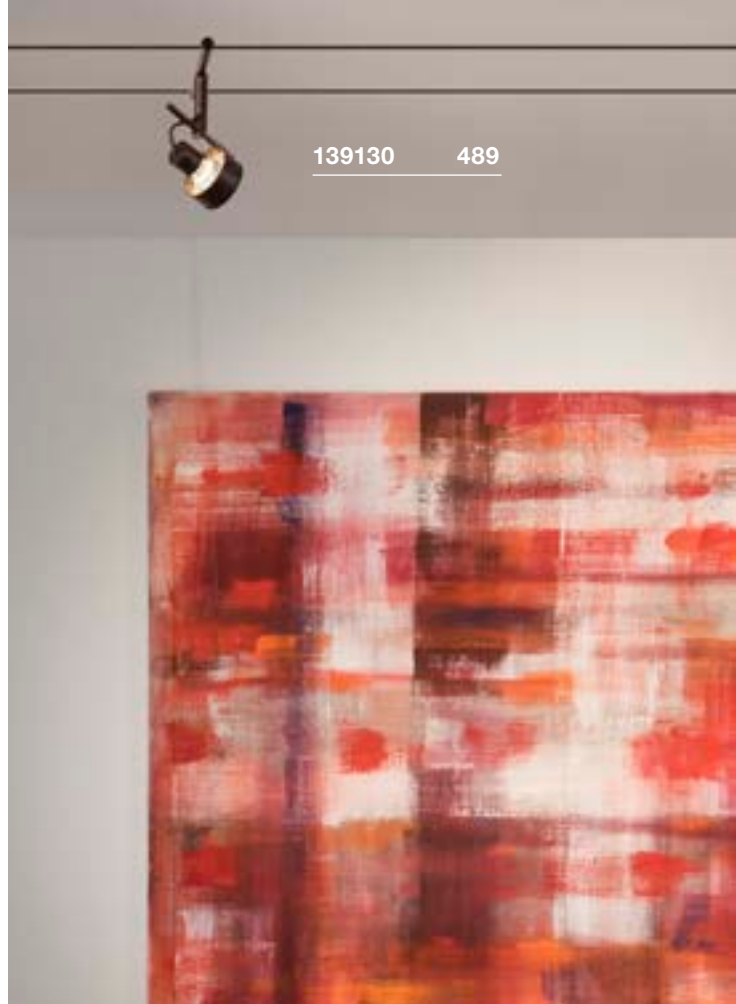



SYROS
LV, QR-C51

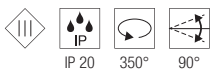
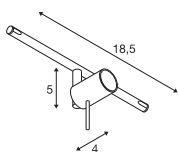

12V ~50Hz
Matière : acier



Douille : 1xGX5.3

Coloris	Ref.	CHF
● noir	139100	64.00
○ blanc	139101	64.00
● chrome	139102	72.00



LED GU5.3 | 5,8W | 36°
2700K | 450lm | CEE=G
6kWh / 1000h

Ref. : 1001574 | 49.10 CHF



SALUNA
LV, QR-C51

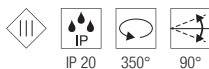
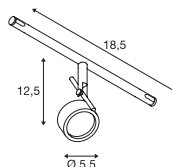

12V ~50Hz
Matière : acier / laiton



Douille : 1xGX5.3

Coloris	Ref.	CHF
● noir	139130	85.00
○ blanc	139131	85.00
● chrome	139132	99.00



LED GU5.3 | 5,8W | 36°
2700K | 450lm | CEE=G
6kWh / 1000h

Ref. : 1001574 | 49.10 CHF



DURNO
LV

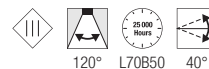
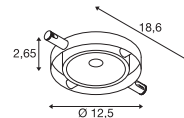

12V ~50Hz
Puissance totale : 6W
Matière : aluminium / acier inoxydable



Down

360lm | 2700K

Coloris	Ref.	CHF
● noir	1002861	99.00
○ blanc	1002862	99.00
● chrome / inox	1002863	106.00

1002864 490

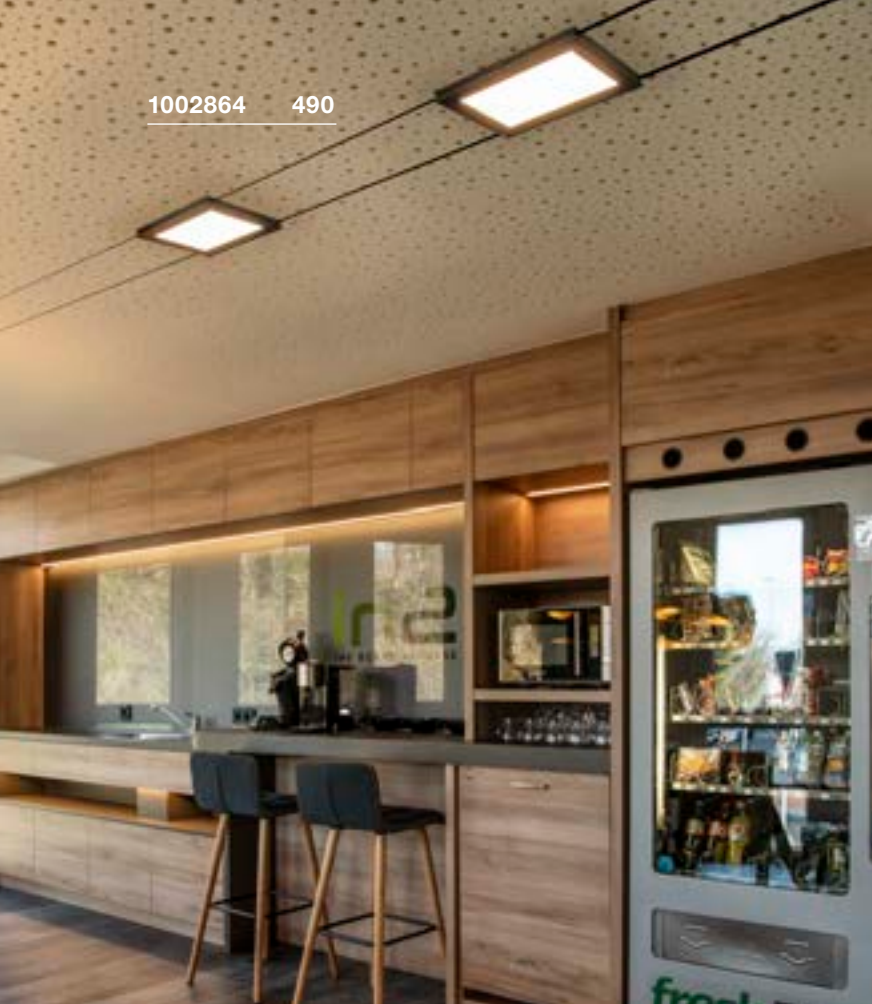

PLYTTA LV

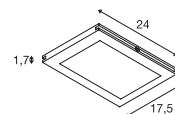

1002690 491

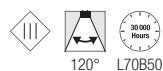

12V ~50Hz
Puissance totale : 9,8W
Matière : aluminium / plastique



Down

750lm | 2700K

Coloris	Ref.	CHF
● noir		
IRC80	1002864	85.00
○ blanc		
IRC90	1002865	85.00
● chrome		
IRC90	1002866	78.00



NOBLO® SPOT LV, Rope Track

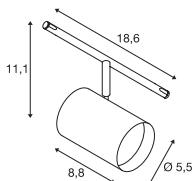

12V ~50Hz
Puissance totale : 8,5W
Matière : aluminium



Down 420lm | 2700K
450lm

Coloris	Ref.	CHF
● noir		
420lm	1002694	120.00
○ blanc		
450lm	1002695	120.00
● chrome		
450lm	1002696	120.00

COMET LED LV

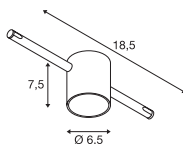

12V ~50Hz
Puissance totale : 6,6W
Matière : aluminium / verre



Down 410lm | 2700K

Coloris	Ref.	CHF
● chrome / dépoli	1002690	99.00

COMET LV, QR-C51

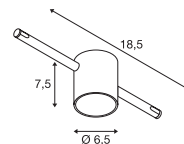

12V ~50Hz
Matière : laiton



Douille : 1xGX5.3

Coloris	Ref.	CHF
● noir	139120	64.00
○ blanc	139121	64.00
● chrome	139122	72.00



LED GU5.3 | 5,8W | 36°
2700K | 450lm | CEE=G
6kWh / 1000h

Ref. : **1001574** | **49.10 CHF**



1007354 503





NEW

LED
NOBLO® SPOT | 501



NEW

LED
NOBLO® SPOT | 501



NEW

LED
NOBLO® SPOT | 503



NEW

LED
NOBLO® SPOT | 503

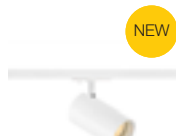

NEW

SCKET
ASTO TUBE | 505



NEW

SCKET
PANTILO
ROPE 19 | 505



LED
HELIA 50 TRACK | 507



LED
PANEL TRACK | 507



LED
PANEL TRACK | 507



SCKET
PARA CONE GL | 508



SCKET
PARA CONE GL | 508



SCKET
PARA CONE 14 | 509



SCKET
PARA CONE 14 | 509



SCKET
TONGA® | 511



SCKET
LIGHT EYE® 90 | 511



SCKET
LIGHT EYE® 150 | 511



SCKET
FORCHINI M 40
TRACK | 512



SCKET
PURI TRACK | 513



SCKET
PURI TRACK | 513



SCKET
PURI TRACK | 515



SCKET
AVO TRACK | 515



LED
ENOLA C TRACK | 516



LED
ENOLA C TRACK | 517



SCKET
ENOLA B TRACK | 517



SCKET
ENOLA B | 517



SCKET
BIMA | 519



SCKET
BIMA | 519



LED
KALU TRACK | 520



SCKET
KALU TRACK | 520



SCKET
EURO SPOT
TRACK | 521



SCKET
ALTRA DICE
TRACK | 521

1000713 511



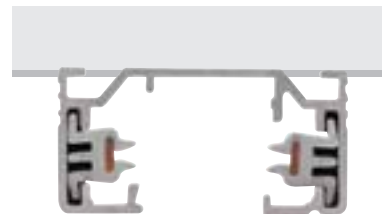

RAIL 1 ALLUMAGE

EN SAILLIE



	1 m	1 m	1 m
Tension nominale (V)	220-240V ~50/60Hz	250V ~50/60Hz	220-240V ~50/60Hz
Intensité max. (A)	16	16	16
Coloris	● noir	○ blanc	● gris
Matière	Aluminium	Aluminium	Aluminium
L x l x H (cm)	100 x 3,5 x 1,8	100 x 3,5 x 1,8	100 x 3,5 x 1,8
Ref.	143010	143011	143012
CHF	42.65	42.65	42.65

	2 m	2 m	2 m
Tension nominale (V)	220-240V ~50/60Hz	250V ~50/60Hz	220-240V ~50/60Hz
Intensité max. (A)	16	16	16
Coloris	● noir	○ blanc	● gris
Matière	Aluminium	Aluminium	Aluminium
L x l x H (cm)	200 x 3,5 x 1,8	200 x 3,5 x 1,8	200 x 3,5 x 1,8
Ref.	143020	143021	143022
CHF	85.00	85.00	85.00

	3 m	3 m	3 m
Tension nominale (V)	250V ~50/60Hz	250V ~50/60Hz	250V ~50/60Hz
Intensité max. (A)	16	16	16
Coloris	● noir	○ blanc	● gris
Matière	Aluminium	Aluminium	Aluminium
L x l x H (cm)	300 x 3,5 x 1,8	300 x 3,5 x 1,8	300 x 3,5 x 1,8
Ref.	1002151	1002152	1002153
CHF	127.00	127.00	127.00

1 ALLUMAGE

Rail en saillie

Outil de configuration et accessoires en un seul coup d'œil

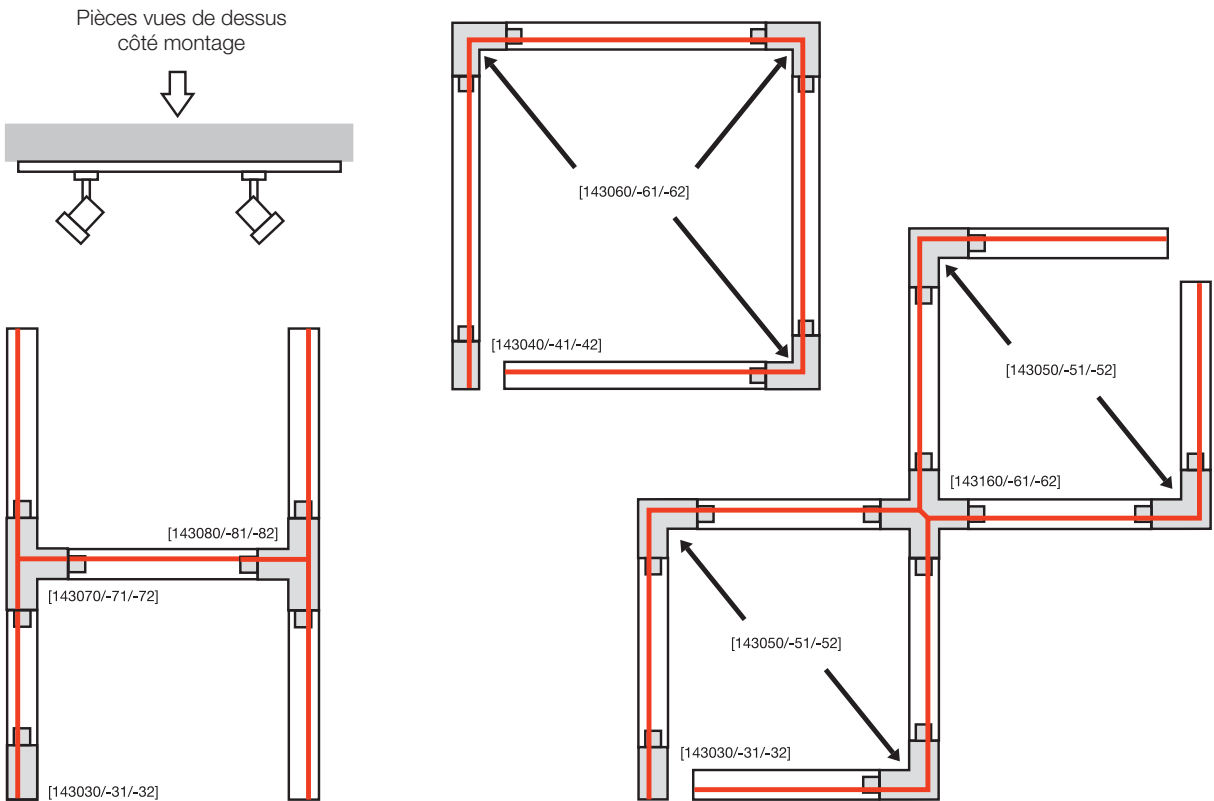



Alimentation, terre à gauche
16A max. | polycarbonate (PC)
L : 6,5 cm | l : 3,5 cm | H : 1,8 cm

● noir	Ref.	143030	12.75 CHF
○ blanc		143031	12.75 CHF
● gris		143032	12.75 CHF

Stabilisateur, connecteur longitudinal long
Acier
L : 19,7 cm | l : 3,2 cm | H : 1,3 cm Pour une meilleure rigidité en cas d'installation de plusieurs rails avec la suspension de plafond (1002845)

● nickel	Ref.	143151	9.50 CHF
----------	------	--------	----------

Alimentation, terre à droite
16A max. | polycarbonate (PC)
L : 6,5 cm | l : 3,5 cm | H : 1,8 cm

● noir	Ref.	143040	12.75 CHF
○ blanc		143041	12.75 CHF
● gris		143042	12.75 CHF

Stabilisateur, connecteur d'angle long
Acier
L : 11,5 cm | l : 11,5 cm | H : 0,5 cm Pour une meilleure rigidité en cas d'installation de plusieurs rails avec la suspension de plafond (1002845)

● nickel	Ref.	143152	10.60 CHF
----------	------	--------	-----------

Connecteur longitudinal avec possibilité d'alimentation 16A max. | polycarbonate (PC)
L : 17,2 cm | l : 3,5 cm | H : 1,8 cm

● noir	Ref.	143100	21.30 CHF
○ blanc		143101	21.30 CHF
● gris		143102	21.30 CHF

Stabilisateur, connecteur en X
Acier
L : 19,7 cm | l : 19,7 cm | H : 0,5 cm Pour une meilleure rigidité en cas d'installation de plusieurs rails avec la suspension de plafond (1002845).

● gris	Ref.	143169	14.90 CHF
--------	------	--------	-----------

Connecteur longitudinal, électrique
16A max. | polycarbonate (PC)
L : 6,4 cm | l : 3,5 cm | H : 1,8 cm

● noir	Ref.	143090	9.50 CHF
○ blanc		143091	9.50 CHF
● gris		143092	9.50 CHF

Adaptateur 1 allumage
6A max. | polycarbonate (PC)
L : 8,5 cm | l : 3,5 cm | H : 3,2 cm

● noir	Ref.	143120	17.00 CHF
○ blanc		143121	17.00 CHF
● gris		143124	17.00 CHF

Connecteur d'angle, terre intérieure
16A max. | polycarbonate (PC)
L : 10,4 cm | l : 10,4 cm | H : 1,8 cm

● noir	Ref.	143060	20.20 CHF
○ blanc		143061	20.20 CHF
● gris		143062	20.20 CHF

Adaptateur 1 allumage, avec crochet
6A max. | polycarbonate (PC)
L : 8,5 cm | l : 3,5 cm | H : 7,4 cm

● noir	Ref.	143170	17.00 CHF
○ blanc		143171	17.00 CHF
● gris		143172	17.00 CHF

Connecteur d'angle, terre extérieure
16A max. | polycarbonate (PC)
L : 10,4 cm | l : 10,4 cm | H : 1,8 cm

● noir	Ref.	143050	20.20 CHF
○ blanc		143051	20.20 CHF
● gris		143052	20.20 CHF

Cache
Polycarbonate (PC)
L : 200 cm | l : 1,8 cm | H : 0,75 cm

● noir	Ref.	1004783	25.55 CHF
○ blanc		1004785	25.55 CHF
● gris		1004784	25.55 CHF

Connecteur en T, terre extérieure, à gauche
16A max. | polycarbonate (PC)
L : 17,2 cm | l : 10,4 cm | H : 1,8 cm

● noir	Ref.	143070	24.50 CHF
○ blanc		143071	24.50 CHF
● gris		143072	24.50 CHF

Embout (2 pièces)
Polycarbonate (PC)
L : 0,4 cm | l : 3,5 cm | H : 1,8 cm

● noir	Ref.	143130	4.10 CHF
○ blanc		143131	4.10 CHF
● gris		143132	4.10 CHF

Connecteur en T, terre extérieure, à droite
16A max. | polycarbonate (PC)
L : 17,2 cm | l : 10,4 cm | H : 1,8 cm

● noir	Ref.	143080	24.50 CHF
○ blanc		143081	24.50 CHF
● gris		143082	24.50 CHF

Patère
6A max. | polycarbonate (PC)
H : 2,5 cm Ø : 11,5 cm

● noir	Ref.	143380	24.50 CHF
○ blanc		143381	24.50 CHF
● gris		143382	24.50 CHF

Connecteur en X
16A max. | polycarbonate (PC)
L : 9,5 cm | l : 17,2 cm | H : 1,8 cm

● noir	Ref.	143160	35.20 CHF
○ blanc		143161	35.20 CHF
● gris		143162	35.20 CHF

Suspension à câbles métalliques (2 pièces)
Acier inoxydable / laiton
L : 500 cm

● nickel	Ref.	1002845	55.00 CHF
----------	------	---------	-----------

Connecteur flexible
16A max. | polycarbonate (PC)
L : 16,4 cm | l : 3,5 cm | H : 1,8 cm

● noir	Ref.	143110	21.30 CHF
○ blanc		143111	21.30 CHF
● gris		143112	21.30 CHF

143580 507





1 ALLUMAGE

Encastrable avec accessoires compatibles

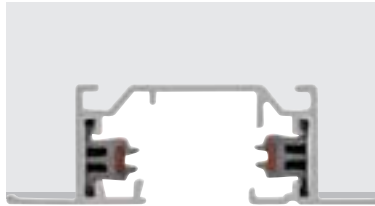

	2 m
Tension nominale (V)	250V ~50/60Hz
Intensité max. (A)	16
Coloris	○ blanc
Matière	Aluminium
L x l x H (cm)	200 x 5,5 x 1,8
Ref.	143221
CHF	85.00



Alimentation, terre à gauche
16A max. | plastique
L : 10,8 cm | l : 5,5 cm | H : 2 cm

○ blanc Ref. **143231** **17.00 CHF**



Embout
Plastique
L : 2,7 cm | l : 5,5 cm | H : 1,8 cm

○ blanc Ref. **143281** **9.50 CHF**



Alimentation, terre à droite
16A max. | plastique
L : 10,8 cm | l : 5,5 cm | H : 2 cm

○ blanc Ref. **143241** **17.00 CHF**



Étrier de fixation
Acier
L : 7,5 cm | l : 1,5 cm | H : 4 cm

● nickel Ref. **143230** **4.10 CHF**



Connecteur longitudinal avec renfort mécanique
16A max. | plastique / acier
L : 6,5 cm | l : 1,8 cm | H : 1,7 cm

○ blanc Ref. **143271** **17.00 CHF**



Adaptateur 1 allumage, avec crochet
6A max. | polycarbonate (PC)
L : 8,5 cm | l : 3,5 cm | H : 7,4 cm

● noir Ref. **143170** **17.00 CHF**
○ blanc **143171** **17.00 CHF**
● gris **143172** **17.00 CHF**



Connecteur d'angle, terre intérieure
16A max. | plastique
L : 11,2 cm | l : 11,2 cm | H : 2 cm

○ blanc Ref. **143261** **24.50 CHF**



Adaptateur 1 allumage
6A max. | polycarbonate (PC)
L : 8,5 cm | l : 3,5 cm | H : 3,2 cm

● noir Ref. **143120** **17.00 CHF**
○ blanc **143121** **17.00 CHF**
● gris **143124** **17.00 CHF**



Connecteur d'angle, terre extérieure
16A max. | plastique
L : 11,2 cm | l : 11,2 cm | H : 2 cm

○ blanc Ref. **143251** **27.70 CHF**

1007639 501





NOBLO® SPOT
1 all., Triple Track Set

NOBLO® SPOT
1 all., PHASE

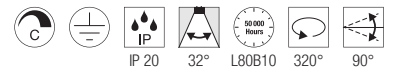
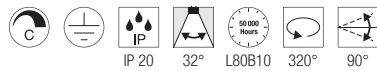
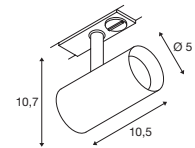
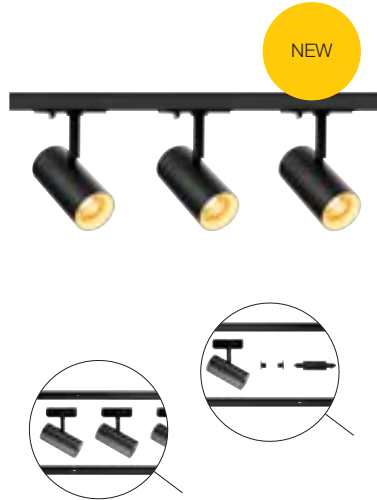

220-240V ~50/60Hz | 150mA
Puissance totale : 19W
Matière : aluminium

220-240V ~50/60Hz | 150mA
Puissance totale : 6,2W
Matière : aluminium / polycarbonate (PC)



Down 2250lm | 2700K



Down 740lm | 2700K

Coloris	Ref.	CHF
● noir	1007673	293.30
○ blanc	1007674	293.30

Coloris	Ref.	CHF
● noir	1007638	80.50
○ blanc	1007639	80.50
● gris	1007640	80.50

1007352 503





NOBLO® SPOT
1 all., PHASE



NOBLO® SPOT
1 all., PHASE

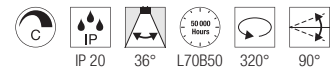
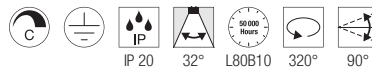
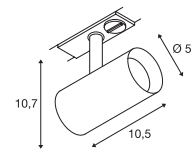
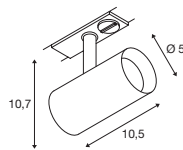

220-240V ~50/60Hz | 150mA
Puissance totale : 6,2W
Matière : aluminium / polycarbonate (PC)

220-240V ~50/60Hz | 350mA
Puissance totale : 8,4W
Matière : aluminium / polycarbonate (PC)



Down 750lm | 3000K



Down 30lm | 2000K - 450lm | 3000K

Coloris	Ref.	CHF
● noir	1007641	80.50
○ blanc	1007642	80.50
● gris	1007643	80.50

Coloris	Ref.	CHF
● noir	1007352	97.80
○ blanc	1007353	97.80
● gris	1007354	97.80

1006445 505





ASTO TUBE 1 all., GU10



ASTO TUBE Réflecteur déco



H : 3,95 cm
Ø : 6,75 cm
Matière : polycarbonate (PC)

PANTILO ROPE 19 PD, E27

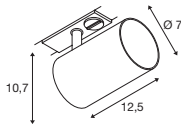

Coloris	Ref.	CHF
● noir / chrome	1007190	5.20
● or	1006450	5.20
● chrome	1006449	5.20
● cuivre	1006451	5.20

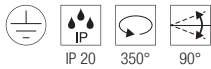
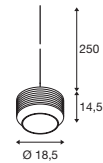

220-240V ~50/60Hz
Matière : aluminium



Douille : 1xGU10

Coloris	Ref.	CHF
● noir	1006445	86.90
○ blanc	1006446	86.90



LED GU10 51mm | 6W | 38°
2700K | 450lm | CEE=F
6kWh / 1000h



Ref. : 1005077 | 10.60 CHF

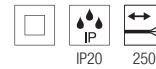

200-240V ~50/60Hz
Matière : verre / acier / chanvre

• Câble nu



Douille : 1xE27 Ø max. : 10 cm L : 11 cm

Coloris	Ref.	CHF
● ambre / or	1007597	228.90
● anthracite / argent	1007596	228.90



A60 | 7,5W | 180°
2700K | 720lm | CEE=F
8kWh / 1000h



Ref. : 1005305 | 24.50 CHF

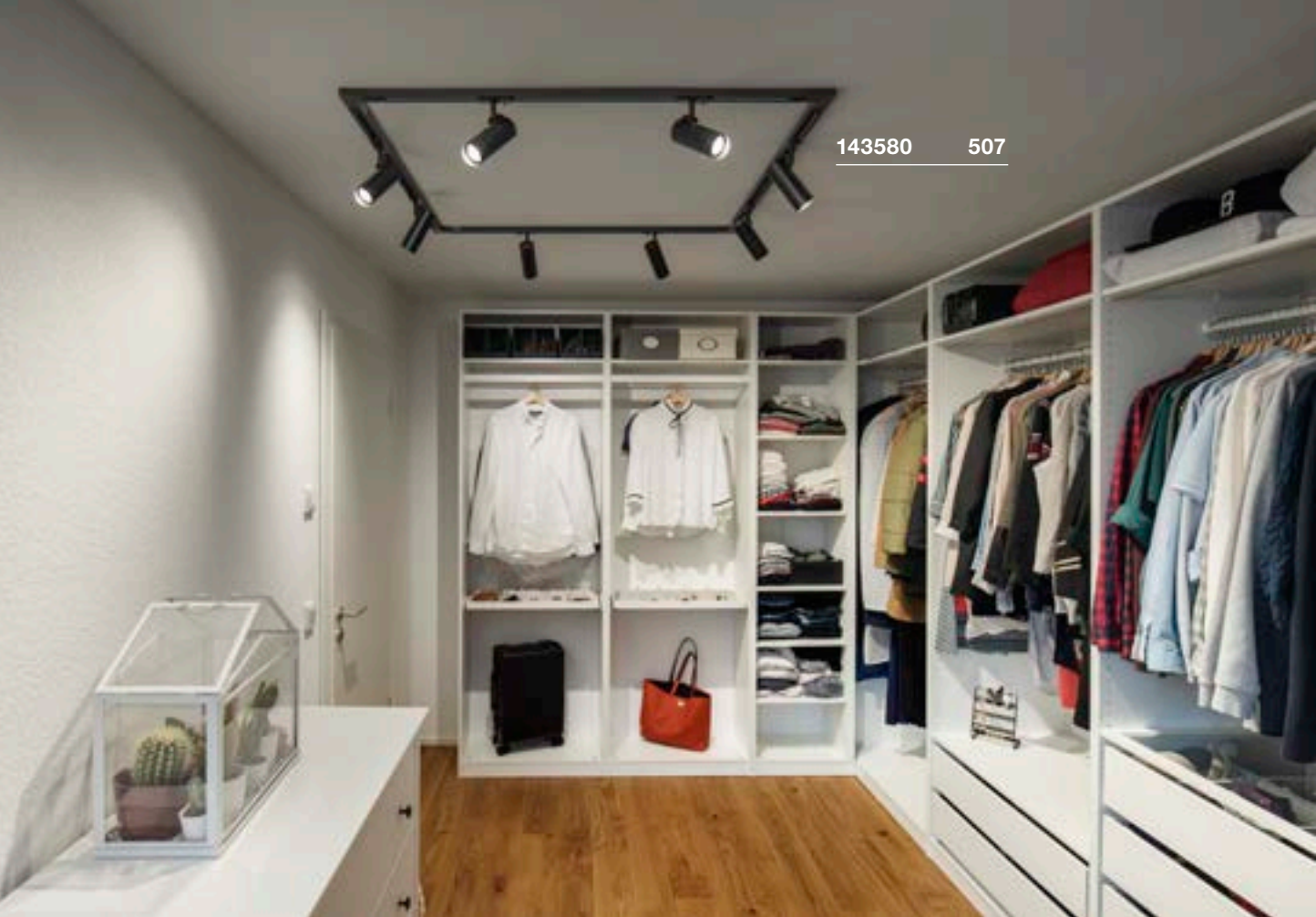



HELIA 50 TRACK
1 all.

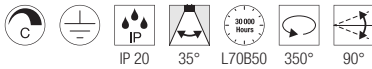
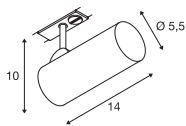

220-240V ~50/60Hz | 500mA
Puissance totale : 11W
Matière : aluminium



Down 810lm | 880lm | 3000K

Coloris	Ref.	CHF
● noir		
810lm	143580	156.00
○ blanc		
880lm	143581	156.00

PANEL TRACK
1 all., rectangulaire

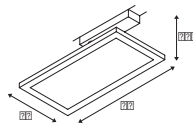

220-240V ~50/60Hz | 450mA
Puissance totale : 18W
Matière : polycarbonate (PC) / acier



Down 1800lm | 3000K

Coloris	Ref.	CHF
● noir	1004933	125.00
○ blanc	1004934	125.00

PANEL TRACK
1 all., rond

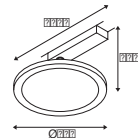

220-240V ~50/60Hz | 450mA
Puissance totale : 18W
Matière : polycarbonate (PC) / acier



Down 1800lm | 3000K

Coloris	Ref.	CHF
● noir	1004935	125.00
○ blanc	1004936	125.00

PARA CONE GL
1 all., GU10

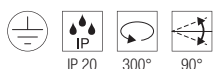
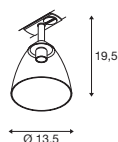

220-240V ~50/60Hz
Matière : aluminium / verre



Douille : 1xGU10

Coloris	Ref.	CHF
● noir	1006155	109.00
○ blanc	1006156	109.00



LED GU10 51mm | 3,2W
2700K | 270lm | CEE=G



Ref. : 1006321 | 55.20 CHF

PARA CONE GL
PD, GU10

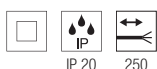
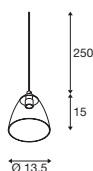

220-240V ~50/60Hz
Matière : aluminium / verre

• Câble nu



Douille : 1xGU10

Coloris	Ref.	CHF
● noir	1006159	109.00
○ blanc	1006160	109.00



LED GU10 51mm | 3,2W
2700K | 270lm | CEE=G



Ref. : 1006321 | 55.20 CHF



Article	Ref.	CHF
Adaptateur 1 allumage		
● noir	143120	17.00
○ blanc	143121	17.00
● gris	143124	17.00

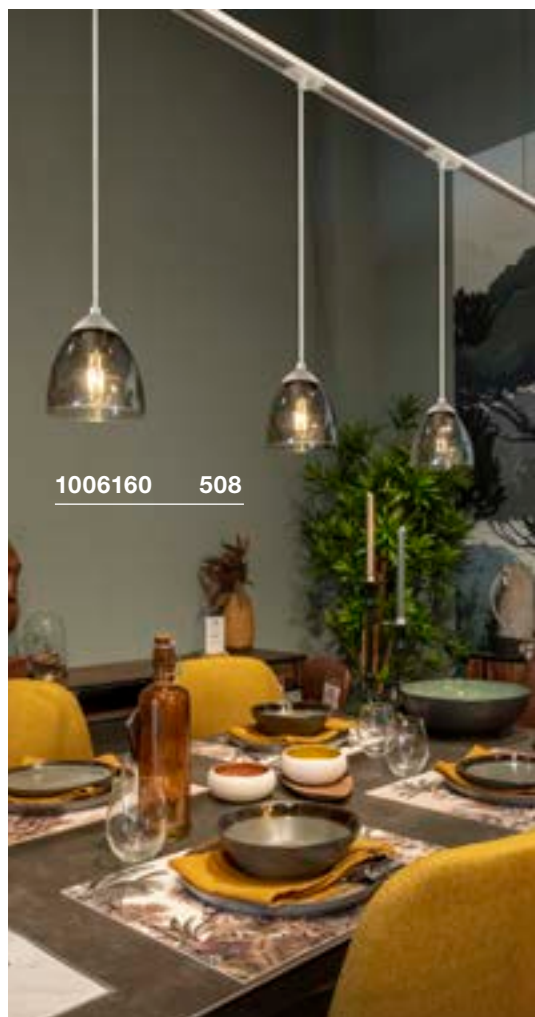

1006160 508



1006155 508

PARA CONE 14
1 all., QPAR51

PARA CONE 14
1 all., PD, QPAR51

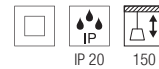
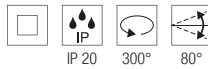
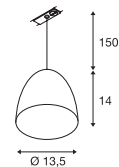
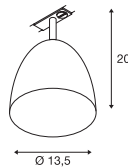

220-240V ~50/60Hz
Matière : acier

220-240V ~50/60Hz
Matière : aluminium

- Câble textile
- Version noir/or avec réflecteur doré
- Toutes les autres versions présentent le réflecteur blanc



1002875 509



Douille : 1xGU10

Douille : 1xGU10

Coloris	Ref.	CHF
● noir	1002873	109.00
○ blanc	1002874	109.00
● cuivre	1002875	117.00

Coloris	Ref.	CHF
● noir	143990	138.00
○ blanc	143991	138.00
● cuivre	1001968	138.00



LED GU10 51mm | 3,2W
2700K | 270lm | CEE=G



Ref. : 1006321 | 55.20 CHF



LED GU10 51mm | 3,2W
2700K | 270lm | CEE=G



Ref. : 1006321 | 55.20 CHF



143594

511



144011

511



1000713

511



TONGA®
1 all., PD, E14

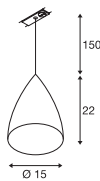

220-240V ~50/60Hz
Matière : aluminium / verre



Douille : 1xE14 Ø max. : 5,1 cm L : 13 cm

Coloris	Ref.	CHF
● gris / blanc opale	143594	160.00



C35 | 4,2W | 320°
2700K | 350lm | CEE=G
5kWh / 1000h



Ref. : **1005285** | **12.90 CHF**

LIGHT EYE® 90
1 all., QPAR51

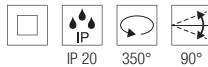
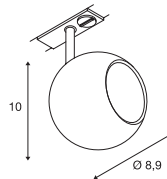

230V ~50/60Hz
Matière : acier



Douille : 1xGU10

Coloris	Ref.	CHF
● noir	144010	96.00
○ blanc	144011	96.00
● cuivre	144019	117.00



LED GU10 51mm | 6W | 36°
2200-2700K | 360lm | CEE=G
6kWh / 1000h



Ref. : **1005273** | **12.90 CHF**

LIGHT EYE® 150
1 all., PD, QPAR111

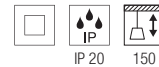
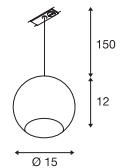

220-240V ~50/60Hz
Matière : acier



Douille : 1xGU10

Coloris	Ref.	CHF
● noir	1000713	156.00
○ blanc	143621	160.00



LED GU10 51mm | 6W | 38°
2700K | 450lm | CEE=F
6kWh / 1000h



Ref. : **1005077** | **10.60 CHF**

FORCHINI M 40 TRACK
1 all., E27

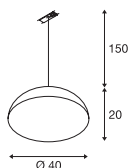

143932 512

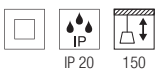

220-240V ~50/60Hz
Matière : aluminium / acier

- Adaptateur pour suspension coloris gris argent [143930] / noir [143932]

SOCKET INSIDE <40 W

Douille : 1xE27 Ø max. : 6,8 cm L : 15,2 cm

Coloris	Ref.	CHF
● noir / or	143930	259.00
● noir / or	143932	259.00



A60 | 7,5W | 180°
2700K | 720lm | CEE=F
8kWh / 1000h



Ref. : 1005305 | 24.50 CHF



1001868 513



PURI TRACK
1 all., Triple Track Set

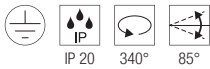
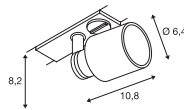
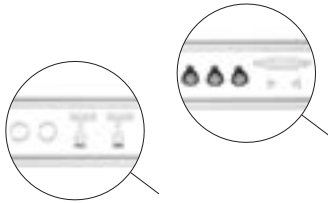

220-240V ~50/60Hz
Puissance totale : 4,3W
Matière : aluminium

- Composé de 2 rails 1 m,
1 connecteur longitudinal avec alimentation,
2 embouts,
3 spots PURI,
3 sources LED GU10,
3 anneaux déco pour GU10

PURI TRACK
1 all., QPAR51

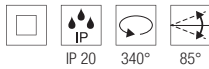
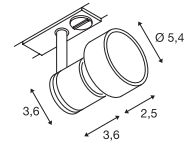

220-240V ~50/60Hz
Matière : aluminium / plastique



Douille : 1xGU10

PURI TRACK
1 all., QPAR51

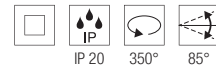

220-240V ~50/60Hz
Matière : aluminium / polycarbonate (PC)

- Anneau déco inclus



Douille : 1xGU10

Coloris	Ref.	CHF
● noir	143190	229.00
○ blanc	143191	229.00

Coloris	Ref.	CHF
● noir	1001868	56.00
○ blanc	1001869	56.00

Coloris	Ref.	CHF
● noir	143390	45.90
○ blanc	143391	45.90
● gris	143392	45.90



LED GU10 51mm | 6W | 38°
2700K | 450lm | CEE=F
6kWh / 1000h



Ref. : 1005077 | 10.60 CHF



LED GU10 51mm | 6W | 38°
2700K | 450lm | CEE=F
6kWh / 1000h



Ref. : 1005075 | 10.60 CHF

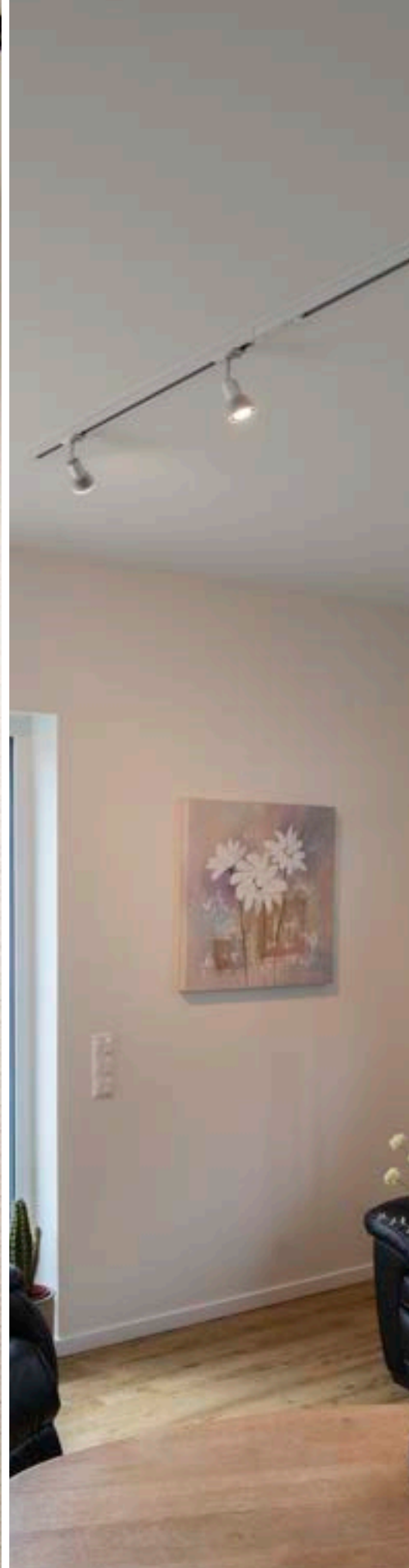

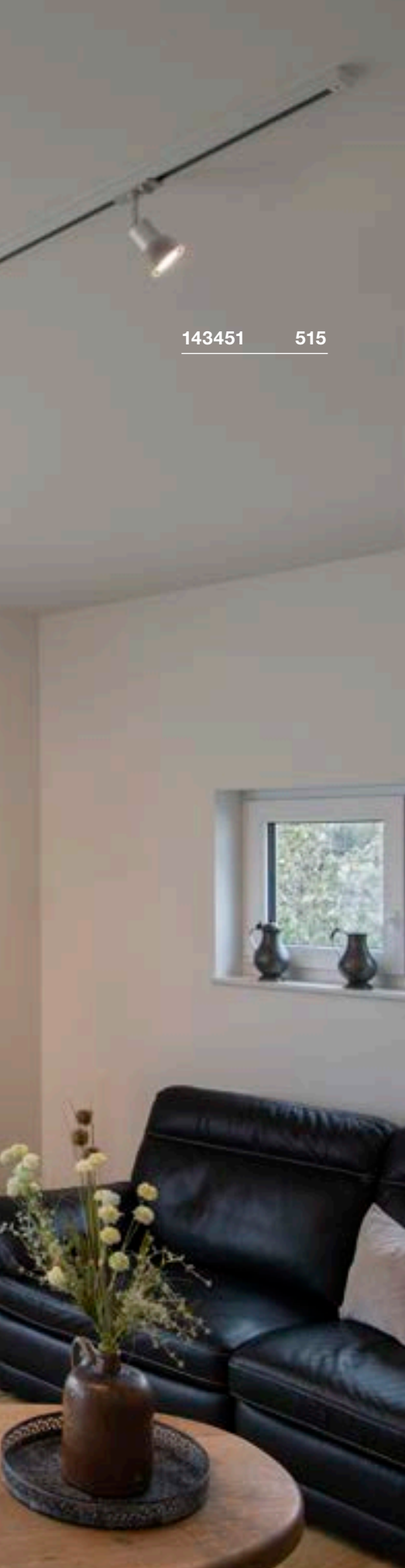

143451 515

PURIA TRACK 1 all., QPAR51

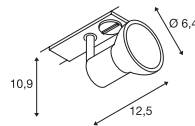

220-240V ~50/60Hz
Matière : aluminium / plastique



Douille : 1xGU10

Coloris	Ref.	CHF
● noir	143450	55.00
○ blanc	143451	55.00
● gris	143454	55.00



LED GU10 51mm | 6W | 36°
2200-2700K | 360lm | CEE=G
6kWh / 1000h



Ref. : 1005273 | 12.90 CHF

AVO TRACK 1 all., QPAR51

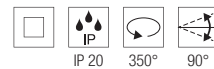
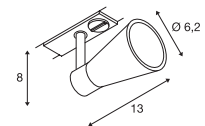

220-240V ~50/60Hz
Matière : acier



Douille : 1xGU10

Ø max. : 5,1 cm

Coloris	Ref.	CHF
● noir	144200	48.00
○ blanc	144201	48.00
● gris	144204	48.00



LED GU10 51mm | 6W | 38°
2700K | 450lm | CEE=F
6kWh / 1000h



Ref. : 1005077 | 10.60 CHF

ENOLA C TRACK

1 all.

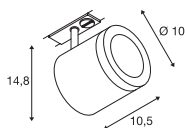

220-240V ~50/60Hz | 500mA
 Puissance totale : 11W
 Matière : aluminium / verre



Down 1040lm | 3000K

Coloris	Ref.	CHF
● noir	1000711	239.00
○ blanc	143941	229.00



143941 516

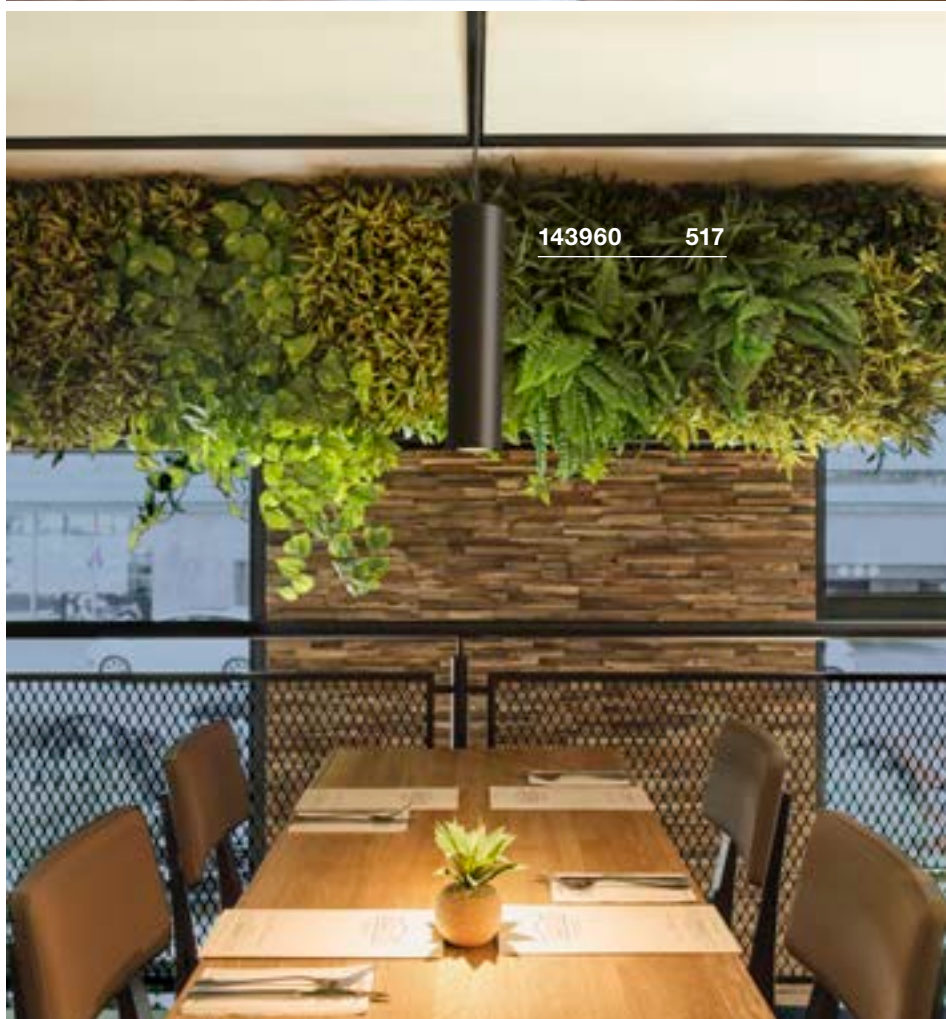

143960 517



ENOLA C TRACK 1 all.

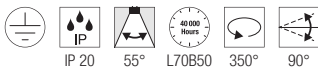
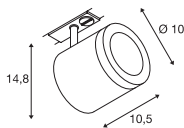

220-240V ~50/60Hz | 500mA
Puissance totale : 11W
Matière : aluminium / verre



Down 1040lm | 3000K

Coloris	Ref.	CHF
● noir	1000712	239.00
○ blanc	143951	229.00

ENOLA B TRACK 1 all., QPAR51

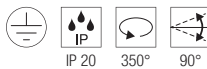
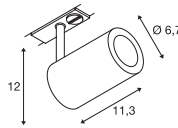

220-240V ~50/60Hz
Matière : aluminium / acier



Douille : 1xGU10 Ø max. : 5,1 cm | L : 6,7 cm

Coloris	Ref.	CHF
● noir	1002110	99.00
○ blanc	1002111	99.00
● gris	1002113	99.00



LED GU10 51mm | 6W | 38°
2700K | 450lm | CEE=F
6kWh / 1000h



Ref. : 1005075 | 10.60 CHF

ENOLA B PD, QPAR51

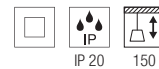
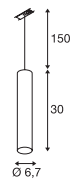

220-240V ~50/60Hz
Matière : aluminium / acier



Douille : 1xGU10

Coloris	Ref.	CHF
● noir	143960	160.00
○ blanc	143961	160.00



LED GU10 51mm | 6W | 38°
2700K | 450lm | CEE=F
6kWh / 1000h



Ref. : 1005077 | 10.60 CHF

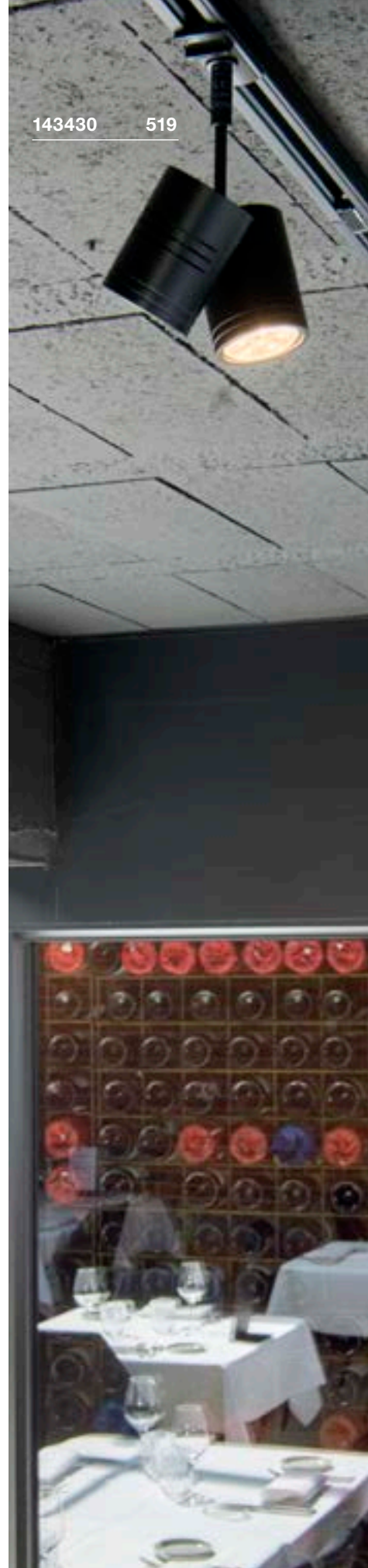



BIMA
1 all., simple, QPAR51

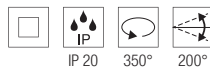
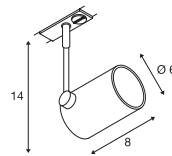

220-240V ~50/60Hz
Matière : aluminium



Douille : 1xGU10 Ø max. : 5,1 cm L : 5,7 cm

Coloris	Ref.	CHF
● noir	143440	64.00
○ blanc	143441	64.00
● gris	143442	64.00



LED GU10 51mm | 6W | 38°
2700K | 450lm | CEE=F
6kWh / 1000h



Ref. : 1005075 | 10.60 CHF

BIMA
1 all., double, QPAR51

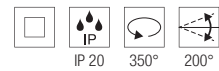
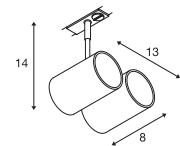

220-240V ~50/60Hz
Matière : aluminium



Douilles : 2xGU10 Ø max. : 5,1 cm L : 5,7 cm

Coloris	Ref.	CHF
● noir	143430	106.00
○ blanc	143431	106.00
● gris	143432	106.00



LED GU10 51mm | 6W | 38°
2700K | 450lm | CEE=F
6kWh / 1000h



Ref. : 1005077 | 10.60 CHF



KALU TRACK
1 all., PHASE

KALU TRACK
1 all., QPAR111

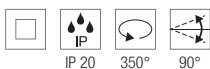
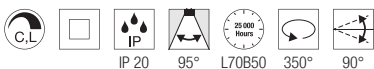
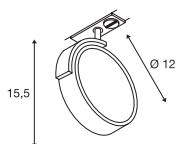
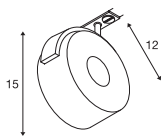

220-240V ~50/60Hz
Puissance totale : 13W
Matière : aluminium

220-240V ~50/60Hz
Matière : aluminium / plastique



Down 970lm | 3000K



Douille : 1xGU10

Coloris	Ref.	CHF
● noir	1002854	259.00
○ blanc	143731	269.00

Coloris	Ref.	CHF
● noir	143540	106.00
○ blanc	143541	106.00
● gris	143544	106.00



QPAR111 | 12,5W | 10°
3000K | 950lm | CEE=F
13kWh / 1000h



Ref. : 1005278 | 65.00 CHF

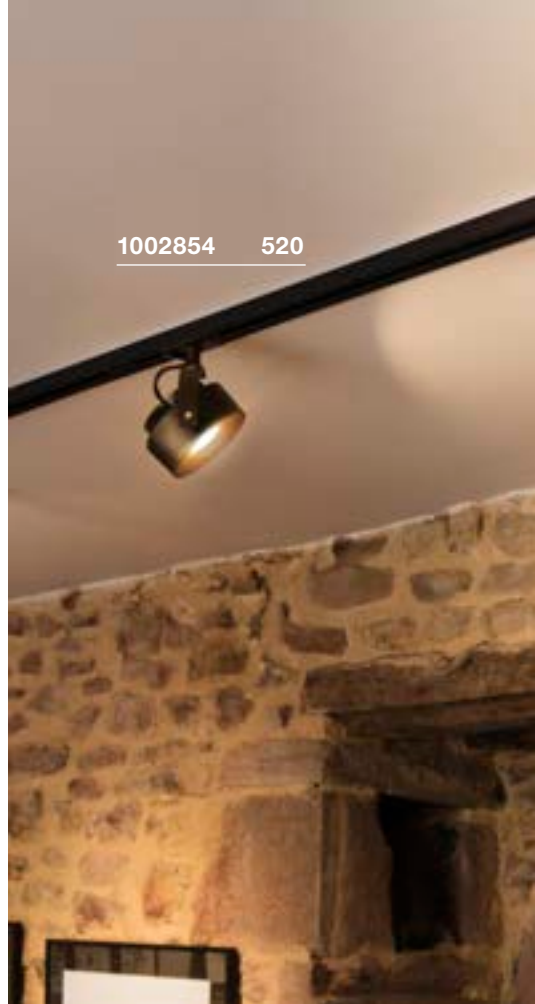



EURO SPOT TRACK
1 all., QPAR51

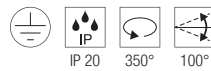
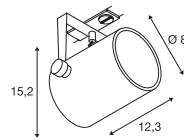

220-240V ~50/60Hz
Matière : aluminium



Douille : 1xGU10

Coloris	Ref.	CHF
● noir	1001861	96.00
○ blanc	143811	94.00



LED GU10 51mm | 6W | 38°
2700K | 450lm | CEE=F
6kWh / 1000h



Ref. : 1005077 | 10.60 CHF

ALTRA DICE TRACK
1 all., QPAR51

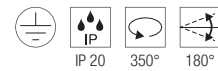
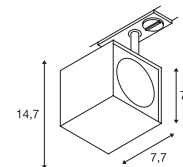

220-240V ~50/60Hz
Matière : aluminium



Douille : 1xGU10

Coloris	Ref.	CHF
● noir	143350	125.00
○ blanc	143351	125.00
● gris	143354	125.00



LED GU10 51mm | 6W | 36°
2200-2700K | 360lm | CEE=G
6kWh / 1000h



Ref. : 1005273 | 12.90 CHF



143350 521

CONCEVEZ VOTRE SYSTÈME DE RAILS TRACK 230V

Un éclairage bien conçu est indispensable, surtout là où il y a beaucoup à voir. La grande flexibilité du système de rails permet d'illuminer à la perfection des objets précis. Il est également possible de modifier la configuration à tout moment. Les rails 230V 3 allumages sont parfaits pour les boutiques et stands d'exposition. Combinés aux luminaires SLV compatibles, ils permettent de créer une ambiance harmonieuse et de mettre en valeur les produits et objets exposés. Les rails 230V 1 allumage sont particulièrement adaptés aux résidences privées où baignent les pièces de vie avec une lumière chaleureuse. Les rails préperçés en aluminium s'installent rapidement et facilement au plafond ou au mur. Vous avez le choix entre une version encastrée ou en saillie, disponible en plusieurs coloris.

SÉLECTIONNEZ LES OPTIONS DE VOTRE CHOIX :

- 1 Rail (S-TRACK, EUTRAC, système 1 allumage)
- 2 Type de montage (encastré ou en saillie)
- 3 Luminaire
- 4 Configuration



LE TOUR EST JOUÉ !

SYSTÈMES DE RAILS

S-TRACK
Système 3 allumages



EUTRAC
Système 3 allumages

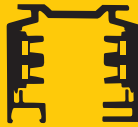

SYSTÈME 1 ALLUMAGE



Rail encastré



Rail en saillie



Plafond



Mur



Suspension

Possibilités de fixation

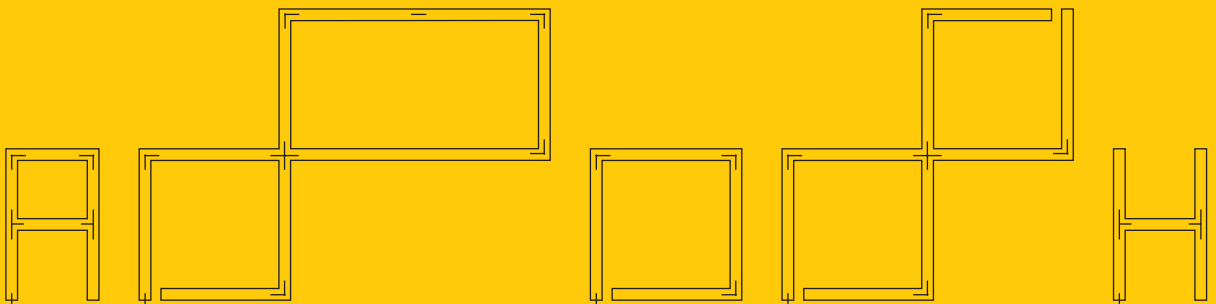

Différentes possibilités de configuration parfaitement ajustées à votre espace

Utilisez également notre configurateur Track sur [slv.com](https://www.slv.com)



1006159 552



Retrouvez les **NUMINOS®** dans les pages familles 110-115

LED



Retrouvez les **ONE®** dans les pages familles 194-195

LED



NEW

TS V | 543



NEW

TS V | 543



NEW

LED

NOBLO® SPOT | 545



NEW

LED

NOBLO® SPOT | 545



NEW

LED

NOBLO® SPOT | 547



NEW

LED

NOBLO® SPOT | 547



NEW

SCKET

PANTILO ROPE 19 | 549



LED

SIGHT TRACK | 550



LED

SIGHT TRACK | 550



LED

SIGHT MOVE | 551



LED

SIGHT MOVE | 551



SCKET

PARA CONE GL | 552



SCKET

PARA CONE GL | 552



SCKET

PARA CONE 14 | 553



SCKET

PARA CONE 14 | 553



SCKET

FORCHINI M 40 TRACK | 554



LED

EURO CUBE | 555



SCKET

EURO SPOT TRACK | 555



SCKET

EURO SPOT TRACK | 555



SCKET

ALTRA DICE TRACK | 556



SCKET

PURI TRACK | 557



SCKET

PURI TRACK GLASS | 557



LED

KALU TRACK LED | 558



SCKET

KALU TRACK | 558



SCKET

BIMA | 559



SCKET

BIMA | 559



LED

HELIA 50 TRACK | 561



LED

ENOLA C TRACK | 561





SCKET

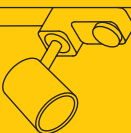

AVO TRACK | 561

COMPATIBILITÉ DES RAILS CONDUCTEURS 3 ALLUMAGES

Compatibles avec les luminaires/adaptateurs de marque :

	SLV	Global/Nordic	EUTRAC®
Rails et composants SLV S-Track DALI			
sans DALI	✓	✓	★
avec DALI	✓	✓	✗

Compatibles avec les rails et composants de marque :

	SLV S-TRACK	Global/Nordic	EUTRAC®
Luminaires SLV S-Track DALI			
sans DALI	✓	✓	✓
avec DALI	✓	✓	✓★★★

★ Sous réserve d'un examen préalable à l'aide d'échantillons du rail et du luminaire
★★★ Mais sans fonctionnalité DALI

Les systèmes de rails et composants SLV présentent un haut niveau de compatibilité avec les luminaires et adaptateurs des marques : EUTRAC®, Zumtobel, Erco, LTS ONETrack et unipro®. Sous réserve d'un examen préalable à l'aide d'échantillons des rails et des luminaires.

Zumtobel	Erco	LTS ONETrack	unipro®
			
✓	✓	✓	✓
✗	✗	✓	✓
Zumtobel	Erco	LTS ONETrack	unipro®
			
✓	✓	✓	✓
✗	✗	✓	✓

Informations fournies sans garantie.

Les données techniques et dimensions peuvent être modifiées à tout moment sans préavis.

Dès l'étape de planification du projet, vérifier la capacité de fonctionnement à l'aide d'un échantillon.

La compatibilité s'applique uniquement aux rails/luminaires.

Ne pas combiner des rails et composants de différents fabricants.





S-TRACK

Rail 3 allumages en saillie DALI

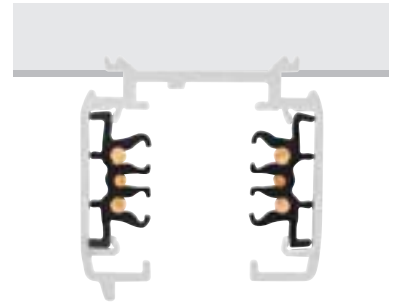

	1 m	1 m	2 m	2 m
Tension nominale (V)	220-240V ~50/60Hz	220-240V ~50/60Hz	220-250V ~50/60Hz	220-250V ~50/60Hz
Intensité max. (A)	16	16	16	16
Charge mécanique max.	30 kg	30 kg	30 kg	30 kg
Coloris	● noir	○ blanc	● noir	○ blanc
Matière	aluminium	aluminium	aluminium	aluminium
L x l x H (cm)	100 x 3,6 x 3,6	100 x 3,6 x 3,6	200 x 3,6 x 3,6	200 x 3,6 x 3,6
Ref.	1004937	1004938	1002631	1002632
CHF	49.10	49.10	99.00	99.00

	3 m	3 m	4 m	4 m
Tension nominale (V)	220-250V ~50/60Hz	220-250V ~50/60Hz	220-250V ~50/60Hz	220-250V ~50/60Hz
Intensité max. (A)	16	16	16	16
Charge mécanique max.	30 kg	30 kg	30 kg	30 kg
Coloris	● noir	○ blanc	● noir	○ blanc
Matière	aluminium	aluminium	aluminium	aluminium
L x l x H (cm)	300 x 3,6 x 3,6	300 x 3,6 x 3,6	400 x 3,6 x 3,6	400 x 3,6 x 3,6
Ref.	1002633	1002634	1002635	1002636
CHF	149.00	149.00	192.00	192.00

S-TRACK

Rail 3 allumages en saillie DALI

Outil de configuration et accessoires en un seul coup d'œil

Pièces vues de dessus
côté montage

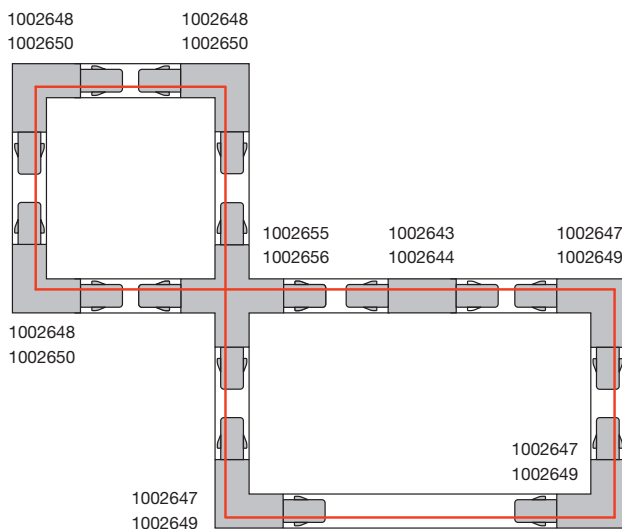
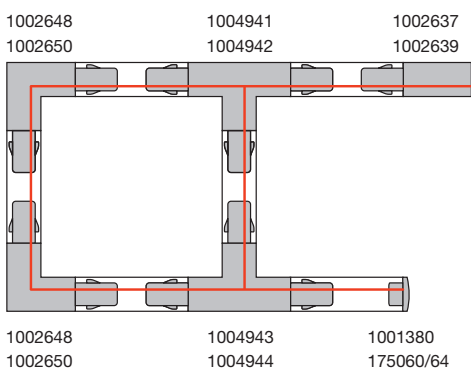
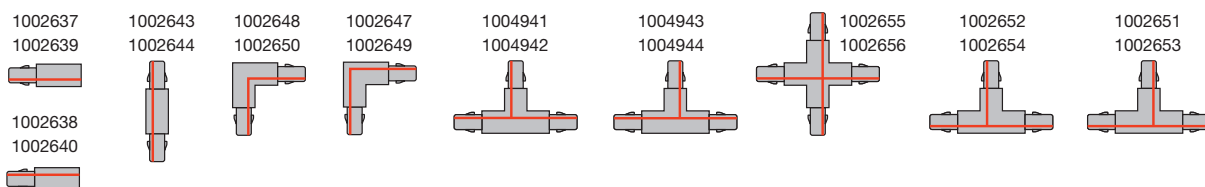
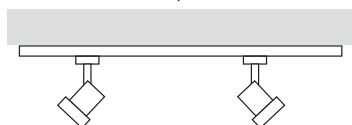

Alimentation, DALI, terre à gauche
16A max. | polycarbonate (PC)
L : 13,9 cm | l : 3,5 cm | H : 3,3 cm

● noir Ref. 1002637 24.50 CHF
○ blanc Ref. 1002639 24.50 CHF



Connecteur en L, DALI, terre extérieure*
16A max. | polycarbonate (PC)
L : 11,9 cm | l : 11,9 cm | H : 3,3 cm

● noir Ref. 1002647 41.60 CHF
○ blanc Ref. 1002649 41.60 CHF



Alimentation, DALI, terre à droite
16A max. | polycarbonate (PC)
L : 13,9 cm | l : 3,5 cm | H : 3,3 cm

● noir Ref. 1002638 24.50 CHF
○ blanc Ref. 1002640 24.50 CHF



Connecteur en L, DALI, terre intérieure*
16A max. | polycarbonate (PC)
L : 11,9 cm | l : 11,9 cm | H : 3,3 cm

● noir Ref. 1002648 41.60 CHF
○ blanc Ref. 1002650 41.60 CHF



Connecteur en T, DALI, terre extérieure, à gauche*
 16A max. | polycarbonate (PC)
 L : 20,3 cm | l : 11,9 cm | H : 3,3 cm

● noir	Ref.	1002652	49.10 CHF
○ blanc		1002654	49.10 CHF

Adaptateur 3 allumages, DALI
 10A max. | polycarbonate (PC)
 L : 11,3 cm | l : 5,5 cm | H : 3,3 cm

● noir	Ref.	1002660	24.50 CHF
○ blanc		1002659	24.50 CHF

Connecteur en T, DALI, terre extérieure, droite*
 16A max. | polycarbonate (PC)
 L : 20,3 cm | l : 11,9 cm | H : 3,3 cm

● noir	Ref.	1002651	49.10 CHF
○ blanc		1002653	49.10 CHF

Adaptateur mécanique 3 allumages
 Aluminium / plastique
 L : 6,6 cm | l : 6,6 cm | H : 3,1 cm

● noir	Ref.	175210	20.20 CHF
○ blanc		1001395	20.20 CHF

Connecteur en T, DALI, terre intérieure, gauche*
 16A max. | polycarbonate (PC)
 L : 20,3 cm | l : 11,9 cm | H : 3,3 cm

● noir	Ref.	1004941	49.10 CHF
○ blanc		1004942	49.10 CHF

Cache 2 m
 Polycarbonate (PC)
 L : 200 cm | l : 1,8 cm | H : 0,75 cm

● noir	Ref.	1004939	9.50 CHF
○ blanc		1004940	9.50 CHF

Connecteur en T, DALI, terre intérieure, droite*
 16A max. | polycarbonate (PC)
 L : 20,3 cm | l : 11,9 cm | H : 3,3 cm

● noir	Ref.	1004943	49.10 CHF
○ blanc		1004944	49.10 CHF

Embout
 Plastique
 L : 3,5 cm | l : 3,3 cm | H : 3,2 cm

● noir	Ref.	175060	3.10 CHF
○ blanc		1001380	3.10 CHF

Connecteur en X, DALI*
 16A max. | polycarbonate (PC)
 L : 20,3 cm | l : 20,3 cm | H : 3,3 cm

● noir	Ref.	1002655	82.00 CHF
○ blanc		1002656	82.00 CHF

Suspension rigide
 Aluminium / plastique
 L : 6 cm | l : 6 cm | H : 4 cm
 Charge mécanique max. : 10 kg

● noir	Ref.	175160	41.60 CHF
○ blanc		1001390	41.60 CHF

Connecteur longitudinal, DALI*
 16A max. | polycarbonate (PC)
 L : 20,3 cm | l : 3,5 cm | H : 3,3 cm

● noir	Ref.	1002643	41.60 CHF
○ blanc		1002644	41.60 CHF

Connecteur mécanique
 aluminium
 L : 18,2 cm | l : 3,3 cm | H : 2,1 cm

● noir	Ref.	175180	14.90 CHF
○ blanc		1001392	14.90 CHF

Mini-connecteur, DALI
 16A max. | polycarbonate (PC)
 L : 10,6 cm | l : 2,5 cm | H : 2,8 cm

● noir	Ref.	1002641	13.80 CHF
○ blanc		1002642	13.80 CHF

Adaptateur mécanique 3 allumages avec crochet
 Plastique / acier
 H : 5,2 cm
 Charge mécanique max. : 10 kg

● noir	Ref.	175190	4.10 CHF
○ blanc		1001393	4.10 CHF

Connecteur flexible, DALI
 16A max. | polycarbonate (PC)
 L : 28,5 cm | l : 3,5 cm | H : 3,3 cm

● noir	Ref.	1002645	67.00 CHF
○ blanc		1002646	67.00 CHF

Patère, DALI
 16A max. | polycarbonate (PC)
 H : 3,5 cm Ø : 14,3 cm

● noir	Ref.	1004684	42.65 CHF
○ blanc		1004685	42.65 CHF

Connecteur isolé
 Plastique
 L : 6,8 cm | l : 3,1 cm | H : 2,6 cm

● noir	Ref.	175080	10.60 CHF
○ blanc		1001382	10.60 CHF

Suspension à câbles métalliques (2 pièces)
 Acier inoxydable / laiton
 L : 500 cm
 Charge mécanique max. : 10 kg

● nickel	Ref.	1002845	55.00 CHF
----------	------	----------------	------------------

Clip de suspension, DALI
 Acier
 L : 4 cm | l : 3,4 cm | H : 1,25 cm

● noir	Ref.	1002657	10.60 CHF
○ blanc		1002658	10.60 CHF

* avec possibilité d'alimentation

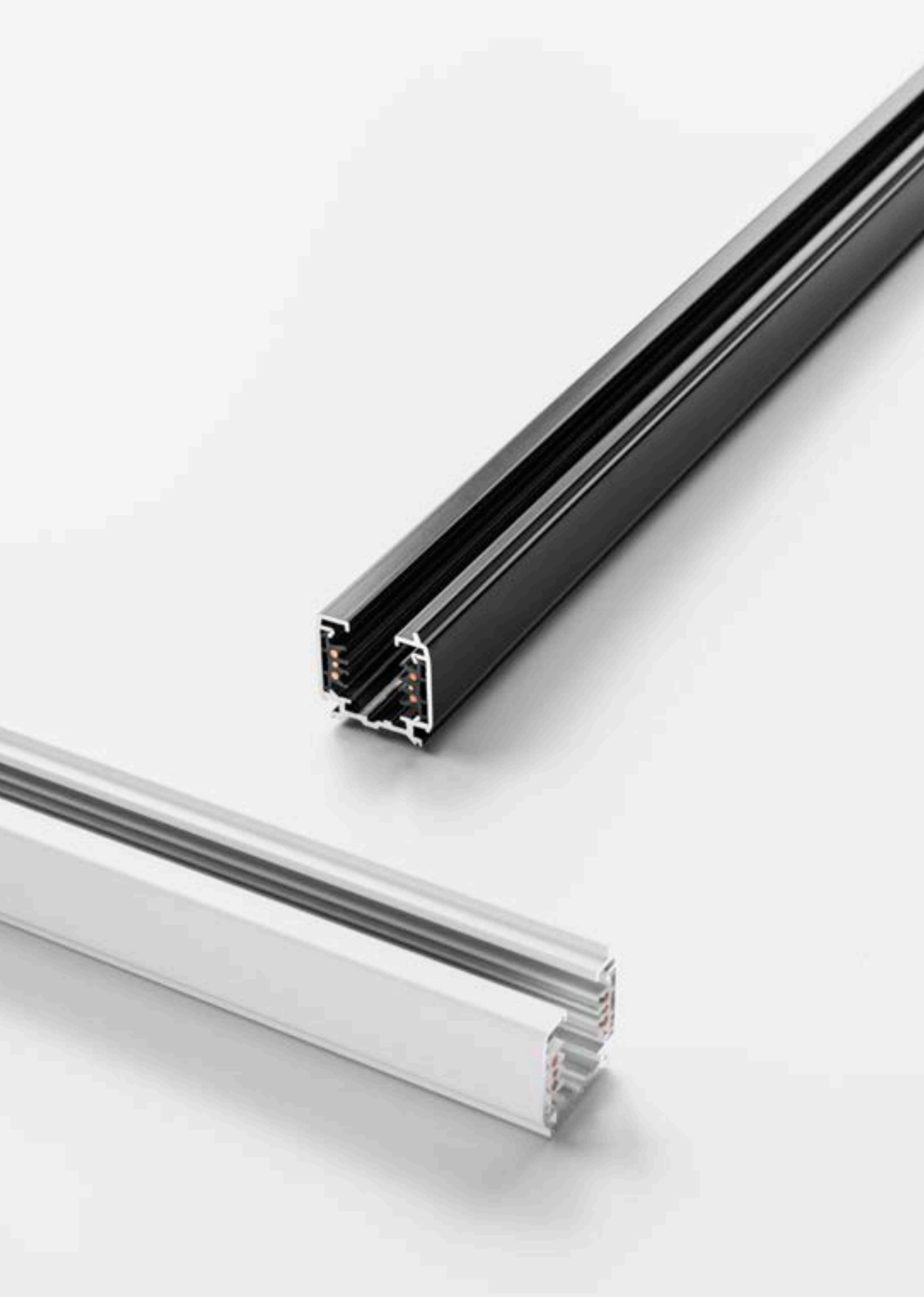



NEW

S-TRACK

Rail 3 allumages encastré DALI

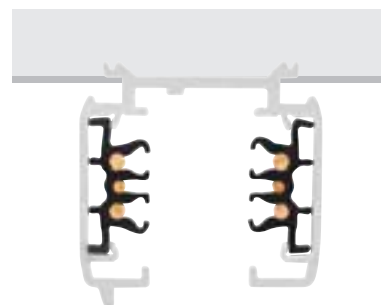

	1 m	1 m	2 m	2 m
Tension nominale (V)	220-250V ~50/60Hz	220-250V ~50/60Hz	220-250V ~50/60Hz	220-250V ~50/60Hz
Intensité max. (A)	16	16	16	16
Charge mécanique max.	30 kg	30 kg	30 kg	30 kg
Coloris	● noir	○ blanc	● noir	○ blanc
Matière	aluminium	aluminium	aluminium	aluminium
L x l x H (cm)	100 x 5,6 x 3,2	100 x 5,6 x 3,2	200 x 5,6 x 3,2	200 x 5,6 x 3,2
Ref.	1006511 ●	1006512 ●	1006513 ●	1006514 ●
CHF	62.90	62.90	115.00	115.00

	3 m	3 m	4 m	4 m
Tension nominale (V)	220-250V ~50/60Hz	220-250V ~50/60Hz	220-250V ~50/60Hz	220-250V ~50/60Hz
Intensité max. (A)	16	16	16	16
Charge mécanique max.	30 kg	30 kg	30 kg	30 kg
Coloris	● noir	○ blanc	● noir	○ blanc
Matière	aluminium	aluminium	aluminium	aluminium
L x l x H (cm)	300 x 5,6 x 3,2	300 x 5,6 x 3,2	400 x 5,6 x 3,2	400 x 5,6 x 3,2
Ref.	1006515 ●	1006516 ●	1006517 ●	1006518 ●
CHF	162.00	162.00	259.00	259.00



S-TRACK

Rail 3 allumages encastré DALI

Outil de configuration et accessoires en un seul coup d'œil

Pièces vues de dessus
côté montage

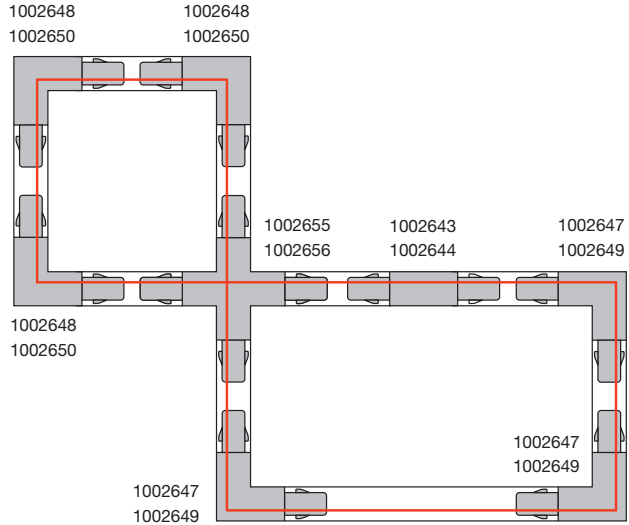
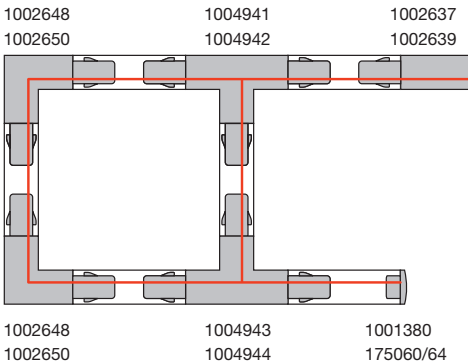
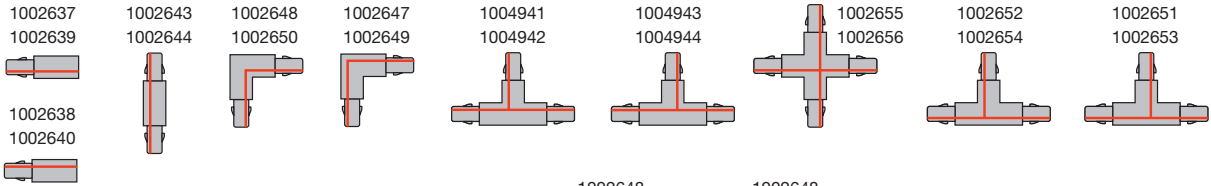
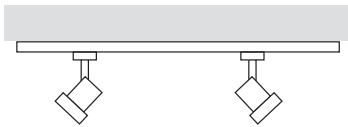



Alimentation, DALI, terre à droite
16A max. | polycarbonate (PC)
L : 14,7 cm | l : 5,6 cm | H : 3,3 cm

- noir Ref. 1006519 22.90 CHF
- blanc Ref. 1006520 22.90 CHF



Connecteur en T, DALI, terre extérieure, droite*
16A max. | polycarbonate (PC)
L : 20,3 cm | l : 13 cm | H : 3,3 cm

- noir Ref. 1006533 45.90 CHF
- blanc Ref. 1006534 45.90 CHF



Alimentation, DALI, terre à gauche
16A max. | polycarbonate (PC)
L : 14,7 cm | l : 5,6 cm | H : 3,3 cm

- noir Ref. 1006521 22.90 CHF
- blanc Ref. 1006522 22.90 CHF



Connecteur en T, DALI, terre intérieure, gauche*
16A max. | polycarbonate (PC)
L : 20,3 cm | l : 13 cm | H : 3,3 cm

- noir Ref. 1006527 45.90 CHF
- blanc Ref. 1006528 45.90 CHF



Connecteur en L, DALI, terre extérieure*
16A max. | polycarbonate (PC)
L : 13 cm | l : 13 cm | H : 3,3 cm

- noir Ref. 1006525 39.90 CHF
- blanc Ref. 1006526 39.90 CHF



Connecteur en X, DALI*
16A max. | polycarbonate (PC)
L : 20,3 cm | l : 20,3 cm | H : 3,3 cm

- noir Ref. 1006535 72.90 CHF
- blanc Ref. 1006536 72.90 CHF



Connecteur en L, DALI, terre intérieure*
16A max. | polycarbonate (PC)
L : 13 cm | l : 13 cm | H : 3,3 cm

- noir Ref. 1006523 39.90 CHF
- blanc Ref. 1006524 39.90 CHF



Connecteur longitudinal, DALI*
16A max. | polycarbonate (PC)
L : 20,3 cm | l : 5,6 cm | H : 3,3 cm

- noir Ref. 1006537 39.90 CHF
- blanc Ref. 1006538 39.90 CHF



Connecteur en T, DALI, terre extérieure, gauche*
16A max. | polycarbonate (PC)
L : 20,3 cm | l : 13 cm | H : 3,3 cm

- noir Ref. 1006529 45.90 CHF
- blanc Ref. 1006530 45.90 CHF



Mini-connecteur, DALI
16A max. | polycarbonate (PC)
L : 10,6 cm | l : 2,5 cm | H : 2,8 cm

- noir Ref. 1002641 13.80 CHF
- blanc Ref. 1002642 13.80 CHF



Connecteur en T, DALI, terre intérieure, droite*
16A max. | polycarbonate (PC)
L : 20,3 cm | l : 13 cm | H : 3,3 cm

- noir Ref. 1006531 45.90 CHF
- blanc Ref. 1006532 45.90 CHF



Embout, DALI
Polycarbonate (PC)
L : 4,79 cm | l : 5,6 cm

- noir Ref. 1006539 4.50 CHF
- blanc Ref. 1006540 4.50 CHF

* avec possibilité d'alimentation





EUTRAC®

Rail 3 allumages en saillie

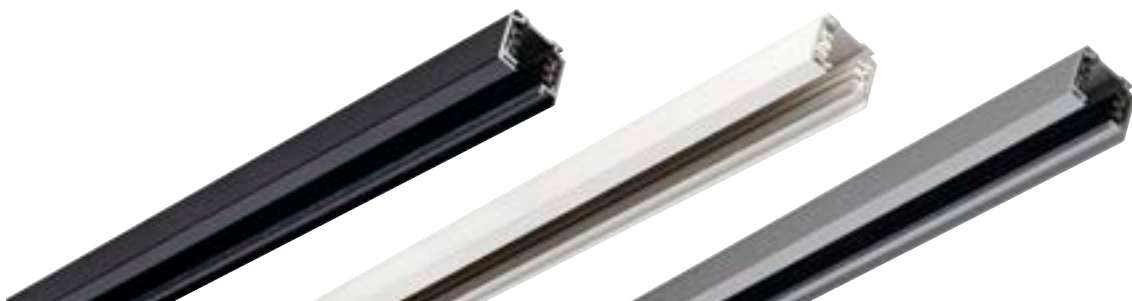
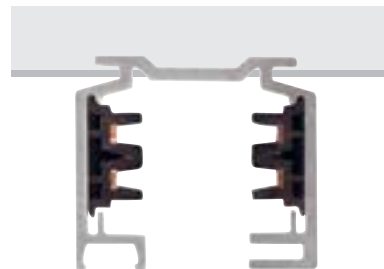

	1 m	1 m	1 m
Tension nominale (V)	220-240V ~50/60Hz	220-240V ~50/60Hz	220-240V ~50/60Hz
Intensité max. (A)	16	16	16
Coloris	● noir	○ blanc	● gris
Matière	Aluminium / plastique	Aluminium / plastique	Aluminium / plastique
L x l x H (cm)	100 x 3,6 x 3,2	100 x 3,6 x 3,2	100 x 3,6 x 3,2
Ref.	145100	1001510	145102
CHF	59.00	59.00	59.00
	2 m	2 m	2 m
Tension nominale (V)	220-240V ~50/60Hz	220-240V ~50/60Hz	220-240V ~50/60Hz
Intensité max. (A)	16	16	16
Coloris	● noir	○ blanc	● gris
Matière	Aluminium / plastique	Aluminium / plastique	Aluminium / plastique
L x l x H (cm)	200 x 3,6 x 3,2	200 x 3,6 x 3,2	200 x 3,6 x 3,2
Ref.	145200	1001511	145202
CHF	113.00	113.00	113.00
	3 m	3 m	3 m
Tension nominale (V)	220-240V ~50/60Hz	220-240V ~50/60Hz	220-240V ~50/60Hz
Intensité max. (A)	16	16	16
Coloris	● noir	○ blanc	● gris
Matière	Aluminium / plastique	Aluminium / plastique	Aluminium / plastique
L x l x H (cm)	300 x 3,6 x 3,2	300 x 3,6 x 3,2	300 x 3,6 x 3,2
Ref.	145300	1001512	145302
CHF	187.00	192.00	187.00

EUTRAC®

Rail 3 allumages en saillie

Outil de configuration et accessoires en un seul coup d'œil

Pièces vues de dessus
côté montage

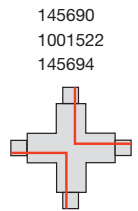
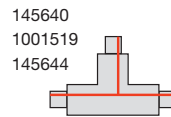
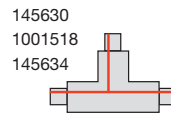
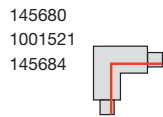
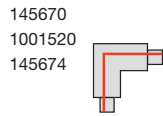
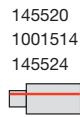
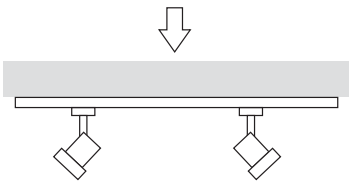

Exemple : terre extérieure

145670
1001520
145674

145510
1001513
145514

145670
1001520
145674

145680
1001521
145684

145520
1001514
145524

Exemple : terre intérieure

145670
1001520
145674

145680
1001521
145684

145690
1001522
145694

145680
1001521
145684

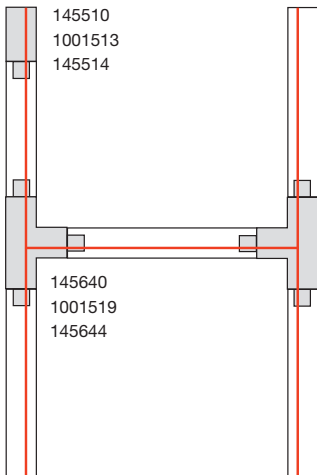

145520
1001514
145524

145680
1001521
145684



Alimentation, terre à gauche
16A max. | plastique
L : 11,2 cm | l : 3,6 cm | H : 3,2 cm

● noir	Ref.	145510	24.50 CHF
○ blanc		1001513	24.50 CHF
● gris		145514	24.50 CHF

Connecteur mécanique
Plastique
L : 10 cm | l : 3,6 cm | H : 1,9 cm

● noir	Ref.	145600	27.70 CHF
○ blanc		1001523	27.70 CHF
● gris		145604	27.70 CHF

Alimentation, terre à droite
16A max. | plastique
L : 11,2 cm | l : 3,6 cm | H : 3,2 cm

● noir	Ref.	145520	24.50 CHF
○ blanc		1001514	24.50 CHF
● gris		145524	24.50 CHF

Connecteur flexible
16A max. | plastique
L : 30,7 cm | l : 3,6 cm | H : 3,2 cm

● noir	Ref.	145580	109.00 CHF
○ blanc		1001524	109.00 CHF
● gris		145584	109.00 CHF

Alimentation centrale
16A max. | plastique
L : 13 cm | l : 3,6 cm | H : 3,6 cm

● noir	Ref.	145530	55.00 CHF
○ blanc		1001515	55.00 CHF
● gris		145534	55.00 CHF

Prise
6,3A max. | plastique
L : 9,6 cm | l : 6,5 cm | H : 9 cm

● noir	Ref.	145700	117.00 CHF
○ blanc		1001525	117.00 CHF

Connecteur longitudinal*
16A max. | plastique
L : 19,2 cm | l : 3,6 cm | H : 3,2 cm

● noir	Ref.	145660	96.00 CHF
○ blanc		1001517	96.00 CHF
● gris		145664	96.00 CHF

Adaptateur 3 allumages
10A max. | plastique
L : 9,6 cm | l : 3,5 cm | H : 4,5 cm
Charge mécanique max. : 5 kg

● noir	Ref.	145990	24.50 CHF
○ blanc		1001542	24.50 CHF
● gris		145994	24.50 CHF

Connecteur longitudinal*
16A max. | plastique
L : 5,8 cm | l : 1,5 cm | H : 2,6 cm

● noir	Ref.	145560	24.50 CHF
○ blanc		1001516	24.50 CHF
● gris		145564	24.50 CHF

Clip de suspension
aluminium
L : 5 cm | l : 3,6 cm | H : 1,9 cm

● noir	Ref.	145730	14.90 CHF
○ blanc		1001530	14.90 CHF
● gris		145734	14.90 CHF

Connecteur en L, terre intérieure*
16A max. | plastique
L : 15 cm | l : 15 cm | H : 3,2 cm

● noir	Ref.	145680	78.00 CHF
○ blanc		1001521	79.00 CHF
● gris		145684	79.00 CHF

Patère universelle
16A max. | plastique
H : 3,1 cm Ø : 11,9 cm

● noir	Ref.	145830	124.00 CHF
○ blanc		1001526	134.00 CHF
● gris		145834	156.00 CHF

Connecteur en L, terre extérieure*
16A max. | plastique
L : 15 cm | l : 15 cm | H : 3,2 cm

● noir	Ref.	145670	78.00 CHF
○ blanc		1001520	79.00 CHF
● gris		145674	79.00 CHF

Embout
Plastique
L : 3,6 cm | l : 1,7 cm | H : 3,2 cm

● noir	Ref.	145590	5.25 CHF
○ blanc		1001527	5.25 CHF
● gris		145594	5.25 CHF

Connecteur en T, terre intérieure, à gauche*
16A max. | plastique
L : 26 cm | l : 18,5 cm | H : 3,2 cm

● noir	Ref.	145630	117.00 CHF
○ blanc		1001518	117.00 CHF
● gris		145634	117.00 CHF

Suspension rigide
Plastique / acier
L : 60 cm | H : 63,5 cm Ø : 7 cm

● noir	Ref.	145720	49.10 CHF
○ blanc		1001529	49.10 CHF
● gris		145724	49.10 CHF

Connecteur en T, terre intérieure, à droite*
16A max. | plastique
L : 26 cm | l : 18,5 cm | H : 3,2 cm

● noir	Ref.	145640	117.00 CHF
○ blanc		1001519	117.00 CHF
● gris		145644	117.00 CHF

Suspension rigide
Plastique / acier
H : 122 cm Ø : 7 cm

● noir	Ref.	145710	55.00 CHF
○ blanc		1001528	55.00 CHF
● gris		145714	55.00 CHF

Connecteur en X*
16A max. | plastique
L : 26 cm | l : 26 cm | H : 3,2 cm

● noir	Ref.	145690	156.00 CHF
○ blanc		1001522	156.00 CHF
● gris		145694	156.00 CHF

Suspension à câbles métalliques (lot de 2 pièces)
Acier inoxydable / laiton
L : 500 cm
Charge mécanique max. : 10 kg

● nickel	Ref.	1002845	55.00 CHF
----------	------	---------	-----------

* avec possibilité d'alimentation





EUTRAC®

Rail 3 allumages encastré avec accessoires compatibles

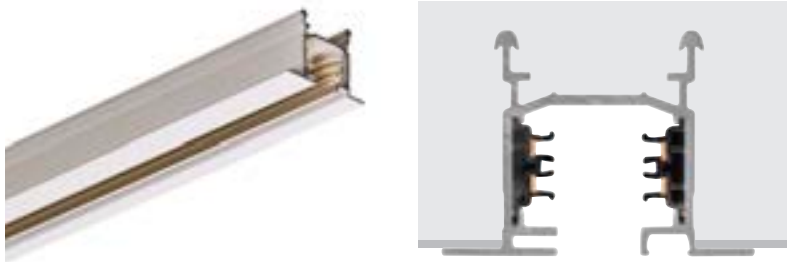

	2 m	3 m
Tension nominale (V)	220-240V ~50/60Hz	220-240V ~50/60Hz
Intensité max. (A)	16	16
Coloris	○ blanc	○ blanc
Matière	Aluminium / plastique	Aluminium / plastique
L x l x H (cm)	200 x 5,9 x 4,1	300 x 5,9 x 4,1
Ref.	1001531	1001532
CHF	156.00	239.00

 <p>Alimentation, terre à gauche 16A max. plastique / acier L : 12,2 cm l : 6 cm H : 3,4 cm</p> <p>○ blanc Ref. 1001533 41.60 CHF</p>	 <p>Embout Plastique L : 2,7 cm l : 6 cm H : 3,2 cm</p> <p>○ blanc Ref. 1001538 10.60 CHF</p>
 <p>Alimentation, terre à droite 16A max. plastique / acier L : 12,2 cm l : 6 cm H : 3,4 cm</p> <p>○ blanc Ref. 1001534 41.60 CHF</p>	 <p>Connecteur longitudinal avec stabilisateur 16A max. plastique / acier L : 6,2 cm l : 2,5 cm H : 2,7 cm</p> <p>○ blanc Ref. 1001539 33.00 CHF</p>
 <p>Connecteur en L, terre extérieure, avec possibilité d'alimentation 16A max. plastique / acier L : 16 cm l : 16 cm H : 3,2 cm</p> <p>○ blanc Ref. 1001536 96.00 CHF</p>	 <p>Clip ressort de montage (6 pièces) Acier L : 2 cm l : 1 cm H : 2,5 cm</p> <p>● gris Ref. 145551 17.00 CHF</p>
 <p>Connecteur en L, terre intérieure, avec possibilité d'alimentation 16A max. plastique / acier L : 16 cm l : 16 cm H : 3,2 cm</p> <p>○ blanc Ref. 1001537 96.00 CHF</p>	 <p>Adaptateur 3 allumages Plastique L : 9,6 cm l : 3,5 cm H : 4,5 cm Charge mécanique max. : 5 kg</p> <p>○ blanc Ref. 1001542 24.50 CHF</p>

1007655 543





TS V
3 all.

TS V
3 all.

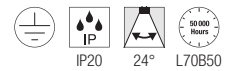
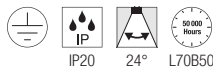
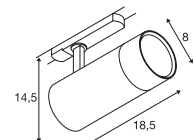
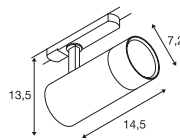

220-240V ~50/60Hz | 250/350/500mA
Puissance totale : 20W
Matière : aluminium / polycarbonate (PC)

220-240V ~50/60Hz | 600/750mA
Puissance totale : 35W
Matière : aluminium / polycarbonate (PC)



Down	1800lm	2700K
	1980lm	3000K
	1920lm	4000K

Down	3090lm	2700K
	3470lm	3000K
	3300lm	4000K

Coloris	Ref.	CHF
● noir	1007655	182.90
○ blanc	1007654	182.90

Coloris	Ref.	CHF
● noir	1007657	205.90
○ blanc	1007656	205.90

1007646 545





NOBLO® SPOT
3 all., PHASE



NOBLO® SPOT
3 all., PHASE

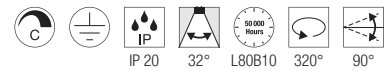
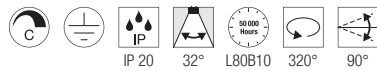
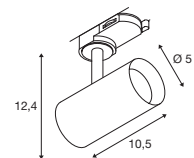
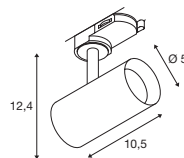

220-240V ~50/60Hz | 150mA
Puissance totale : 6,2W
Matière : aluminium / polycarbonate (PC)

220-240V ~50/60Hz | 150mA
Puissance totale : 6,2W
Matière : aluminium / polycarbonate (PC)



Down 740lm | 2700K



Down 750lm | 3000K

Coloris	Ref.	CHF
● noir	1007644	86.30
○ blanc	1007645	86.30

Coloris	Ref.	CHF
● noir	1007646	86.30
○ blanc	1007647	86.30

1007649 547





NOBLO® SPOT 3 all., PHASE



NOBLO® SPOT 3 all., PHASE

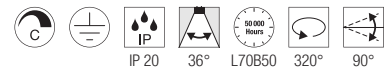
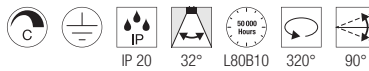
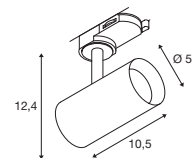
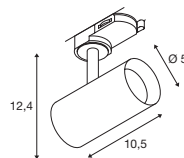

220-240V ~50/60Hz | 150mA
Puissance totale : 6,2W
Matière : aluminium / polycarbonate (PC)

220-240V ~50/60Hz | 350mA
Puissance totale : 8,4W
Matière : aluminium / polycarbonate (PC)



Down 760lm | 4000K



Down 30lm | 2000K - 450lm | 3000K

Coloris	Ref.	CHF
● noir	1007648	86.30
○ blanc	1007649	86.30

Coloris	Ref.	CHF
● noir	1007355	103.50
○ blanc	1007356	103.50

1007597 549

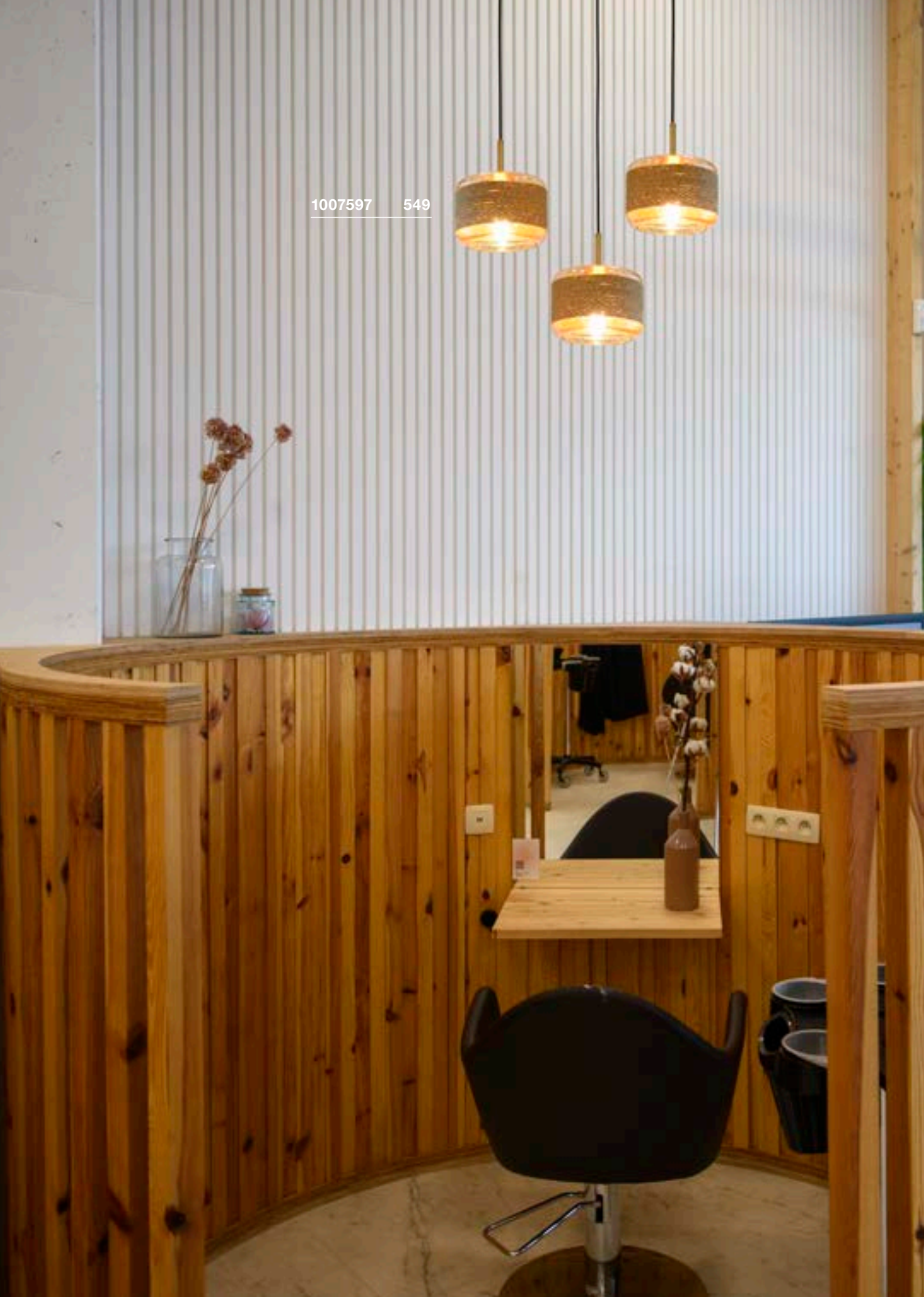



PANTILO ROPE 19 PD, E27

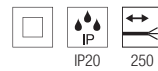
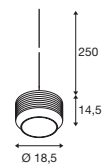

200-240V ~50/60Hz
Matière : verre / acier / chanvre

- Câble nu

**SECRET
INSIDE** <15
W

Douille : 1xE27 Ø max. : 10 cm L : 11 cm

Coloris	Ref.	CHF
● ambre / or	1007597	● 228.90
● anthracite / argent	1007596	● 228.90



A60 | 7,5W | 180°
2700K | 720lm | CEE=F
8kWh / 1000h



Ref. : **1005305** | **24.50 CHF**



SIGHT TRACK
3 all., DALI

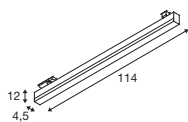

220-240V ~50/60Hz | 700mA
Puissance totale : 39W
Matière : aluminium / acrylique



Down 3000lm | 3000K | 3000lm | 4000K

Coloris	Ref.	CHF
● noir	1005397	469.00
○ blanc	1005399	469.00

SIGHT TRACK
3 all.

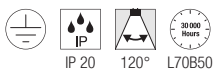
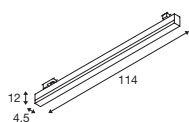

220-240V ~50/60Hz | 700mA
Puissance totale : 37W
Matière : aluminium / acrylique



Down 3000lm | 3000K | 3000lm | 4000K

Coloris	Ref.	CHF
● noir	1005400	390.00
○ blanc	1005401	390.00
● gris	1005402	390.00

1005400 550





1005399 551

SIGHT MOVE 3 all., DALI

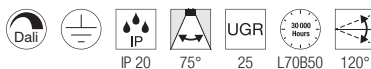
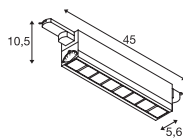

220-240V ~50/60Hz | 350mA
Puissance totale : 26W
Matière : aluminium /
polyméthacrylate de méthyle (PMMA)



Down 2700lm | 3000K
3100lm | 4000K

Coloris	Ref.	CHF
● noir 2700lm 3000 K	1004690	319.00
○ blanc 2700lm 3000 K	1004691	319.00
● noir 3100lm 4000 K	1004692	319.00
○ blanc 3100lm 4000 K	1004693	319.00

SIGHT MOVE 3 all.

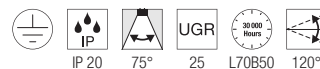
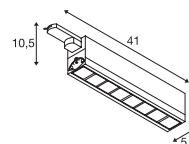

220-240V ~50/60Hz | 350mA
Puissance totale : 26W
Matière : aluminium /
polyméthacrylate de méthyle (PMMA)



Down 2700lm | 3000K
3100lm | 4000K

Coloris	Ref.	CHF
● noir 2700lm 3000 K	1004686	209.00
○ blanc 2700lm 3000 K	1004687	209.00
● noir 3100lm 4000 K	1004688	209.00
○ blanc 3100lm 4000 K	1004689	209.00

PARA CONE GL
3 all., GU10

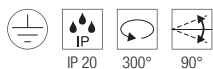
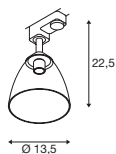

220-240V ~50/60Hz
Matière : aluminium / verre



Douille : 1xGU10

Coloris	Ref.	CHF
● noir	1006157	132.00
○ blanc	1006158	132.00



LED GU10 51mm | 3,2W
2700K | 270lm | CEE=G



Ref. : 1006321 | 55.20 CHF

PARA CONE GL
PD, GU10

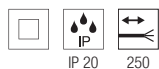
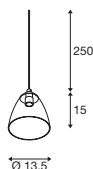

220-240V ~50/60Hz
Matière : aluminium / verre

- Câble nu



Douille : 1xGU10

Coloris	Ref.	CHF
● noir	1006159	109.00
○ blanc	1006160	109.00



LED GU10 51mm | 3,2W
2700K | 270lm | CEE=G



Ref. : 1006321 | 55.20 CHF

1006157 552

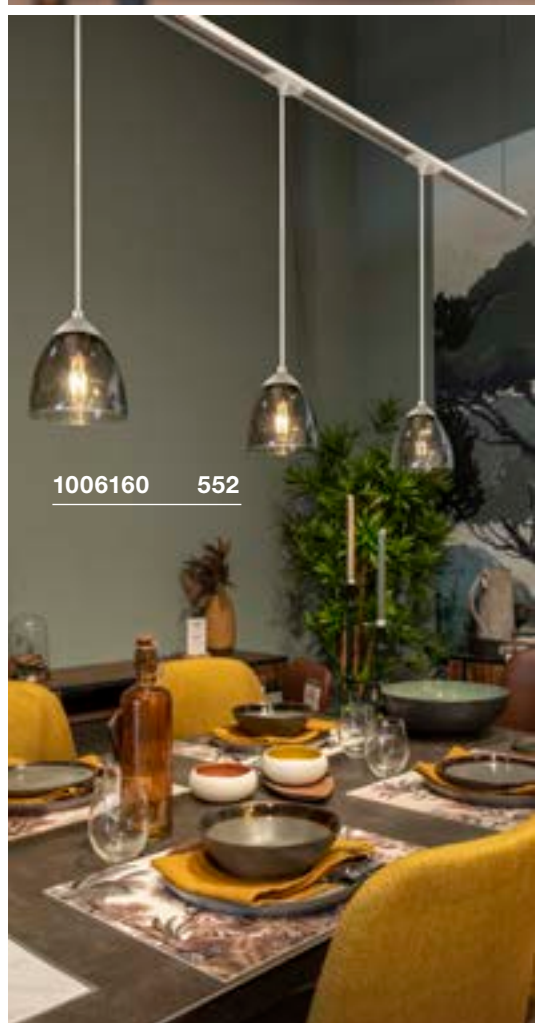

1006160 552



PARA CONE 14
3 all., QPAR51

PARA CONE 14
3 all., PD, QPAR51

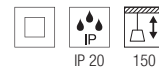
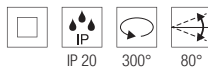
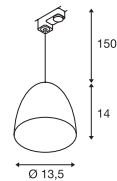
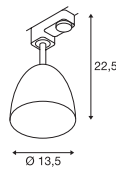

220-240V ~50/60Hz
Matière : acier

220-240V ~50/60Hz
Matière : aluminium

- Version noir / or avec réflecteur doré
- Toutes les autres versions présentent le réflecteur blanc



Douille : 1xGU10

Douille : 1xGU10

Coloris	Ref.	CHF
● noir	1002876	109.00
○ blanc	1002877	109.00
● cuivre	1002878	117.00

Coloris	Ref.	CHF
● noir	153140	138.00
○ blanc	153141	138.00
● cuivre	1002686	156.00



LED GU10 51mm | 3,2W
2700K | 270lm | CEE=G



Ref. : 1006321 | 55.20 CHF



LED GU10 51mm | 3,2 W
2700K | 270lm | CEE=G



Ref. : 1006321 | 55.20 CHF

153141 553

FORCHINI M 40 TRACK
3 all., PD, E27

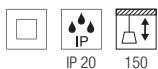
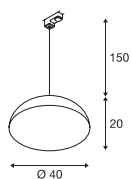

220-240V ~50/60Hz
Matière : aluminium / acier



Douille : 1xE27 Ø max. : 6,8 cm L : 15,2 cm

Coloris	Ref.	CHF
● noir / or	153130	259.00



A60 | 7,5W | 180°
2700K | 720lm | CEE=F
8kWh / 1000h



Ref. : 1005305 | 24.50 CHF

153130 554



152750 555





EURO CUBE
3 all.

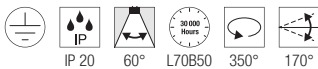
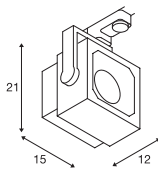

220-240V ~50/60Hz
Puissance totale : 26W
Matière : aluminium



Down 2470lm | 3000K
2740lm | 4000K

Coloris	Ref.	CHF
● noir		
2470lm 3000K	152750	319.00
○ blanc		
2470lm 3000K	152751	319.00
● noir		
2740lm 4000K	152780	319.00
○ blanc		
2740lm 4000K	152781	319.00

EURO SPOT TRACK
3 all., QPAR111

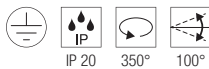
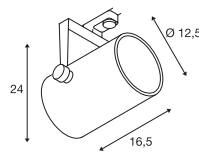

220-240V ~50/60Hz
Matière : aluminium



Douille : 1xGU10

Coloris	Ref.	CHF
● noir	153420	124.00
○ blanc	153421	124.00



QPAR111 | 12,5W | 30°
2700K | 950lm | CEE=F
13kWh / 1000h



Ref. : **1005276** | **62.00 CHF**

EURO SPOT TRACK
3 all., QPAR51

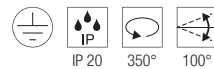
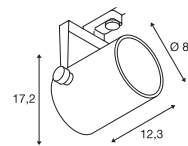

220-240V ~50/60Hz
Matière : aluminium



Douille : 1xGU10

Coloris	Ref.	CHF
● noir	153850	106.00
○ blanc	153851	106.00



LED GU10 51mm | 6W | 38°
2700K | 450lm | CEE=F
6kWh / 1000h



Ref. : **1005077** | **10.60 CHF**

ALTRA DICE TRACK
3 all., QPAR51

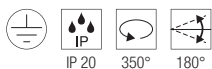
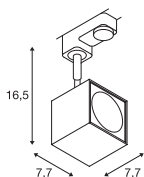

220-240V ~50/60Hz
Matière : aluminium



Douille : 1xGU10 | Ø max. : 5,1 cm | L : 5,7 cm

Coloris	Ref.	CHF
● noir	152320	125.00
○ blanc	152321	125.00



LED GU10 51mm | 6W | 36°
2200-2700K | 360lm | CEE=G
6kWh / 1000h



Ref. : 1005273 | 12.90 CHF

152320 556





PURI TRACK
3 all., QPAR51

PURI TRACK GLASS
3 all., QPAR51

153560 557

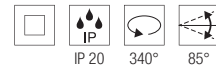
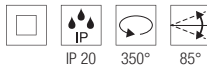
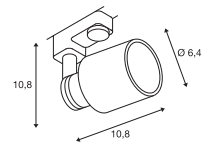
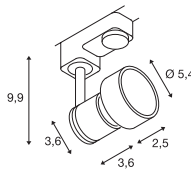

220-240V ~50/60Hz
Matière : aluminium / polycarbonate (PC)

220-240V ~50/60Hz
Matière : aluminium / plastique

- Anneau déco inclus



Douille : 1xGU10

Douille : 1xGU10

Coloris	Ref.	CHF
● noir	153560	48.00
○ blanc	153561	48.00
● gris	153564	48.00

Coloris	Ref.	CHF
● noir	1001871	56.00
○ blanc	1001872	56.00



LED GU10 51mm | 6W | 38°
2700K | 450lm | CEE=F
6kWh / 1000h



Ref. : 1005075 | 10.60 CHF



LED GU10 51mm | 6W | 38°
2700K | 450lm | CEE=F
6kWh / 1000h



Ref. : 1005077 | 10.60 CHF

KALU TRACK LED
3 all., PHASE

KALU TRACK
3 all., QPAR111

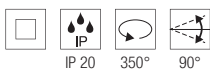
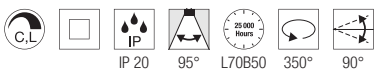
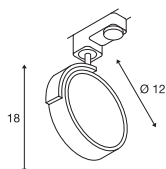
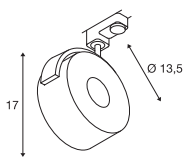

220-240V ~50/60Hz
Puissance totale : 13W
Matière : aluminium

220-240V ~50/60Hz
Matière : aluminium / plastique



Down 970lm | 3000K

Douille : 1xGU10

Coloris	Ref.	CHF
● noir	152600	289.00
○ blanc	152601	289.00

Coloris	Ref.	CHF
● noir	152610	138.00
○ blanc	152611	138.00



QPAR111 | 12,5W | 10°
3000K | 950lm | CEE=F
13kWh / 1000h



Ref. : 1005278 | 65.00 CHF

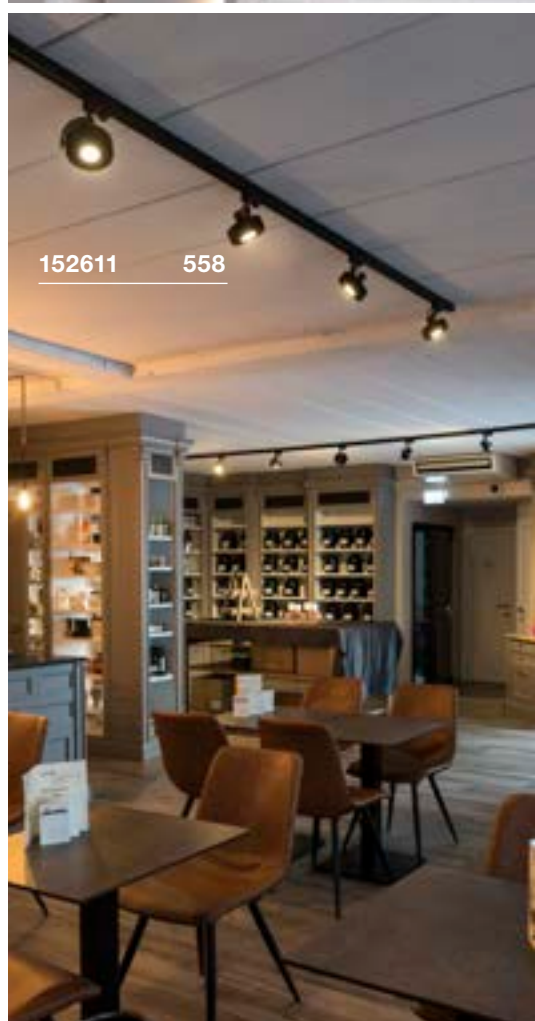



BIMA
3 all., simple, QPAR51

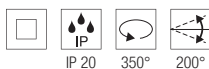
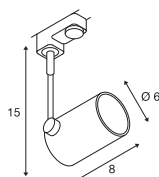

220-240V ~50/60Hz
Matière : aluminium



Douille : 1xGU10 Ø max. : 5,1 cm L : 5,7 cm

Coloris	Ref.	CHF
● noir	152240	85.00
○ blanc	152241	85.00
● gris	152242	85.00



LED GU10 51mm | 6W | 38°
2700K | 450lm | CEE=F
6kWh / 1000h



Ref. : 1005077 | 10.60 CHF



BIMA
3 all., double, QPAR51

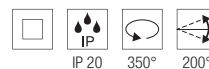
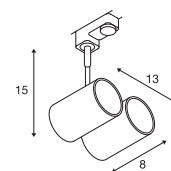

220-240V ~50/60Hz
Matière : aluminium



Douilles : 2xGU10 Ø max. : 5,1 cm L : 5,7 cm

Coloris	Ref.	CHF
● noir	152230	117.00
○ blanc	152231	117.00
● gris	152232	117.00



LED GU10 51mm | 6W | 38°
2700K | 450lm | CEE=F
6kWh / 1000h



Ref. : 1005075 | 10.60 CHF

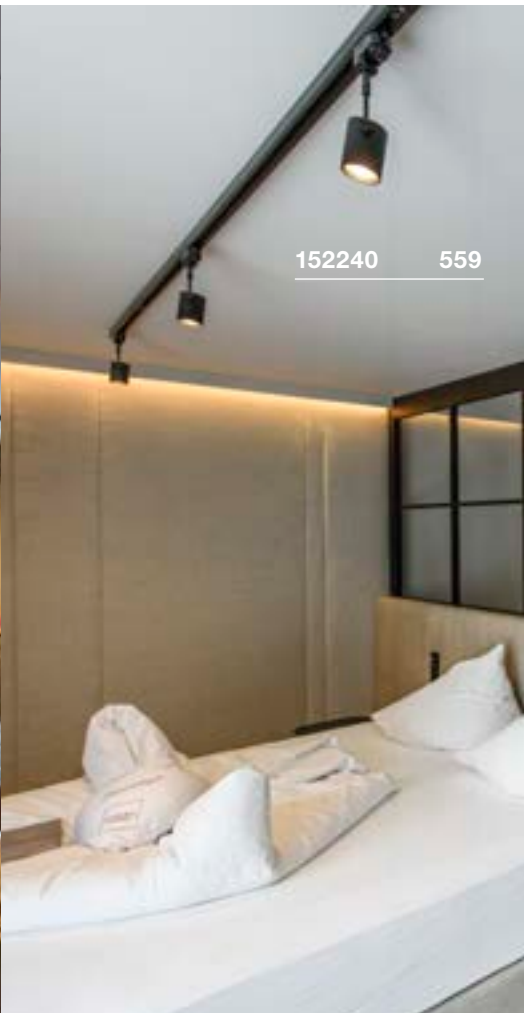



152960 561



152430 561



HELIA 50 TRACK 3 all.

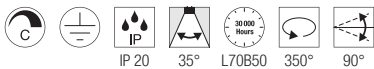
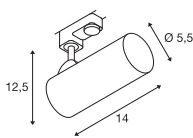

220-240V ~50/60Hz | 500mA
Puissance totale : 11W
Matière : aluminium



Down 810lm | 880lm | 3000K

Coloris	Ref.	CHF
● noir		
810 lm	152960	152.00
○ blanc		
880 lm	152961	152.00

ENOLA C TRACK 3 all.

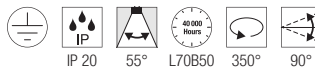
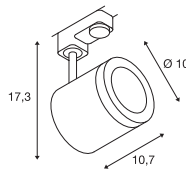

220-240V ~50/60Hz | 500mA
Puissance totale : 11W
Matière : aluminium



Down 1040lm | 3000K

Coloris	Ref.	CHF
● noir	152430	229.00
○ blanc	152431	229.00

AVO TRACK 3 all., QPAR51

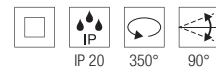
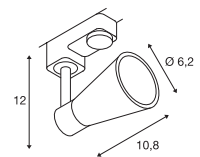

220-240V ~50/60Hz
Matière : acier



Douille : 1xGU10 Ø max. : 5,1 cm

Coloris	Ref.	CHF
● noir	152640	56.00
○ blanc	152641	56.00



LED GU10 51mm | 6W | 38°
2700K | 450lm | CEE=F
6kWh / 1000h



Ref. : **1005077** | **10.60 CHF**

CONCEVEZ VOTRE SYSTÈME DE RAILS TRACK 230V

Un éclairage bien conçu est indispensable, surtout là où il y a beaucoup à voir. La grande flexibilité du système de rails permet d'illuminer à la perfection des objets précis. Il est également possible de modifier la configuration à tout moment. Les rails 230V 3 allumages sont parfaits pour les boutiques et stands d'exposition. Combinés aux luminaires SLV compatibles, ils permettent de créer une ambiance harmonieuse et de mettre en valeur les produits et objets exposés. Les rails 230V 1 allumage sont particulièrement adaptés aux résidences privées où baignent les pièces de vie avec une lumière chaleureuse. Les rails préperçés en aluminium s'installent rapidement et facilement au plafond ou au mur. Vous avez le choix entre une version encastrée ou en saillie, disponible en plusieurs coloris.

SÉLECTIONNEZ LES OPTIONS DE VOTRE CHOIX :

- 1 Rail (S-TRACK, EUTRAC, système 1 allumage)
- 2 Type de montage (encastré ou en saillie)
- 3 Luminaire
- 4 Configuration



LE TOUR EST JOUÉ !

SYSTÈMES DE RAILS

S-TRACK

Système 3 allumages



EUTRAC

Système 3 allumages

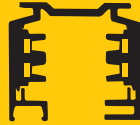

SYSTÈME 1 ALLUMAGE



Rail encastré



Rail en saillie



Plafond



Mur



Suspension

Possibilités de fixation

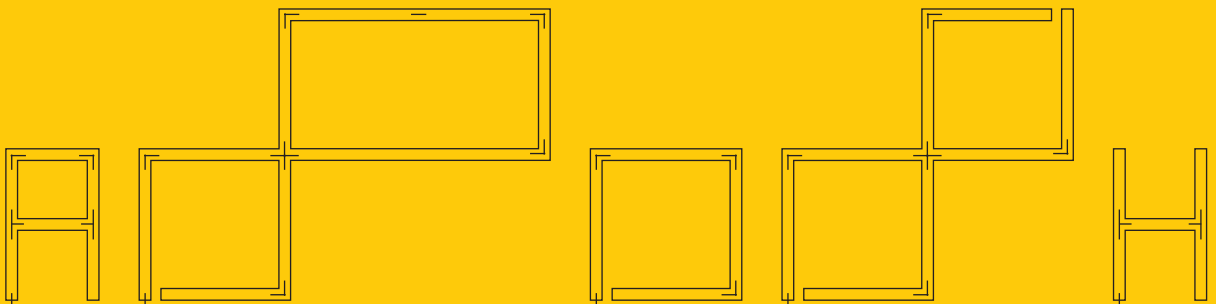

Différentes possibilités de configuration parfaitement ajustées à votre espace

Utilisez également notre configurateur Track sur [slv.com](https://www.slv.com)



PROFILS



GRAZIA 10 PROFIL EN SAILLIE | 567



GRAZIA 10 PROFIL ENCASTRÉ | 567

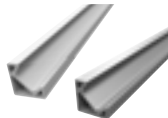

GRAZIA 10 EDGE | 570

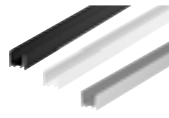

GRAZIA 20 PROFIL EN SAILLIE | 573



GRAZIA 20 PROFIL ENCASTRÉ | 573

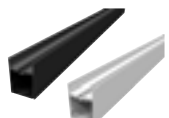

GRAZIA 60 PROFIL EN SAILLIE | 577

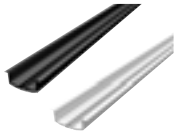

GRAZIA 60 PROFIL ENCASTRÉ | 577



GRAZIA 10 ACCESSOIRES | 569



GRAZIA 10 EDGE ACCESSOIRES | 571



GRAZIA 20 ACCESSOIRES | 574-575



GRAZIA 60 ACCESSOIRES | 578-579

BANDEAUX LED



GRAZIA FLEXSTRIP LED | 582



GRAZIA PRO FLEXSTRIP LED | 583



GRAZIA PRO MAX FLEXSTRIP | 585



GRAZIA PRO FLEXSTRIP TUNABLE WHITE | 587



GRAZIA PRO FLEXSTRIP RGBW | 589



GRAZIA IP FLEXSTRIP | 591



GRAZIA FLEXSTRIP LED ACCESSOIRES | 582



GRAZIA PRO FLEXSTRIP LED ACCESSOIRES | 583



GRAZIA PRO MAX FLEXSTRIP ACCESSOIRES | 585



GRAZIA PRO FLEXSTRIP TUNABLE WHITE ACCESSOIRES | 587



GRAZIA PRO FLEXSTRIP RGBW ACCESSOIRES | 589



GRAZIA 10 Profil en saillie plat 2 m

Matière : aluminium,
Largeur : 1,75 cm, hauteur : 1,1 cm,
Longueur max. du bandeau LED, en mm : 10
Diffuseur en option

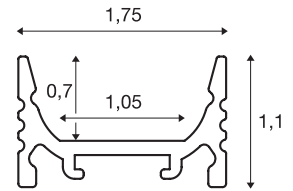

Longueur (cm)	Coloris	Matière	Ref.	CHF
200	● noir	aluminium	1000462	41.60
	○ blanc		1000461	41.60

GRAZIA 10 Profil en saillie standard

Matière : aluminium
Largeur : 1,75 cm, hauteur : 1,62 cm,
Longueur max. du bandeau LED, en mm : 10
Diffuseur en option

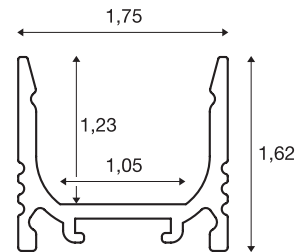

Longueur (cm)	Coloris	Matière	Ref.	CHF
200	● noir	aluminium	1000465	41.60
	○ blanc		1000464	41.60

GRAZIA 10 Profil à encastrer

Matière : aluminium
Largeur : 3 cm, hauteur : 1,62 cm,
Longueur max. du bandeau LED, en mm : 10
Diffuseur en option

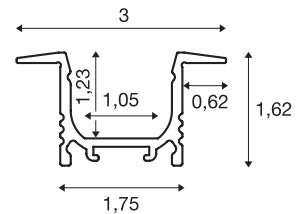
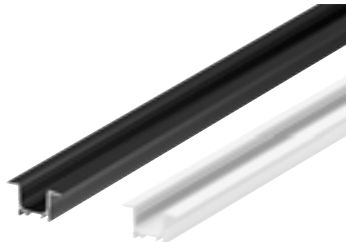

Longueur (cm)	Coloris	Matière	Ref.	CHF
200	● noir	aluminium	1000459	41.60
	○ blanc		1000458	41.60



ACCESSOIRES

GRAZIA 10 Diffuseur



Description	Coloris	Longueur (cm)	Largeur (cm)	Hauteur (cm)	Matière	Ref.	CHF
Diffuseur	<input type="radio"/> dépoli	200	1,58	0,4	Polycarbonate (PC)	1000466	24.50
	<input type="radio"/> opale				Polyméthacrylate de méthyle (PMMA)	1000468	29.85
	<input type="radio"/> satiné					1000469	29.85

GRAZIA 10 Clips de montage



Description	Coloris	Largeur (cm)	Hauteur (cm)	Profondeur (cm)	Matière	Ref.	CHF
Clips de montage	<input type="radio"/> argent, 45°	1,62	1,62	1	Acier	1000489	7.40
	<input type="radio"/> inox, invisible	1,53	0,3	1	Acier inoxydable	1000487	5.25

Vendu par : 2 pièces

GRAZIA 10 Embouts pour profil en saillie

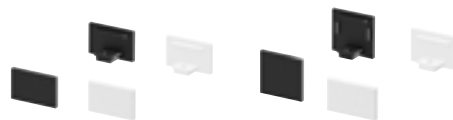

Description	Coloris	Longueur (cm)	Largeur (cm)	Hauteur (cm)	Matière	Ref.	CHF
Embouts	<input checked="" type="radio"/> noir, plat	-	1,75	1,1	aluminium	1000477	9.50
	<input type="radio"/> blanc, plat			1,1		1000476	9.50
Embouts	<input checked="" type="radio"/> noir, standard	-	1,75	1,62	aluminium	1000480	9.90
	<input type="radio"/> blanc, standard			1,62		1000479	9.90

Vendu par : 2 pièces

GRAZIA 10 Embouts pour profil à encastrer



Description	Coloris	Longueur (cm)	Largeur (cm)	Hauteur (cm)	Matière	Ref.	CHF
Embouts	<input checked="" type="radio"/> noir	-	3	1,62	aluminium	1000474	9.50
	<input type="radio"/> blanc					1000473	9.50

Vendu par : 2 pièces



GRAZIA 10 EDGE

2 m

Matière : aluminium
 Largeur : 1,95 cm, hauteur : 1,95 cm,
 Longueur max. du bandeau LED, en mm : 10
 Diffuseur en option



IP 20

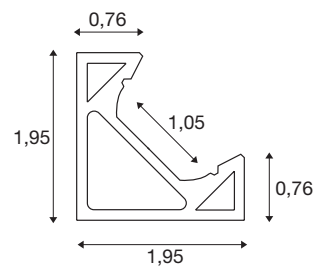
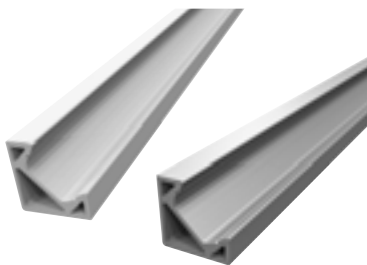

Longueur (cm)	Coloris	Matière	Ref.	CHF
200	<input type="radio"/> blanc	alu brossé	1004890	36.20
	<input checked="" type="radio"/> aluminium		1004889	36.20

ACCESSOIRES

GRAZIA 10 EDGE Diffuseur



Description	Coloris	Longueur (cm)	Largeur (cm)	Hauteur (cm)	Matière	Ref.	CHF
Diffuseur	<input type="radio"/> dépoli	200	1,58	0,4	Polycarbonate (PC)	1000466	24.50
	<input type="radio"/> opale				Polyméthacrylate de méthyle (PMMA)	1000468	29.85
	<input type="radio"/> satiné					1000469	29.85

GRAZIA 10 EDGE Embout



Description	Coloris	Longueur (cm)	Largeur (cm)	Hauteur (cm)	Matière	Ref.	CHF
Embout	<input type="radio"/> blanc	2	0,7	2	Plastique ABS	1004894	4.10
	<input checked="" type="radio"/> alu brossé					1004893	4.10

Vendu par : 2 pièces

GRAZIA 10 EDGE Clips de montage



Description	Coloris	Longueur (cm)	Largeur (cm)	Hauteur (cm)	Matière	Ref.	CHF
Clips de montage	<input checked="" type="radio"/> inox	2,25	15	2,25	Acier	1004895	5.25

Vendu par : 4 pièces



GRAZIA 20

Profil en saillie standard, 3 m

Matière : aluminium
 Largeur : 3,5 cm, hauteur : 3,2 cm,
 Longueur max. du bandeau LED, en mm : 20
 Diffuseur en option

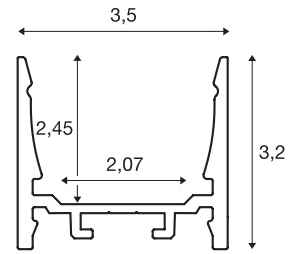
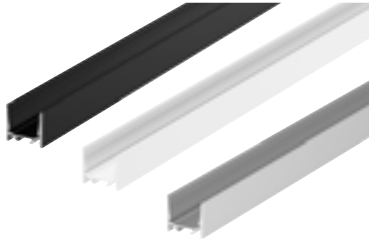

IP 20

Longueur (cm)	Coloris	Matière	Ref.	CHF
300	● noir	aluminium	1000525	122.00
	○ blanc		1000524	122.00
	● alu brossé		1000523	124.00

GRAZIA 20

Profil en saillie plat 3 m

Matière : aluminium
 Largeur : 3,5 cm, hauteur : 2,2 cm,
 Longueur max. du bandeau LED, en mm : 20
 Diffuseur en option

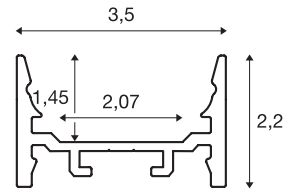

IP 20

Longueur (cm)	Coloris	Matière	Ref.	CHF
300	● noir	aluminium	1000534	96.00
	○ blanc		1000533	96.00

GRAZIA 20

Profil à encastrer 3 m

Matière : aluminium
 Largeur : 5,2 cm, hauteur : 3,2 cm,
 Longueur max. du bandeau LED, en mm : 20
 Diffuseur en option

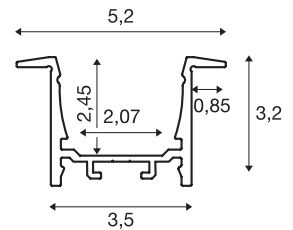

IP 20

Longueur (cm)	Coloris	Matière	Ref.	CHF
300	● noir	aluminium	1000498	144.00
	○ blanc		1000497	144.00

ACCESSOIRES

GRAZIA 20 Diffuseur, 3 m, plat



Description	Coloris	Longueur (cm)	Largeur (cm)	Hauteur (cm)	Matière	Ref.	CHF
Diffuseur	<input type="radio"/> dépoli	300	3,2	0,6	Polycarbonate (PC)	1000540	41.60
	<input type="radio"/> dépoli				Polyméthacrylate de méthyle (PMMA)	1000546	55.00
	<input type="radio"/> opale					1000549	55.00

GRAZIA 20 Connecteur longitudinal



Description	Coloris	Longueur (cm)	Largeur (cm)	Hauteur (cm)	Matière	Ref.	CHF
Connecteur longitudinal	<input checked="" type="radio"/> alu brossé	3,8	1,4	0,4	aluminium	1000571	17.00

Vendu par : 2 pièces

GRAZIA 20 Embouts pour profil en saillie

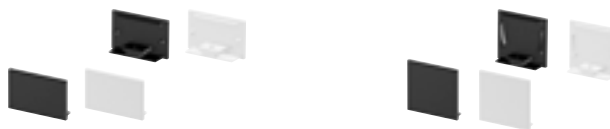

Description	Coloris	Longueur (cm)	Largeur (cm)	Hauteur (cm)	Matière	Ref.	CHF
Embout	<input checked="" type="radio"/> noir, plat	-	3,5	2,2	aluminium	1000561	12.75
	<input type="radio"/> blanc, plat					1000560	12.75
Embout	<input checked="" type="radio"/> noir, standard	-	3,5	3,2	aluminium	1000567	12.75
	<input type="radio"/> blanc, standard					1000566	12.75

Vendu par : 2 pièces

GRAZIA 20
Embout pour profil à encastrer



Description	Coloris	Longueur (cm)	Largeur (cm)	Hauteur (cm)	Matière	Ref.	CHF
Embout	<input checked="" type="radio"/> noir	-	5,2	3,2	aluminium	1000558	13.50
	<input type="radio"/> blanc					1000557	13.50

Vendu par : 2 pièces

GRAZIA 20
Suspension rigide



Description	Coloris	Longueur (cm)	Matière	Ref.	CHF
Suspension rigide	<input type="radio"/> argent	200	Acier	1000535	35.20

Vendu par : 2 pièces

GRAZIA 20
Clips de montage



Description	Coloris	Longueur (cm)	Largeur (cm)	Hauteur (cm)	Matière	Ref.	CHF
Clip de montage	<input type="radio"/> argent	2	3	0,8	Acier	1000536	4.10
Clip de montage	<input checked="" type="radio"/> chrome / alu brossé	5,5	7	2,3	Acier / aluminium	1004932	27.70

Vendu par : 2 pièces



GRAZIA 60

Profil en saillie

Matière : aluminium
 Largeur : 7 cm, hauteur : 9,5 cm,
 Longueur max. du bandeau LED, en mm : 20
 Diffuseur en option

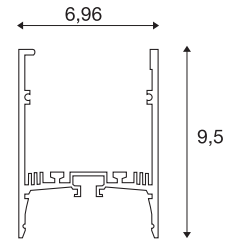
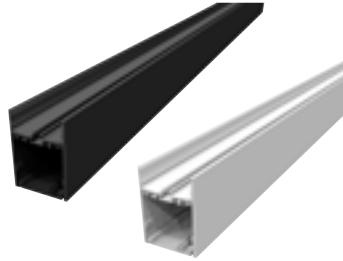

Longueur (cm)	Coloris	Matière	Ref.	CHF
150	● noir	aluminium	1004896	135.00
150	○ blanc		1004897	135.00
300	● noir	aluminium	1004898	269.00
300	○ blanc		1004899	269.00

GRAZIA 60

Profil à encastrer 1,5 m

Matière : aluminium
 Largeur : 8,6 cm, hauteur : 3,3 cm,
 Longueur max. du bandeau LED, en mm : 20
 Diffuseur en option

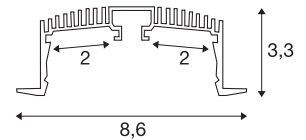
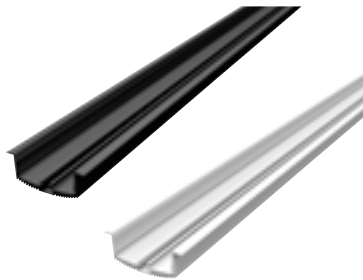

Longueur (cm)	Coloris	Matière	Ref.	CHF
150	● noir	aluminium	1004905	88.00
150	○ blanc		1004906	88.00
300	● noir	aluminium	1004907	179.00
300	○ blanc		1004908	179.00

ACCESSOIRES

GRAZIA 60 Diffuseur 1,5 m



Description	Coloris	Longueur (cm)	Largeur (cm)	Hauteur (cm)	Matière	Ref.	CHF
Diffuseur 1,5 m	<input checked="" type="radio"/> noir	150	6,5	0,65	aluminium	1004912	42.65
	<input type="radio"/> blanc					1004913	42.65
	<input type="radio"/> dépoli				Polycarbonate (PC)	1004914	21.30
	<input type="radio"/> dépoli				Polyméthacrylate de méthyle (PMMA)	1004916	27.70
Diffuseur 3 m	<input type="radio"/> dépoli	300	6,5		Polycarbonate (PC)	1004915	42.65
	<input type="radio"/> dépoli			Polyméthacrylate de méthyle (PMMA)	1004917	53.00	

GRAZIA 60 Embouts

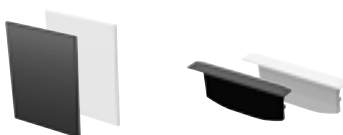

Description	Coloris	Longueur (cm)	Largeur (cm)	Hauteur (cm)	Matière	Ref.	CHF
Embouts pour profil en saillie	<input checked="" type="radio"/> noir	-	7	9,5	aluminium	1004900	13.80
	<input type="radio"/> blanc	-				1004901	13.80
Embouts pour profil à encastrer	<input checked="" type="radio"/> noir	-	8,6	3,3	aluminium	1004909	9.50
	<input type="radio"/> blanc	-				1004910	9.50

Vendu par : 2 pièces

GRAZIA 60 Profil en saillie, accessoire de montage



Description	Coloris	Longueur (cm)	Largeur (cm)	Hauteur (cm)	Matière	Ref.	CHF
Profil de montage	<input checked="" type="radio"/> noir	150	6,1	1,2	aluminium	1004902	49.10

GRAZIA 60
 Profil en saillie,
 connecteur longitudinal



Description	Coloris	Longueur (cm)	Largeur (cm)	Hauteur (cm)	Matière	Ref.	CHF
Connecteur longitudinal	● alu brossé	8	4,2	1	aluminium	1004903	13.80

Vendu par : 2 pièces

GRAZIA 60
 Profil en saillie, kit d'alimentation



Description	Coloris	Longueur (cm)	Largeur (cm)	Hauteur (cm)	Matière	Ref.	CHF
Kit alimentation	● alu brossé	8	4,2	2,4	aluminium	1004904	13.80

GRAZIA 60
 Profil à encastrer, clip de fixation



Description	Coloris	Longueur (cm)	Largeur (cm)	Hauteur (cm)	Matière	Ref.	CHF
Clip de fixation	● chrome	13	2,8	4	aluminium	1004911	18.00

Vendu par : 2 pièces

CONTRÔLEUR
 Bandeau LED CCT / RGB W



Description	Coloris	Longueur (cm)	Largeur (cm)	Hauteur (cm)	Matière	Ref.	CHF
Contrôleur	○ blanc	14,5	4,65	1,6	Polycarbonate (PC)	1006348	95.90

CONCEVEZ VOTRE PROFIL LED

Éclairez des pièces entières ou ajoutez des touches
de lumière – disponible jusqu'à 700lm par 5 m.

Jouez sur les couleurs – Des bandeaux
LED blancs, disponibles en versions CCT
(Tunable White) ou RGB W.

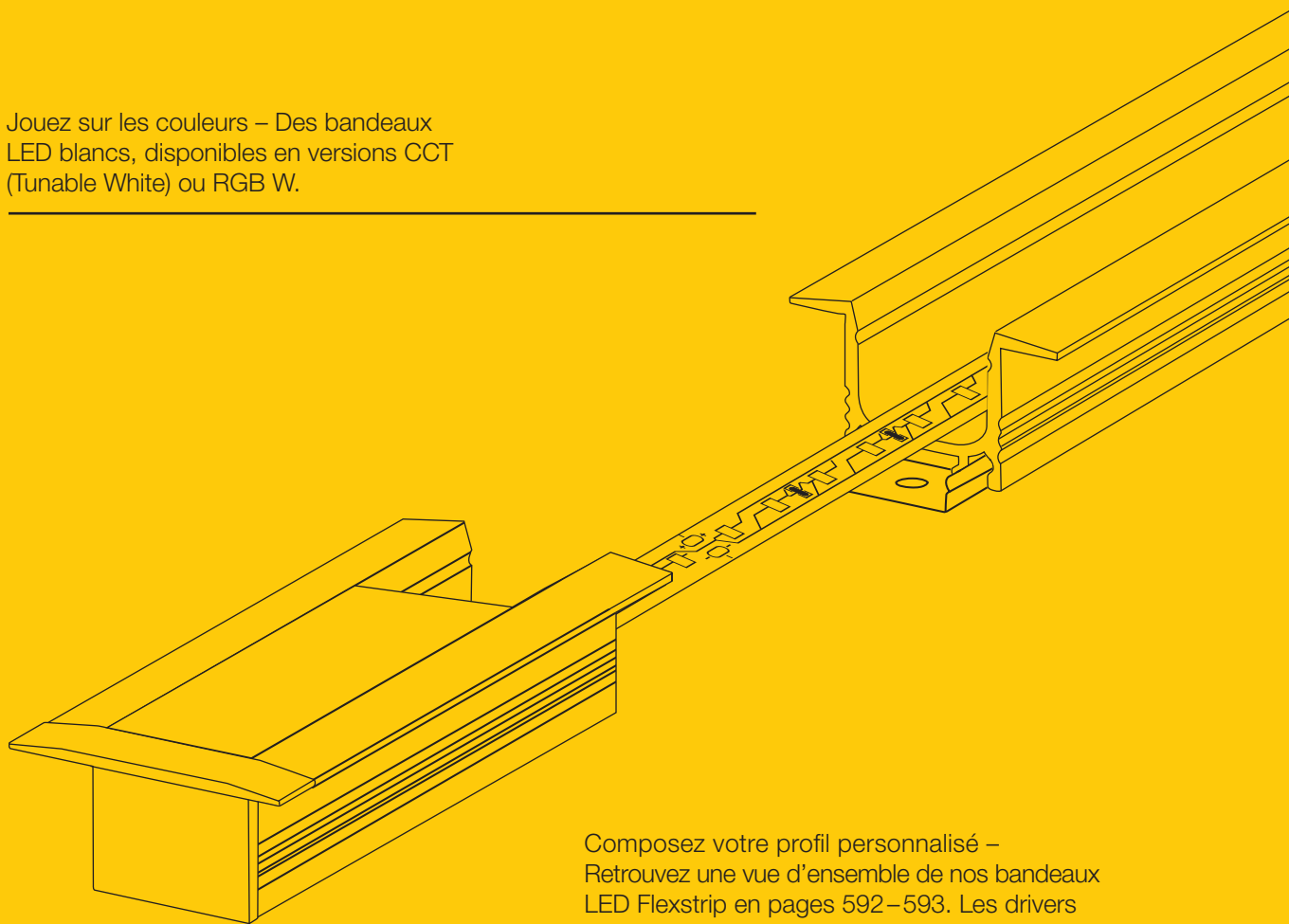

Composez votre profil personnalisé –
Retrouvez une vue d'ensemble de nos bandeaux
LED Flexstrip en pages 592–593. Les drivers
compatibles sont présentés dans la rubrique
Accessoires en pages 592–593.



Nous recommandons
d'alimenter les bandeaux de plus
de 3 m des deux côtés
et d'ajouter une alimentation
supplémentaire tous
les 5 m.

Dépoli, opale ou transparent, en version plate
ou haute – Choisissez vos options personnalisées
parmi nos différents diffuseurs.

Pour l'intérieur, l'extérieur ou les pièces humides.
Une protection IP20 ou IP54 pour faire face à
toutes les situations.

Profil en saillie standard ou plat, profil encastré
ou profil d'angle – Nous avons le modèle qui
correspond à votre projet.

Avec des longueurs de 5 m à 80 m, rien ne
vous arrête – vous pouvez adapter votre solution
à la situation. Grâce à une technologie 24V,
vous réalisez des éclairages de longueur plus
importante avec moins de points d'alimentation.



GRAZIA FLEXSTRIP LED 24V

LED par mètre : 70
 Largeur : 1 cm
 Hauteur : 0,12 cm.
 Écart entre les LED : 1,4 cm
 Section possible tous les 10 cm
 Indice de protection : IP 20
 Câble d'alimentation des deux côtés



Température de couleur (K)	Flux lumineux (lm)	Puissance (W)	Indice de rendu des couleurs (IRC)	Constance des couleurs (SDMC)	Longueur (cm)	Ref.	CHF
2700	3500	44	90	3	500	1004708	102.00
3000	3500	44				1004709	
4000	3750	44				1004710	



Modèle	Matière	Longueur (cm)	Largeur (cm)	Hauteur (cm)	Ref.	CHF
○ Alimentation LED 50W, triac dim	Polycarbonate (PC)	18.4	6.1	3.2	1003104	64.00
○ Alimentation LED 25W, triac dim		12.8	5.2	3	1006336	41.90
○ Alimentation LED 30W, Slim Line, on/off		30	3	1.6	1007250	57.50
○ Alimentation LED 30W, Slim Line, DALI				1.8	1007254	69.00
○ Alimentation LED 100W, Slim Line, on/off		35	3	1.8	1007251	92.00
○ Alimentation LED 100W, Slim Line, DALI				1.8	1007255	126.50



GRAZIA PRO FLEXSTRIP 24V

LED par mètre : 126
 Largeur : 1 cm
 Hauteur : 0,12 cm.
 Écart entre les LED : 0,8 cm
 Section possible tous les 5,6 cm
 Indice de protection : IP 20
 Câble d'alimentation des deux côtés



Température de couleur (K)	Flux lumineux (lm)	Puissance (W)	Indice de rendu des couleurs (IRC)	Constance des couleurs (SDMC)	Longueur (cm)	Ref.	CHF
2700	6500	73	90	3	500	1004712	169.00
3000	6500	73				1004713	
4000	7000	73				1004714	



Modèle	Matière	Longueur (cm)	Largeur (cm)	Hauteur (cm)	Ref.	CHF
○ Alimentation LED 50W, triac dim	Polycarbonate (PC)	18.4	6.1	3.2	1003104	64.00
○ Alimentation LED 25W, triac dim		12.8	5.2	3	1006336	41.90
○ Alimentation LED 30W, Slim Line, on/off		30	3	1.6	1007250	57.50
○ Alimentation LED 30W, Slim Line, DALI				1.8	1007251	92.00
○ Alimentation LED 100W, Slim Line, on/off		35	3	1.8	1007255	126.50
○ Alimentation LED 100W, Slim Line, DALI				1.8	1007255	126.50

Pour assurer la dissipation de chaleur, les bandeaux LED doivent être collés sur un profil en aluminium. Bande adhésive sur la face arrière du bandeau LED.
 Pour obtenir une lumière homogène à partir d'une longueur de 3 m, les bandeaux doivent être alimentés des deux côtés.
 Prévoir une alimentation supplémentaire tous les 5 m.



GRAZIA PRO FLEXSTRIP 24V

LED par mètre : 168
 Largeur : 1 cm
 Hauteur : 0,12 cm.
 Écart entre les LED : 0,6 cm
 Section possible tous les 4,2 cm
 Indice de protection : IP 20
 Câble d'alimentation des deux côtés



Température de couleur (K)	Flux lumineux (lm)	Puissance (W)	Indice de rendu des couleurs (IRC)	Constance des couleurs (SDMC)	Longueur (cm)	Ref.	CHF
2700	8500	91	90	3	500	1004716	192.00
3000	8500	91				1004717	
4000	9100	91				1004718	
6500	9100	91				1004719	



Modèle	Matière	Longueur (cm)	Largeur (cm)	Hauteur (cm)	Ref.	CHF
○ Alimentation LED 50W, triac dim	Polycarbonate (PC)	18.4	6.1	3.2	1003104	64.00
○ Alimentation LED 25W, triac dim		12.8	5.2	3	1006336	41.90
○ Alimentation LED 30W, Slim Line, on/off		30	3	1.6	1007250	57.50
○ Alimentation LED 30W, Slim Line, DALI				1.8	1007251	92.00
○ Alimentation LED 100W, Slim Line, on/off		35	3	1.8	1007255	126.50
○ Alimentation LED 100W, Slim Line, DALI				1.8	1007255	126.50



GRAZIA PRO MAX FLEXSTRIP 24V

LED par mètre : 196
 Largeur : 2 cm
 Hauteur : 0,15 cm.
 Écart entre les LED : 0,5 cm
 Section possible tous les 3,6 cm
 Indice de protection : IP 20
 Câble d'alimentation des deux côtés



Température de couleur (K)	Flux lumineux (lm)	Puissance (W)	Indice de rendu des couleurs (IRC)	Constance des couleurs (SDMC)	Longueur (cm)	Ref.	CHF
3000	12500	126	90	3	500	1004720	269.00
4000	13000	126				1004721	



Modèle	Matière	Longueur (cm)	Largeur (cm)	Hauteur (cm)	Ref.	CHF
<input type="radio"/> Alimentation LED 150W, Slim Line, on/off	Polycarbonate (PC)	35	3	1.8	1007252	115.00
<input type="radio"/> Alimentation LED 150W, Slim Line, DALI					1007256	161.00

Pour assurer la dissipation de chaleur, les bandeaux LED doivent être collés sur un profil en aluminium. Bande adhésive sur la face arrière du bandeau LED.
 Pour obtenir une lumière homogène à partir d'une longueur de 3 m, les bandeaux doivent être alimentés des deux côtés.
 Prévoir une alimentation supplémentaire tous les 5 m.



GRAZIA PRO MAX FLEXSTRIP 24V

LED par mètre : 196
 Largeur : 2 cm
 Hauteur : 0,15 cm.
 Écart entre les LED : 1 cm
 Section possible tous les 7,1 cm
 Indice de protection : IP 20
 Câble d'alimentation des deux côtés



Température de couleur (K)	Flux lumineux (lm)	Puissance (W)	Indice de rendu des couleurs (IRC)	Constance des couleurs (SDMC)	Longueur (cm)	Ref.	CHF
3000	20000	193	90	3	500	1004722	520.00
4000	21400					1004723	



Modèle	Matière	Longueur (cm)	Largeur (cm)	Hauteur (cm)	Ref.	CHF
○ Alimentation LED 250W, Slim Line, on/off	Polycarbonate (PC)	40	4	2.2	1007253	138.00
○ Alimentation LED 250W, Slim Line, DALI					1007257	184.00



GRAZIA PRO FLEXSTRIP tunable white, 24V

LED par mètre : 224
 Largeur : 1 cm
 Hauteur : 0,12 cm.
 Écart entre les LED : 0,9 cm
 Section possible tous les 6,3 cm
 Indice de protection : IP 20
 Câble d'alimentation des deux côtés



Température de couleur (K)	Flux lumineux (lm)	Puissance (W)	Indice de rendu des couleurs (IRC)	Constance des couleurs (SDMC)	Longueur (cm)	Ref.	CHF
2700-6500	3400-3700	40	90	6	500	1004725	202.00



Modèle	Matière	Longueur (cm)	Largeur (cm)	Hauteur (cm)	Ref.	CHF
<input type="radio"/> DALI Controller 1 Canal, push-dim	Polycarbonate (PC)	11.6	4.2	1.8	1003106	78.00
<input type="radio"/> Alimentation LED 60W, DALI, 2 canaux		20.2	5.8	3	1006133	182.00
<input type="radio"/> SMART Controller 1-5 canaux, sélectionnables par DIP		14.5	4.65	1.6	1006348	95.90
<input type="radio"/> Alimentation LED 100W, Slim Line, on/off		35	3	1.8	1007251	92.00
<input type="radio"/> Alimentation LED 100W, Slim Line, DALI					1007255	126.50

Pour assurer la dissipation de chaleur, les bandeaux LED doivent être collés sur un profil en aluminium. Bande adhésive sur la face arrière du bandeau LED.
 Pour obtenir une lumière homogène à partir d'une longueur de 3 m, les bandeaux doivent être alimentés des deux côtés.
 Prévoir une alimentation supplémentaire tous les 5 m.



GRAZIA PRO FLEXSTRIP RGBW, 24V

LED par mètre : 70
 Largeur : 1,2 cm
 Hauteur : 0,22 cm.
 Écart entre les LED : 1,4 cm
 Section possible tous les 10 cm
 Indice de protection : IP 20
 Câble d'alimentation des deux côtés



Température de couleur (K)	Flux lumineux (lm)	Puissance (W)	Indice de rendu des couleurs (IRC)	Constance des couleurs (SDMC)	Longueur (cm)	Ref.	CHF
RGB	2500	60	90	6	500	1004727	192.00
W 3000	2050	27					



Modèle	Matière	Longueur (cm)	Largeur (cm)	Hauteur (cm)	Ref.	CHF
<input type="radio"/> SMART Controller 1-5 canaux, sélectionnables par DIP	Polycarbonate (PC)	14.5	4.65	1.6	1006348	95.90
<input type="radio"/> Alimentation LED 100W, Slim Line, on/off		35	3	1.8	1007251	92.00

Pour assurer la dissipation de chaleur, les bandeaux LED doivent être collés sur un profil en aluminium. Bande adhésive sur la face arrière du bandeau LED.
 Pour obtenir une lumière homogène à partir d'une longueur de 3 m, les bandeaux doivent être alimentés des deux côtés.
 Prévoir une alimentation supplémentaire tous les 5 m.

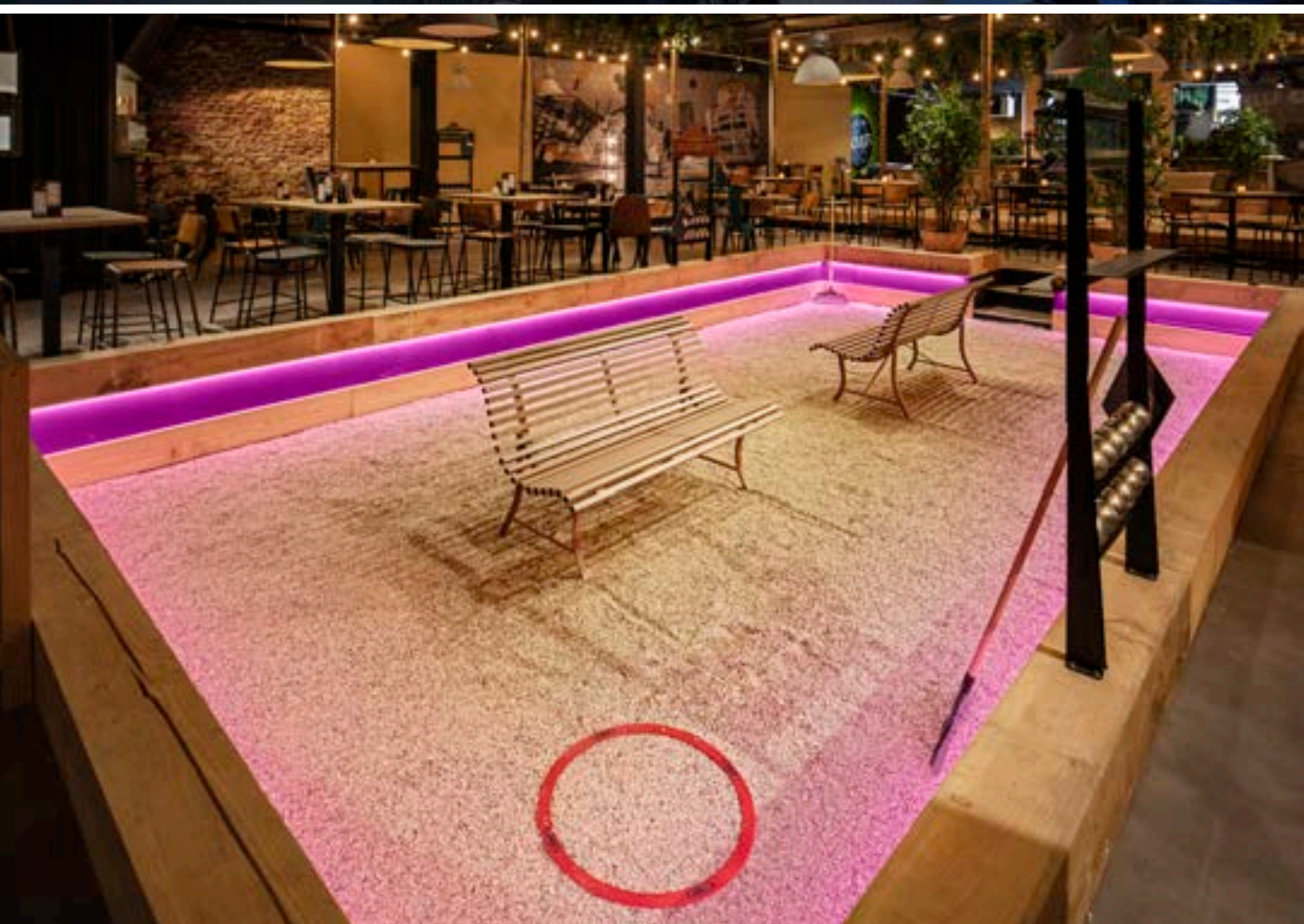

GRAZIA IP FLEXSTRIP 24V

LED par mètre : 70
 Largeur : 1,2 cm
 Hauteur : 0,4 cm.
 Écart entre les LED : 1,4 cm
 Section possible tous les 10 cm
 Indice de protection : IP 54
 Câble d'alimentation des deux côtés



Température de couleur (K)	Flux lumineux (lm)	Puissance (W)	Indice de rendu des couleurs (IRC)	Constance des couleurs (SDMC)	Longueur (cm)	Ref.	CHF
2700	3350					1004734	
3000	3350	44	90	4	502	1004735	135.00
4000	3600					1004736	

GRAZIA IP FLEXSTRIP tunable white, 24V

LED par mètre : 224
 Largeur : 1,2 cm
 Hauteur : 0,4 cm.
 Écart entre les LED : 0,9 cm
 Section possible tous les 6,3 cm
 Indice de protection : IP 54
 Câble d'alimentation des deux côtés



Température de couleur (K)	Flux lumineux (lm)	Puissance (W)	Indice de rendu des couleurs (IRC)	Constance des couleurs (SDMC)	Longueur (cm)	Ref.	CHF
2700-6500	3210-3500	40	90	4	502	1004726	235.00

2 embouts et matériel de fixation inclus

GRAZIA IP FLEXSTRIP RGBW, 24V

LED par mètre : 70
 Largeur : 1,4 cm
 Hauteur : 0,46 cm.
 Écart entre les LED : 1,4 cm
 Section possible tous les 10 cm
 Indice de protection : IP 54
 Câble d'alimentation des deux côtés



Température de couleur (K)	Flux lumineux (lm)	Puissance (W)	Indice de rendu des couleurs (IRC)	Constance des couleurs (SDMC)	Longueur (cm)	Ref.	CHF
RGB	2350	60	90	6	502	1004737	259.00
W 3000	1958	27					

Pour assurer la dissipation de chaleur, les bandeaux LED doivent être collés sur un profil en aluminium. Bande adhésive sur la face arrière du bandeau LED.
 Pour obtenir une lumière homogène à partir d'une longueur de 3 m, les bandeaux doivent être alimentés des deux côtés.
 Prévoir une alimentation supplémentaire tous les 5 m.

FLEXSTRIPS

VUE D'ENSEMBLE

GRAZIA LED

1004708
1004709
1004710

70 LED/m

GRAZIA PRO

1004712
1004713
1004714

126 LED/m

GRAZIA PRO

1004716
1004717
1004718
1004719

168 LED/m

GRAZIA PRO MAX

1004720
1004721

196 LED/m

GRAZIA PRO MAX

1004722
1004723

196 LED/m

500
cm

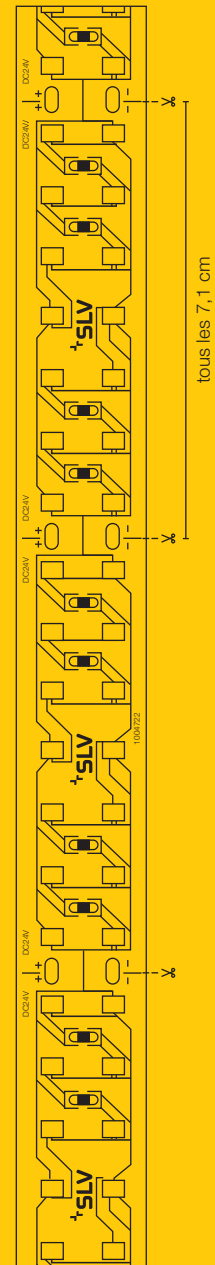
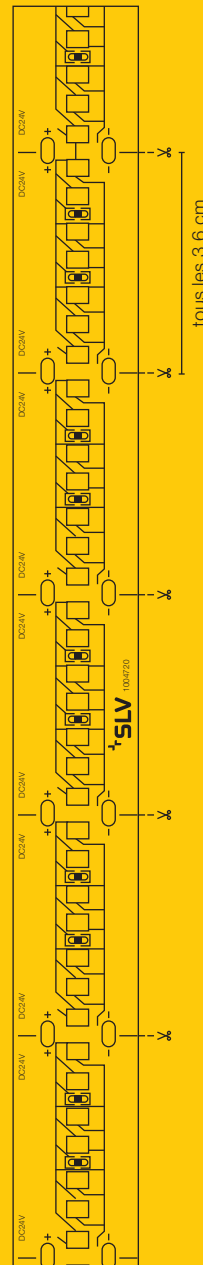
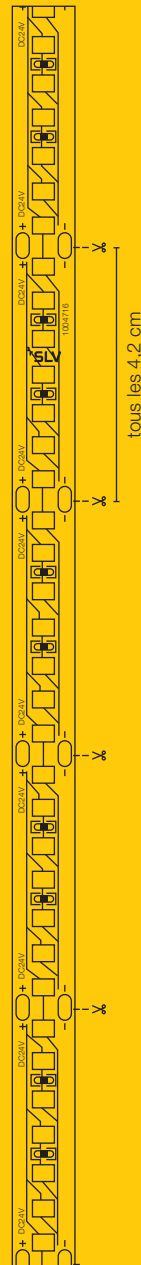
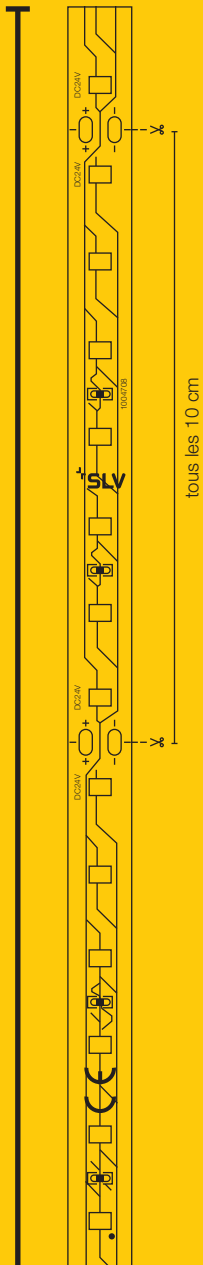



Tous les bandeaux LED GRAZIA fonctionnent sur 24V. Vous trouverez les drivers et autres accessoires compatibles en page 582.



**GRAZIA
PRO MAX**
TUNABLE WHITE
1004725

224 LED/m

**GRAZIA
PRO MAX**
RGBW
1004727

70 LED/m

**GRAZIA
IP**
1004734
1004735
1004736

70 LED/m

**GRAZIA
IP**
TUNABLE WHITE
1004726

224 LED/m

**GRAZIA
IP**
RGBW
1004737

70 LED/m

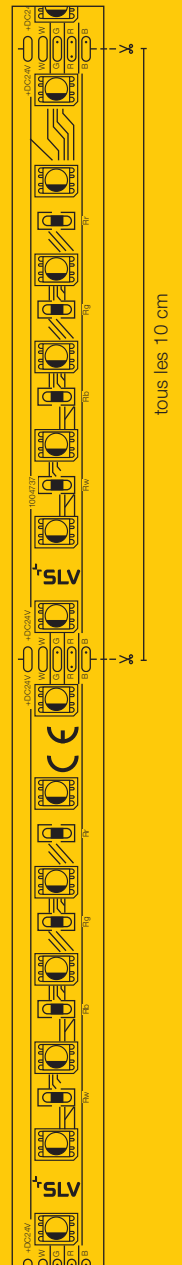
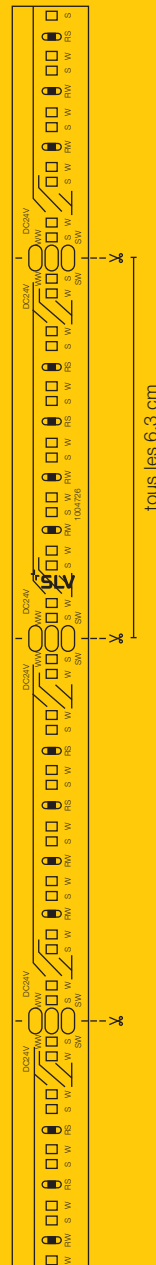
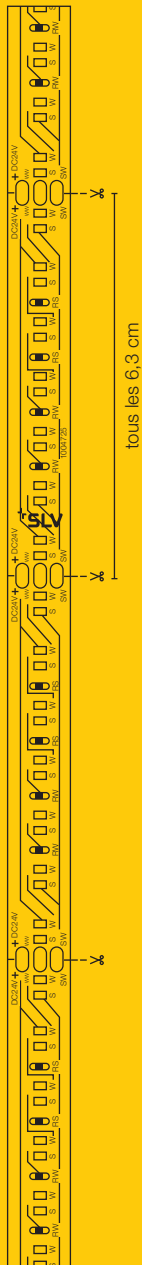



NEW

LED
VINOLINA ONE | 597



NEW

LED
VINOLINA | 597



NEW

LED
VINOLINA TWO | 599



LED
TONILA | 601



NEW

LED
TAHA | 601



NEW

SCKET
S-TUBE 32/75 | 603



NEW

SCKET
PHOTONI 45/75 | 605



NEW

LED
S-CUBE 35/75 | 607



NEW

LED
R-CUBE 35/70 | 609



NEW

LED
LID I 75 | 611

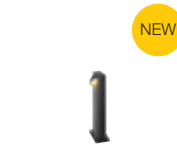

NEW

LED
LID I 45 | 611



NEW

LED
I-RING | 613



NEW

LED
M-POL S | 614



NEW

LED
M-POL S | 615



LED
M-POL S | 616



LED
M-POL S | 617



LED
M-POL S | 618



LED
M-POL M | 619



LED
M-POL M | 620



LED
M-POL M | 621



M-POL 30/60/90 | 623



SCKET
CONCRETO | 627



SCKET
CONCRETO | 627



LED
ESKINA
FRAME 45/75 | 629



LED
ESKINA
FRAME 75 | 629



LED
ESKINA
FRAME
125/175 | 630



LED
ESKINA 30/80 | 631



LED
LOGS 40/70 | 633



SCKET
GRAFIT 30/60/90 | 635



SCKET
GRAFIT 30/60/90 | 637



LED
QUADRULO | 639



LED
RUSTY®
SLOT 50/80 | 640



SCKET
RUSTY®
SLOT 50/80 | 641



SCKET
RUSTY®
PATHLIGHT | 642



LED
RUSTY® 40/70 | 643



SCKET
RUSTY® 40/70 | 643



SCKET
RUSTY®
CONE 24 | 645



SCKET
RUSTY®
CONE 40/70 | 645



SCKET
RUSTY® 40/70 | 646



SCKET
ARROCK
GRANITE 40/70 | 647



SCKET
ARROCK
ARC | 648



LED
ARROCK
STONE 50/75 | 649



SCKET
ARROCK SLOT | 649



LED
L-LINE OUT 30 | 650



LED
L-LINE OUT 60 | 651



LED
L-LINE OUT 50/80 | 651



SCKET
THEO PATHLIGHT | 652



LED
OVALISK 75/100 | 653



SCKET
GLOO PURE 27/44/70 | 655



SCKET
ROTOBALL 25/40/50 | 657



SCKET
PHOTONIA | 659



SCKET
PHOTONIA | 659



SCKET
OTOS GLAS | 659



SCKET
CUBIX | 660



SCKET
CONE | 660



SCKET
MOLAT | 661



SCKET
MOLAT | 661



SCKET
LISENNE 40/70 | 662



SCKET
ADEGAN MANILA | 663



SCKET
ADEGAN | 663



SCKET
ALPA MUSHROOM 45/75 | 665



SCKET
ALPA CONE 100 | 665



LED
APONI 90/120 | 666



LED
TRUST 30/60 | 667



SCKET
BIG NAILS 50/80 | 668



SCKET
ROX ACRYL 30/60/90 | 669



SCKET
VAP SLIM 30/60/90 | 671



SCKET
C-POL | 672



SCKET
F-POL | 672



SCKET
SQUARE POLE 30/60/90 | 673



LED
SLOTS 45/65 | 675



LED
H-POL 30/60 | 676



LED
H-POL TWIN 30/60 | 677



LED
SLOTBOX 40/70 | 678



LED
FLATT 65/100 | 679



LED
ABRIDOR 60/100 | 681



LED
IPERI 50 | 681



SCKET
QUADRASYL 75 | 682



LED
QUAD POLE | 683



LED
BOOKAT | 683



LED
RASCALI 45/65 | 684



SCKET
MYRA SPOT | 685



SCKET
SITRA 360 | 685



1007357 597

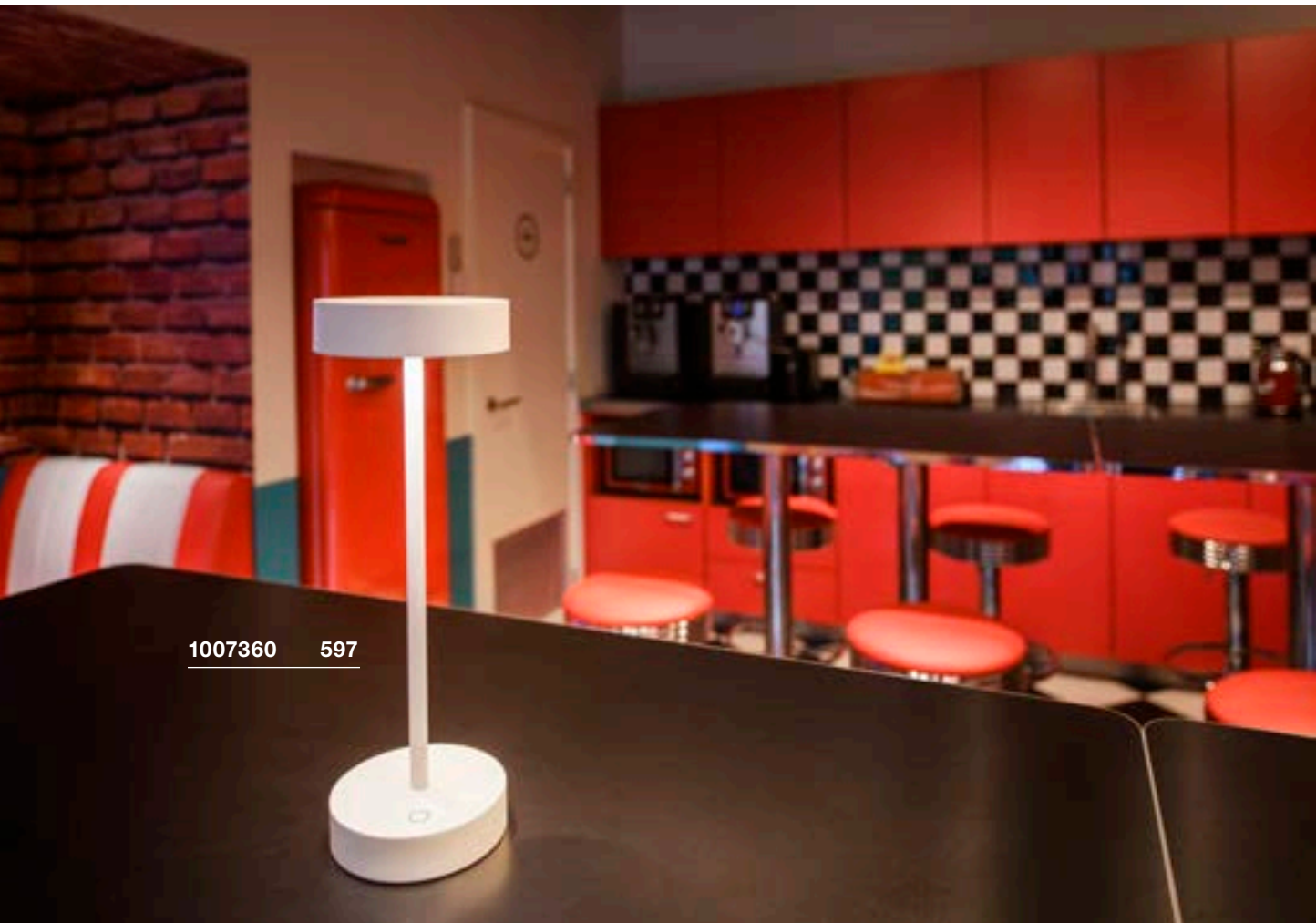

1007360 597



VINOLINA ONE TL, sans fil

VINOLINA TL, sans fil

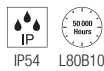
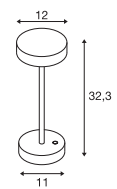
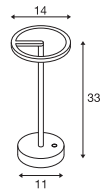
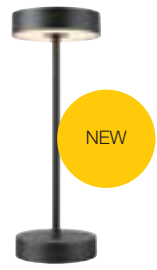
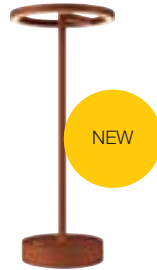

Fonctionne sur batterie 5V
Puissance totale : 2,5W
Matière : aluminium

- Autonomie : 12 h
- Rechargement : 7 h
- Dalle de chargement incluse
- Alimentation non fournie
- USB A

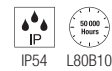

Fonctionne sur batterie 5V
Puissance totale : 2,2W
Matière : aluminium

- Autonomie : 12 h
- Rechargement : 7 h
- Dalle de chargement incluse
- Alimentation non fournie
- USB A



Down 125lm | 2700K



Down 130lm | 2700K | 130lm | 3000K

Coloris	Ref.	CHF
● noir	1007359	159.90
○ blanc	1007357	159.90
● rouille	1007358	159.90

Coloris	Ref.	CHF
● noir	1007362	159.90
○ blanc	1007360	159.90
● rouille	1007361	159.90



1007697 599



VINOLINA TWO

TL, sans fil

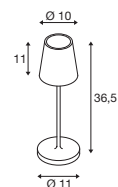

IP65 L70B20

Fonctionne sur batterie 5V

Puissance totale : 2W

Matière : aluminium

- Variation à commande tactile
- Autonomie : 10 h
- Rechargement : 5 h
- Avec station de rechargement pour un luminaire



Down

190lm

2200K
2700K
3000K

Coloris	Ref.	CHF
● noir	1007693	159.90
○ blanc	1007692	159.90
● sable	1007697	159.90
● rouille	1007695	159.90
● rouge	1007694	159.90
● vert tilleul	1007696	159.90





TONILA TL

TAHA Kit de luminaires, sans fil

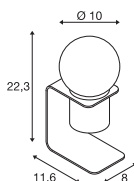

Fonctionne sur batterie 5V
Puissance totale : 1,6W
Matière : aluminium / plastique

- Batterie 3,6V 2000mAh fournie
- Alimentation non fournie. Nécessite un chargeur USB 5V DC/1-2A. Pour câble de chargement Mini USB
- Variation d'intensité via un bouton à 3 positions



Down 90lm | 2700K

Coloris	Ref.	CHF
● noir	1002583	149.00

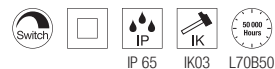

100-240V ~50/60Hz | Fonctionnement sur batterie 5V
Puissance totale : 5W
Tension de sortie max. driver : 5V DC
Matière : aluminium / plastique

- Câble de chargement inclus



Down 200lm | 2700K

Coloris	Ref.	CHF
● noir	1007380	182.90

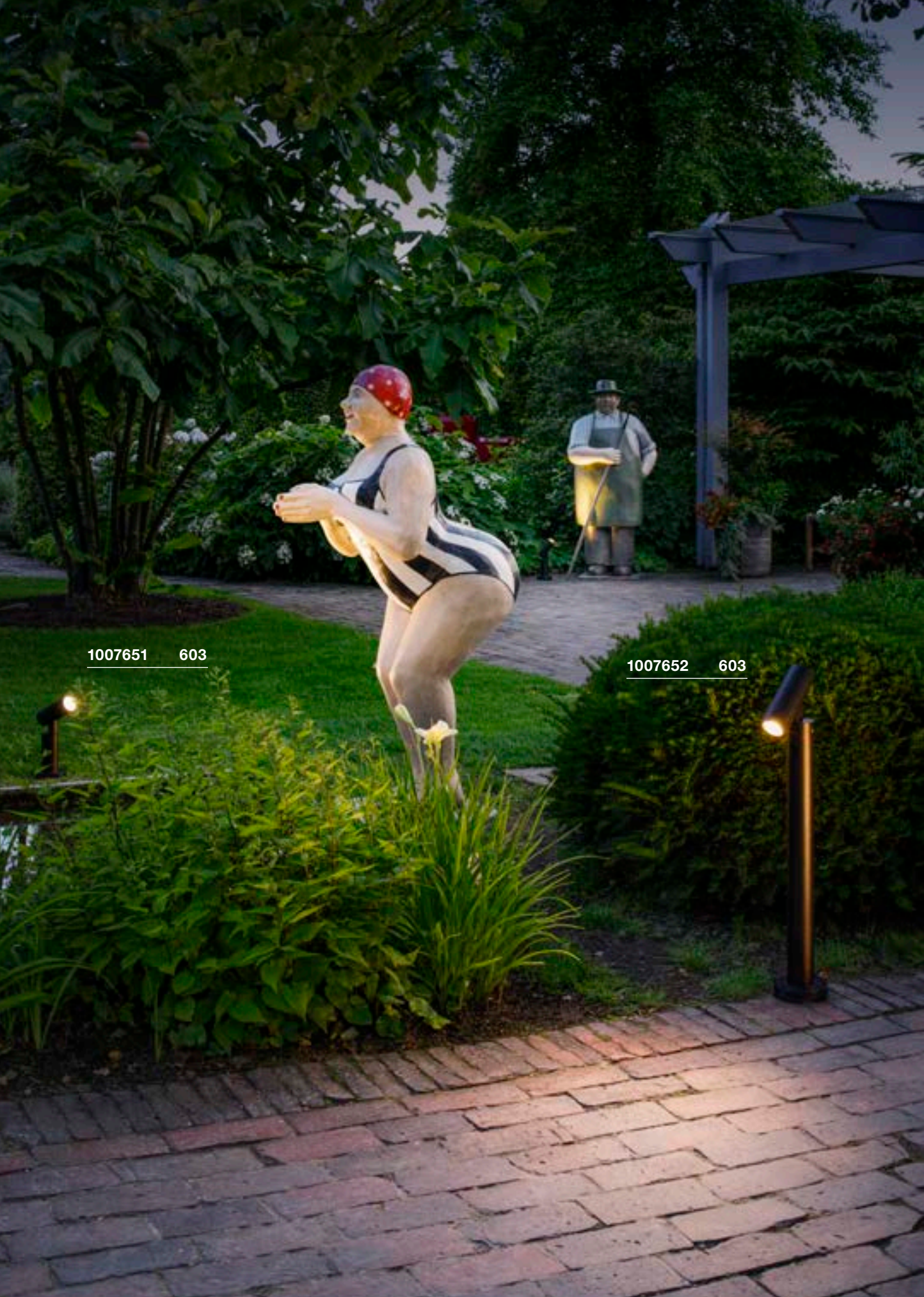

1007651 603

1007652 603



S-TUBE 32

Borne, GU10

S-TUBE 75

Borne, GU10

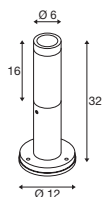

220-240V ~50/60Hz
Matière : aluminium

- Câble nu



Douille : 1xGU10 Ø max. : 5 cm L : 5,5 cm

Coloris	Ref.	CHF
● noir	1007651	● 96.60



LED GU10 51mm | 6W | 38°
2700SK | 450lm | CEE=F
6kWh / 1000h



Ref. : 1005077 | 10.60 CHF



Article	Ref.	CHF
Boîte de connexion IP68, 3 pôles		
● noir	228730	21.30

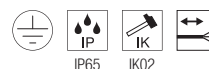

220-240V ~50/60Hz
Matière : aluminium

- Câble nu



Douille : 1xGU10 Ø max. : 5 cm L : 5,5 cm

Coloris	Ref.	CHF
● noir	1007652	● 154.10



LED GU10 51mm | 6W | 38°
2700SK | 450lm | CEE=F
6kWh / 1000h



Ref. : 1005077 | 10.60 CHF



Article	Ref.	CHF
Boîte de connexion IP68, 3 pôles		
● noir	228730	21.30



1007587 605

1007584 605



PHOTONI 45

Borne, E27

PHOTONI 75

Borne, E27

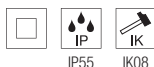
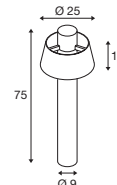
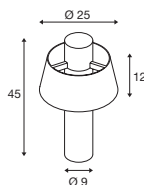
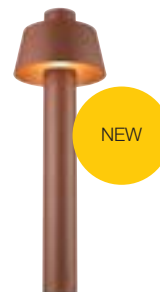

IP55 IK08

220-240V ~50/60Hz
Matière : aluminium

- Boîtier de raccordement IP
- Résiste à l'air marin

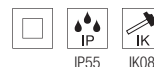

IP55 IK08

220-240V ~50/60Hz
Matière : aluminium

- Boîtier de raccordement IP
- Résiste à l'air marin



Douille : 1xE27 Ø max. : 6 cm L : 11,6 cm



Douille : 1xE27 Ø max. : 6 cm L : 11,6 cm

Coloris	Ref.	CHF
● noir	1007587	205.90
● rouille	1007583	205.90

Coloris	Ref.	CHF
● noir	1007584	228.90
● rouille	1007580	228.90



A60 | 7,5W | 180°
2700SK | 720lm | CEE=F
8kWh / 1000h



Ref. : 1005305 | 24.50 CHF



A60 | 7,5W | 180°
2700SK | 720lm | CEE=F
8kWh / 1000h



Ref. : 1005305 | 24.50 CHF

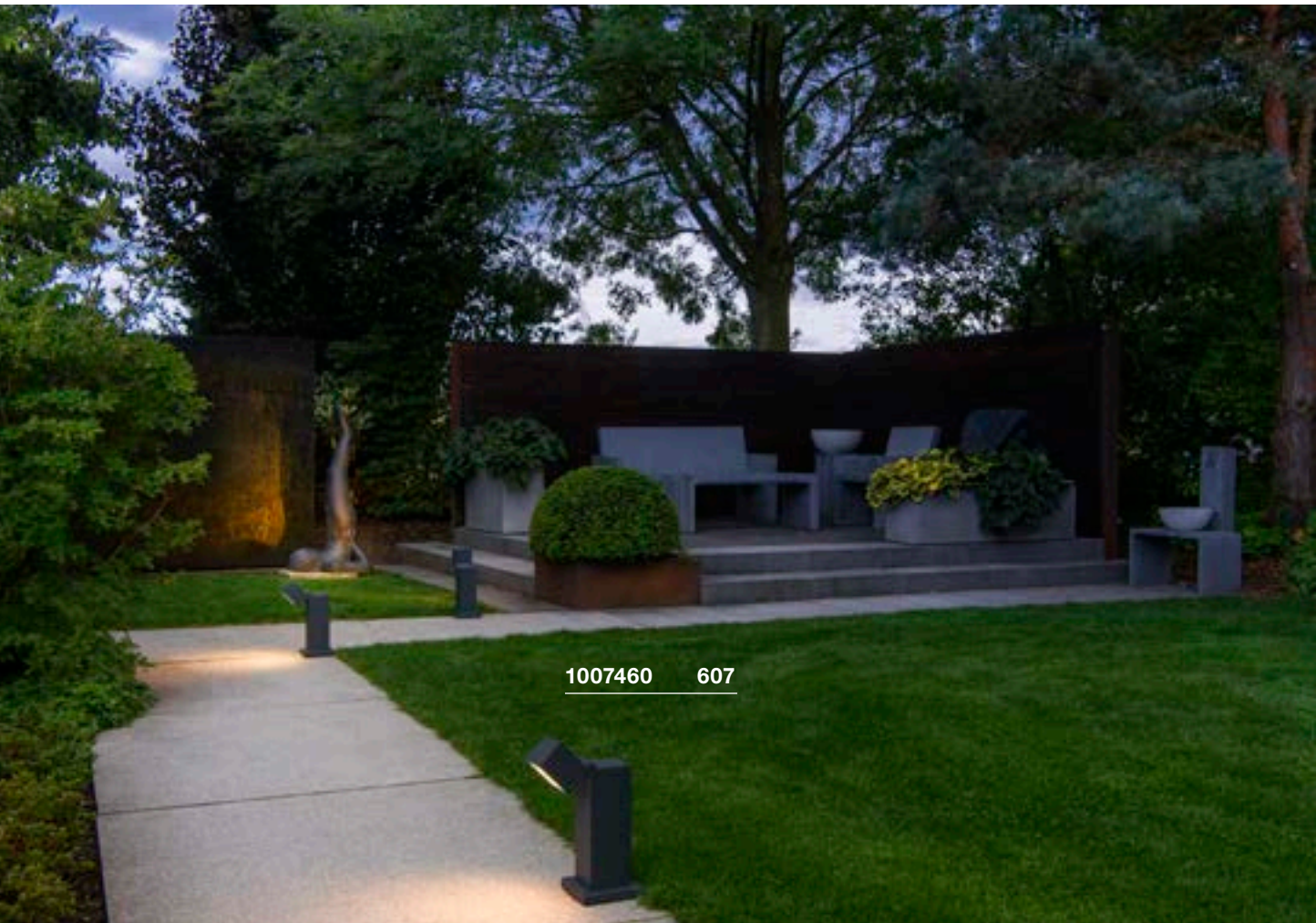



S-CUBE 35 Borne

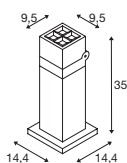

220-240V ~50/60Hz | 350mA
Puissance totale : 15W
Matière : aluminium

- Câble nu



Down 1000lm | 2700K | 1200lm | 3000K

Coloris	Ref.	CHF
● anthracite	1007460	● 228.90



Article	Ref.	CHF
Boîte de connexion IP68, 3 pôles		
● noir	228730	21.30

S-CUBE 75 Borne

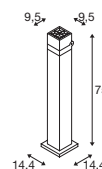

220-240V ~50/60Hz | 350mA
Puissance totale : 15W
Matière : aluminium

- Câble nu



Down 1000lm | 2700K | 1200lm | 3000K

Coloris	Ref.	CHF
● anthracite	1007459	● 269.10



Article	Ref.	CHF
Boîte de connexion IP68, 3 pôles		
● noir	228730	21.30



1007513 609



R-CUBE 35 Borne

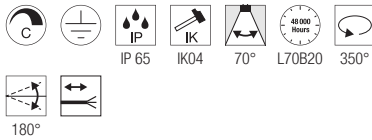
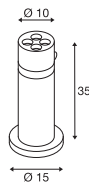
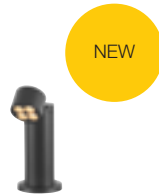

220-240V ~50/60Hz | 350mA
Puissance totale : 15W
Matière : aluminium

- Câble nu



Down 800lm | 2700K | 800lm | 3000K

Coloris	Ref.	CHF
● anthracite	1007513	● 228.90



Article	Ref.	CHF
Boîte de connexion IP68, 3 pôles		
● noir	228730	21.30

R-CUBE 75 Borne

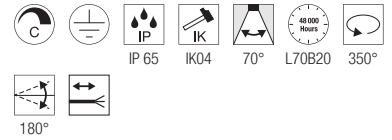
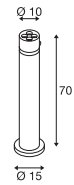

220-240V ~50/60Hz | 350mA
Puissance totale : 15W
Matière : aluminium

- Câble nu



Down 800lm | 2700K | 800lm | 3000K

Coloris	Ref.	CHF
● anthracite	1007512	● 269.10



Article	Ref.	CHF
Boîte de connexion IP68, 3 pôles		
● noir	228730	21.30



1007670 611

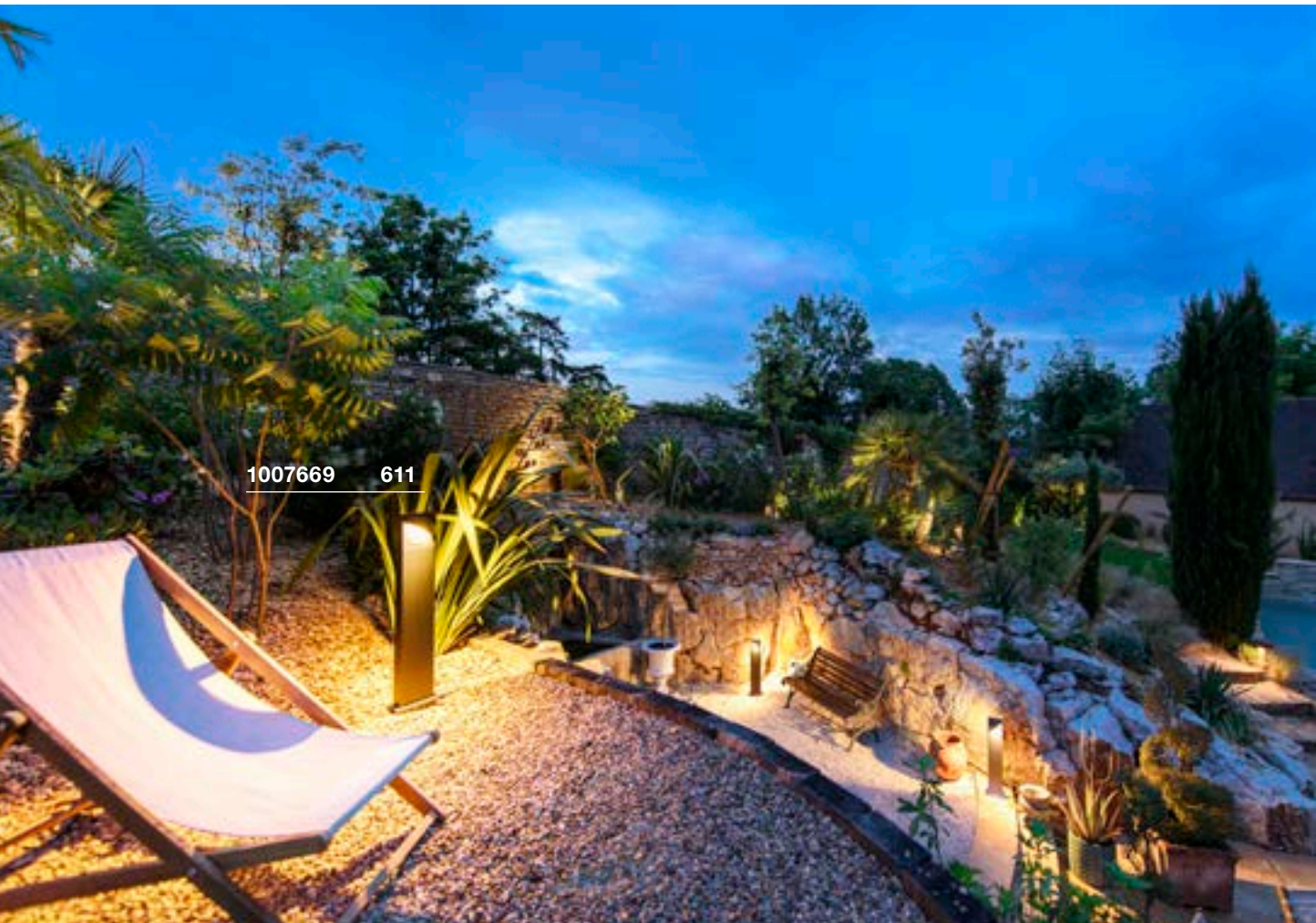

1007669 611



LID I 75 Borne, double

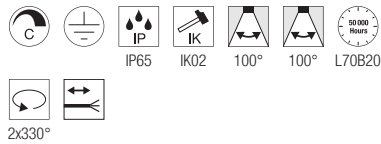
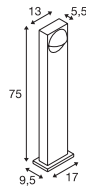

220-240V ~50/60Hz | 700mA
Puissance totale : 29W
Matière : aluminium

- Câble nu



Down 850lm | 2700K | 1000lm | 3000K

Coloris	Ref.	CHF
● anthracite	1007669	● 343.90



Article	Ref.	CHF
Boîte de connexion IP68, 3 pôles		
● noir	228730	21.30

LID I 45 Borne, simple

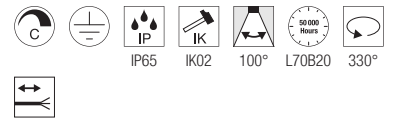
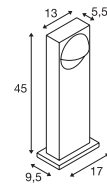

220-240V ~50/60Hz | 350mA
Puissance totale : 15W
Matière : aluminium

- Câble nu



Down 900lm | 2700K | 1050lm | 3000K

Coloris	Ref.	CHF
● anthracite	1007670	● 251.90



Article	Ref.	CHF
Boîte de connexion IP68, 3 pôles		
● noir	228730	21.30



1007237 613



I-RING Borne

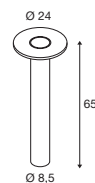

100-240V ~50/60Hz | 350mA
Puissance totale : 9,2W
Matière : aluminium



Down

670lm | 3000K

Coloris	Ref.	CHF
● anthracite	1007237	● 263.40



Article	Ref.	CHF
Kit de fixation		
● inox	228753	12.75

M-POL S
Tête de lampe 360°,
anti-éblouissement

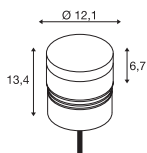

Tête de lampe orientable à 180°
220-240V ~50/60Hz | 500mA
Puissance totale : 10W
Matière : aluminium



Down 750lm | 2700K

Coloris	Ref.	CHF
● anthracite	1007232	● 333.50



Article	Ref.	CHF
Borne		
● anthracite		
H : 23,4 cm	1006379	119.00
● anthracite		
H : 53,4 cm	1006380	169.00
● anthracite		
H : 83,4 cm	1006381	205.00
Ancrage au sol		
● inox	1006382	59.90
Boîtier de connexion en T		
● noir	228726	33.00
Boîte de connexion IP68, 3 pôles		
● noir	228730	21.30

M-POL S
Tête de lampe 360°,
anti-éblouissement, DALI

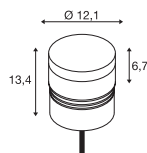

Tête de lampe orientable à 360°
220-240V ~50/60Hz | 500mA
Puissance totale : 10W
Matière : aluminium



Down 750lm | 2700K

Coloris	Ref.	CHF
● anthracite	1007233	● 356.50



Article	Ref.	CHF
Borne		
● anthracite		
H : 23,4 cm	1006379	119.00
● anthracite		
H : 53,4 cm	1006380	169.00
● anthracite		
H : 83,4 cm	1006381	205.00
Ancrage au sol		
● inox	1006382	59.90
Boîte de connexion		
● noir	228725	21.30
Boîte de connexion IP68, 5 pôles		
● noir	1006453	● 41.90

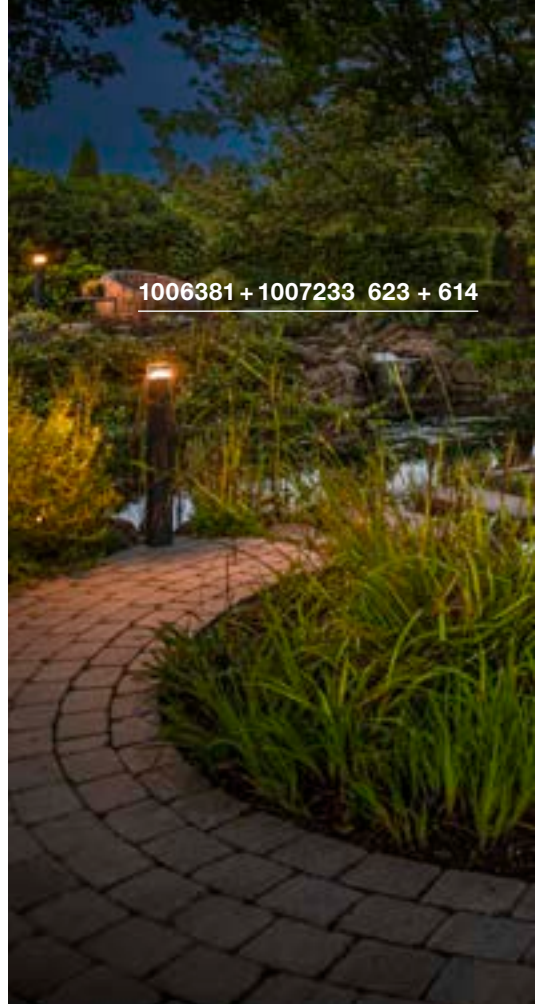

1006381 + 1007233 623 + 614



1006380 + 1007232 623 + 614



1006380 + 1007235 623 + 615



M-POL S
Tête de lampe 180°,
anti-éblouissement

M-POL S
Tête de lampe 180°,
anti-éblouissement, DALI

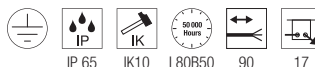
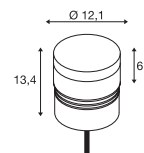
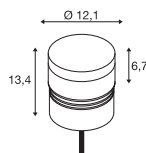

Tête de lampe orientable à 180°
220-240V ~50/60Hz | 500mA
Puissance totale : 10W
Matière : aluminium

Tête de lampe orientable à 180°
220-240V ~50/60Hz | 500mA
Puissance totale : 10W
Matière : aluminium



Down 700lm | 2700K

Down 700lm | 2700K

Coloris	Ref.	CHF
● anthracite	1007234	● 343.90

Coloris	Ref.	CHF
● anthracite	1007235	● 366.90



Article	Ref.	CHF
Borne		
● anthracite H : 23,4 cm	1006379	119.00
● anthracite H : 53,4 cm	1006380	169.00
● anthracite H : 83,4 cm	1006381	205.00
Ancrage au sol		
● inox	1006382	59.90
Boîtier de connexion en T		
● noir	228726	33.00
Boîte de connexion IP68, 3 pôles		
● noir	228730	21.30

Article	Ref.	CHF
Borne		
● anthracite H : 23,4 cm	1006379	119.00
● anthracite H : 53,4 cm	1006380	169.00
● anthracite H : 83,4 cm	1006381	205.00
Ancrage au sol		
● inox	1006382	59.90
Boîte de connexion		
● noir	228725	21.30
Boîte de connexion IP68, 5 pôles		
● noir	1006453	● 41.90



1006381 + 1006389 623 + 617



1006381 + 1006393 623 + 617

M-POL S Tête de lampe

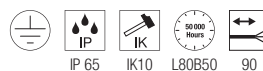
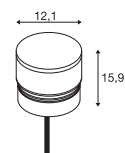

Optique : diffusante
220-240V ~50/60Hz | 500mA
Puissance totale : 9W
Puissance totale : 11W
Matière : aluminium



Down 470lm | 2700K | 510lm | 3000K

Coloris	Ref.	CHF
● anthracite	1006383	315.00



Article	Ref.	CHF
Borne		
● anthracite H : 23,4 cm	1006379	119.00
● anthracite H : 53,4 cm	1006380	169.00
● anthracite H : 83,4 cm	1006381	205.00
Ancrage au sol		
● inox	1006382	59.90
Boîtier de connexion en T		
● noir	228726	33.00
Boîte de connexion IP68, 3 pôles		
● noir	228730	21.30



M-POL S Tête de lampe, DALI

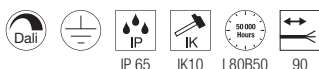
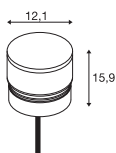

Optique : diffusante
220-240V ~50/60Hz | 500mA
Puissance consommée : 17W
Puissance totale : 19W
Matière : aluminium



Down 890lm | 2700K | 950lm | 3000K

Coloris	Ref.	CHF
● anthracite	1006389	442.00

Article	Ref.	CHF
Borne		
● anthracite H : 23,4 cm	1006379	119.00
● anthracite H : 53,4 cm	1006380	169.00
● anthracite H : 83,4 cm	1006381	205.00
Ancrage au sol		
● inox	1006382	59.90
Boîte de connexion		
● noir	228725	21.30
Boîte de connexion IP68, 5 pôles		
● noir	1006453	41.90

M-POL S Tête de lampe, Shader

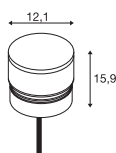

Optique : diffusante avec cache directionnel
220-240V ~50/60Hz | 500mA
Puissance totale : 9W
Puissance totale : 11W
Matière : aluminium



Down 285lm | 2700K | 310lm | 3000K

Coloris	Ref.	CHF
● anthracite	1006387	339.00

Article	Ref.	CHF
Borne		
● anthracite H : 23,4 cm	1006379	119.00
● anthracite H : 53,4 cm	1006380	169.00
● anthracite H : 83,4 cm	1006381	205.00
Ancrage au sol		
● inox	1006382	59.90
Boîtier de connexion en T		
● noir	228726	33.00
Boîte de connexion IP68, 3 pôles		
● noir	228730	21.30

M-POL S Tête de lampe, Shader, DALI

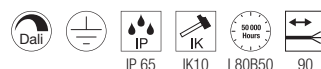
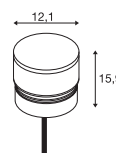

Optique : diffusante avec cache directionnel
220-240V ~50/60Hz | 500mA
Puissance consommée : 17W
Puissance totale : 19W
Matière : aluminium



Down 520lm | 2700K | 550lm | 3000K

Coloris	Ref.	CHF
● anthracite	1006393	469.00

Article	Ref.	CHF
Borne		
● anthracite H : 23,4 cm	1006379	119.00
● anthracite H : 53,4 cm	1006380	169.00
● anthracite H : 83,4 cm	1006381	205.00
Ancrage au sol		
● inox	1006382	59.90
Boîte de connexion		
● noir	228725	21.30
Boîte de connexion IP68, 5 pôles		
● noir	1006453	41.90

M-POL S
Tête de lampe, Louver

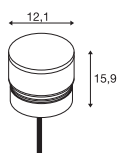

Optique : grille anti-éblouissement
220-240V ~50/60Hz | 500mA
Puissance totale : 9W
Puissance totale : 11W
Matière : aluminium



Down 145lm | 2700K 155lm | 3000K

Coloris	Ref.	CHF
● anthracite	1006385	382.00



Article	Ref.	CHF
Borne		
● anthracite H : 23,4 cm	1006379	119.00
● anthracite H : 53,4 cm	1006380	169.00
● anthracite H : 83,4 cm	1006381	205.00
Ancrage au sol		
● inox	1006382	59.90
Boîtier de connexion en T		
● noir	228726	33.00
Boîte de connexion IP68, 3 pôles		
● noir	228730	21.30

M-POL S
Tête de lampe, Louver, DALI

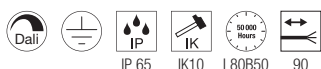
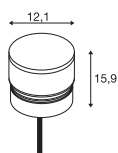

Optique : grille anti-éblouissement
220-240V ~50/60Hz | 500mA
Puissance consommée : 17W
Puissance totale : 19W
Matière : aluminium



Down 260lm | 2700K 270lm | 3000K

Coloris	Ref.	CHF
● anthracite	1006391	539.00



Article	Ref.	CHF
Borne		
● anthracite H : 23,4 cm	1006379	119.00
● anthracite H : 53,4 cm	1006380	169.00
● anthracite H : 83,4 cm	1006381	205.00
Ancrage au sol		
● inox	1006382	59.90
Boîte de connexion		
● noir	228725	21.30
Boîte de connexion IP68, 5 pôles		
● noir	1006453	41.90



1006381 + 1006391 623 + 618



1006381 + 1006388 623 + 619

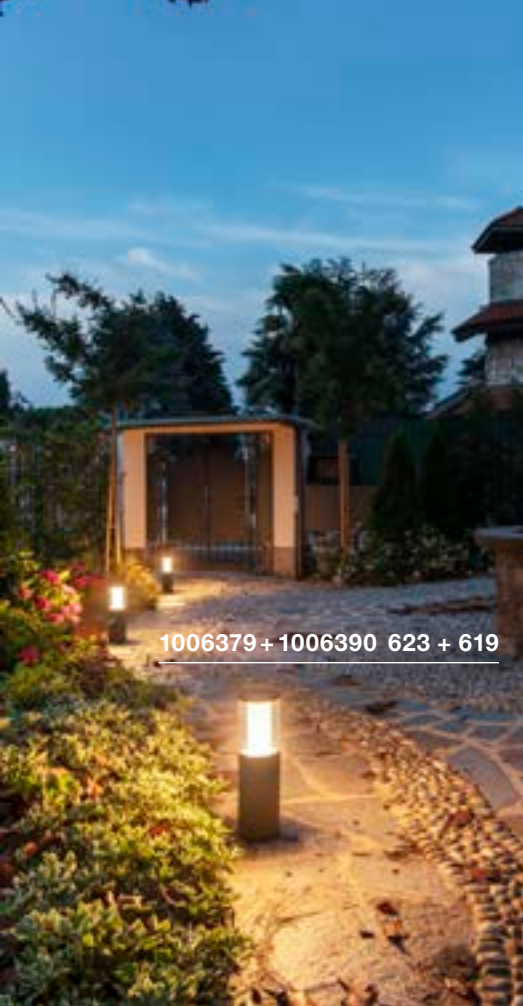

1006379 + 1006390 623 + 619



1006379 + 1006384 623 + 619

M-POL M Tête de lampe

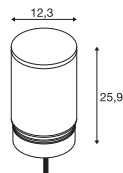

Optique : diffusante
220-240V ~50/60Hz | 500mA
Puissance totale : 9W
Puissance totale : 11W
Matière : aluminium



Down 590lm | 2700K | 660lm | 3000K

Coloris	Ref.	CHF
● anthracite	1006384	339.00



Article	Ref.	CHF
Borne		
● anthracite		
H : 23,4 cm	1006379	119.00
● anthracite		
H : 53,4 cm	1006380	169.00
● anthracite		
H : 83,4 cm	1006381	205.00
Ancrage au sol		
● inox	1006382	59.90
Boîtier de connexion en T		
● noir	228726	33.00
Boîte de connexion IP68, 3 pôles		
● noir	228730	21.30

M-POL M Tête de lampe, DALI

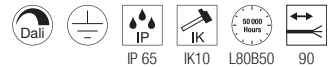
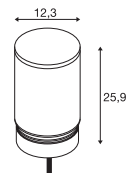

Optique : diffusante
220-240V ~50/60Hz | 500mA
Puissance consommée : 17W
Puissance totale : 19W
Matière : aluminium



Down 1150lm | 2700K | 1230lm | 3000K

Coloris	Ref.	CHF
● anthracite	1006390	469.00



Article	Ref.	CHF
Borne		
● anthracite		
H : 23,4 cm	1006379	119.00
● anthracite		
H : 53,4 cm	1006380	169.00
● anthracite		
H : 83,4 cm	1006381	205.00
Ancrage au sol		
● inox	1006382	59.90
Boîte de connexion		
● noir	228725	21.30
Boîte de connexion IP68, 5 pôles		
● noir	1006453	41.90



M-POL M Tête de lampe, Shader

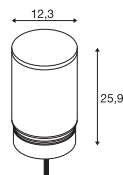

Optique : diffusante avec cache directionnel
220-240V ~50/60Hz | 500mA
Puissance totale : 9W
Puissance totale : 11W
Matière : aluminium



Down 420lm | 2700K | 460lm | 3000K

Coloris	Ref.	CHF
● anthracite	1006388	359.00



Article	Ref.	CHF
Borne		
● anthracite H : 23,4 cm	1006379	119.00
● anthracite H : 53,4 cm	1006380	169.00
● anthracite H : 83,4 cm	1006381	205.00
Ancrage au sol		
● inox	1006382	59.90
Boîtier de connexion en T		
● noir	228726	33.00
Boîte de connexion IP68, 3 pôles		
● noir	228730	21.30

M-POL M Tête de lampe, Shader, DALI

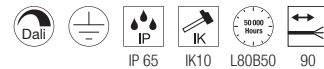
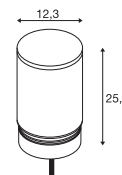

Optique : diffusante avec cache directionnel
220-240V ~50/60Hz | 500mA
Puissance consommée : 17W
Puissance totale : 19W
Matière : aluminium



Down 820lm | 2700K | 870lm | 3000K

Coloris	Ref.	CHF
● anthracite	1006394	492.00



Article	Ref.	CHF
Borne		
● anthracite H : 23,4 cm	1006379	119.00
● anthracite H : 53,4 cm	1006380	169.00
● anthracite H : 83,4 cm	1006381	205.00
Ancrage au sol		
● inox	1006382	59.90
Boîte de connexion		
● noir	228725	21.30
Boîte de connexion IP68, 5 pôles		
● noir	1006453	41.90

1006381 + 1006388 623 + 620



M-POL M

Tête de lampe, Louver

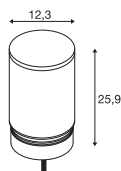

Optique : grille asymétrique
220-240V ~50/60Hz | 500mA
Puissance totale : 9W
Puissance totale : 11W
Matière : aluminium



Down 190lm | 2700K | 210lm | 3000K

Coloris	Ref.	CHF
● anthracite	1006386	529.00



Article	Ref.	CHF
Borne		
● anthracite H : 23,4 cm	1006379	119.00
● anthracite H : 53,4 cm	1006380	169.00
● anthracite H : 83,4 cm	1006381	205.00
Ancrage au sol		
● inox	1006382	59.90
Boîtier de connexion en T		
● noir	228726	33.00
Boîte de connexion IP68, 3 pôles		
● noir	228730	21.30

M-POL M

Tête de lampe, Louver, DALI

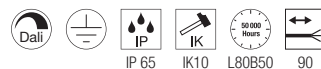
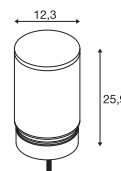

Optique : grille asymétrique
220-240V ~50/60Hz | 500mA
Puissance consommée : 17W
Puissance totale : 19W
Matière : aluminium



Down 350lm | 2700K | 370lm | 3000K

Coloris	Ref.	CHF
● anthracite	1006392	639.00



Article	Ref.	CHF
Borne		
● anthracite H : 23,4 cm	1006379	119.00
● anthracite H : 53,4 cm	1006380	169.00
● anthracite H : 83,4 cm	1006381	205.00
Ancrage au sol		
● inox	1006382	59.90
Boîte de connexion		
● noir	228725	21.30
Boîte de connexion IP68, 5 pôles		
● noir	1006453	41.90

1006381 + 1006392 623 + 621



[1006380](tel:1006380) + [1006392](tel:1006392) - [623](tel:623) + [621](tel:621)



M-POL 30 Borne

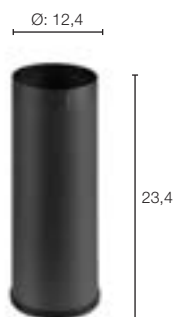

M-POL 60 Borne



M-POL 90 Borne



Matière : aluminium

Coloris	Ref.	CHF
● anthracite	1006379	119.00

Matière : aluminium

Coloris	Ref.	CHF
● anthracite	1006380	169.00

Matière : aluminium

Coloris	Ref.	CHF
● anthracite	1006381	205.00



Article	Ref.	CHF
Boîte de connexion IP68, 5 pôles		
● noir	1006453	41.90
Boîtier de connexion en T		
● noir	228726	33.00
Boîte de connexion IP68, 3 pôles		
● noir	228730	21.30



Article	Ref.	CHF
Boîte de connexion IP68, 5 pôles		
● noir	1006453	41.90
Boîtier de connexion en T		
● noir	228726	33.00
Boîte de connexion IP68, 3 pôles		
● noir	228730	21.30



Article	Ref.	CHF
Boîte de connexion IP68, 5 pôles		
● noir	1006453	41.90
Boîtier de connexion en T		
● noir	228726	33.00
Boîte de connexion IP68, 3 pôles		
● noir	228730	21.30

CONCEVEZ VOTRE SYSTÈME M-POL

Le système modulaire M-POL permet de trouver en quelques étapes la borne lumineuse qui vous convient. Il combine trois hauteurs et huit têtes de lampe avec cinq caractéristiques d'éclairage et deux températures de couleur. Qu'il s'agisse d'une forme haute ou plate, avec les modèles "Diffusor" (optique diffusante) ou "Shader" (optique diffusante avec cache directionnel) pour une lumière homogène et diffuse ou bien sans éblouissement grâce aux diffuseurs "Louver" avec lamelles intégrées. Que ce soit en 2700 ou 3000 kelvins, en version On/Off ou contrôlable par DALI, configurez les bornes d'éclairage M-POL de votre choix et mettez en valeur chaque ambiance extérieure.

SÉLECTIONNEZ LES OPTIONS DE VOTRE CHOIX :

- 1 borne (30, 60, 90)
- 2 gestion tête de lampe (On/off, DALI)
- 3 taille de la tête (haute, plate)
- 4 optique (Clear, Shader, Louver)
- 5 température de couleur (2700K, 3000K)



LE TOUR EST JOUÉ !

TÊTES DE LAMPE

M-POL S

Ø : 12,3 cm, H : 15,9 cm

M-POL M

Ø : 12,3 cm, H : 25,9 cm

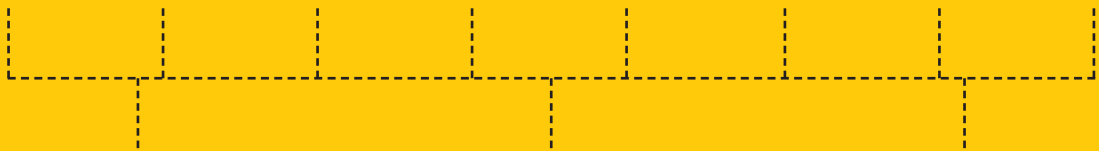
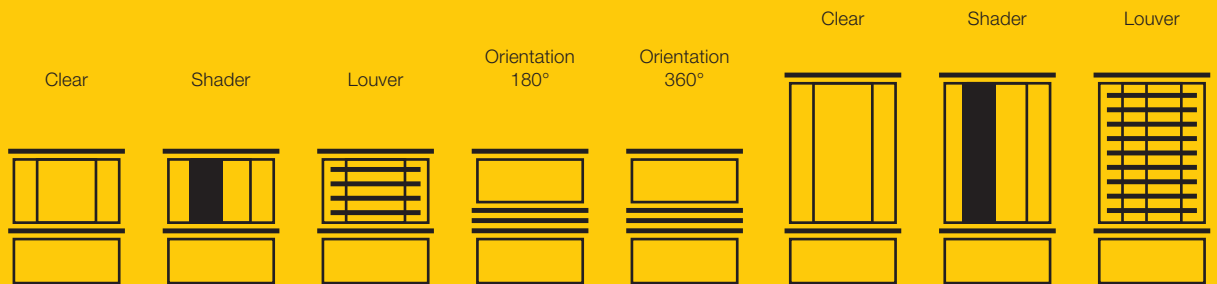

M-POL 30

Ø : 12,4 cm, H : 23,4 cm

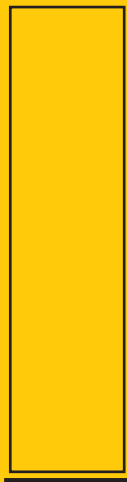

M-POL 60

Ø : 12,4 cm, H : 53,4 cm



M-POL 90

Ø : 12,4 cm, H : 83,4 cm

BORNES



1006408 627



CONCRETO
FL, rond, QPAR 51

CONCRETO
FL, carré, QPAR51

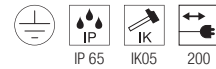
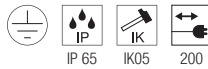
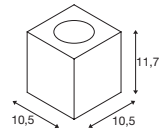
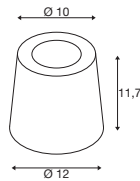

220-240V ~50/60Hz
Matière : béton / aluminium

220-240V ~50/60Hz
Matière : béton / aluminium

• Fiche IP44

• Fiche IP 44



Douille : 1xGU10 Ø max. : 5,1 cm L : 6 cm

Douille : 1xGU10 Ø max. : 5,1 cm L : 6 cm

Coloris	Ref.	CHF
● gris	1006408	145.00

Coloris	Ref.	CHF
● gris	1006409	145.00



LED GU10 51mm | 6W | 38°
2700SK | 450lm | CEE=F
6kWh / 1000h



Ref. : 1005077 | 10.60 CHF



LED GU10 51mm | 6W | 38°
2700SK | 450lm | CEE=F
6kWh / 1000h



Ref. : 1005077 | 10.60 CHF

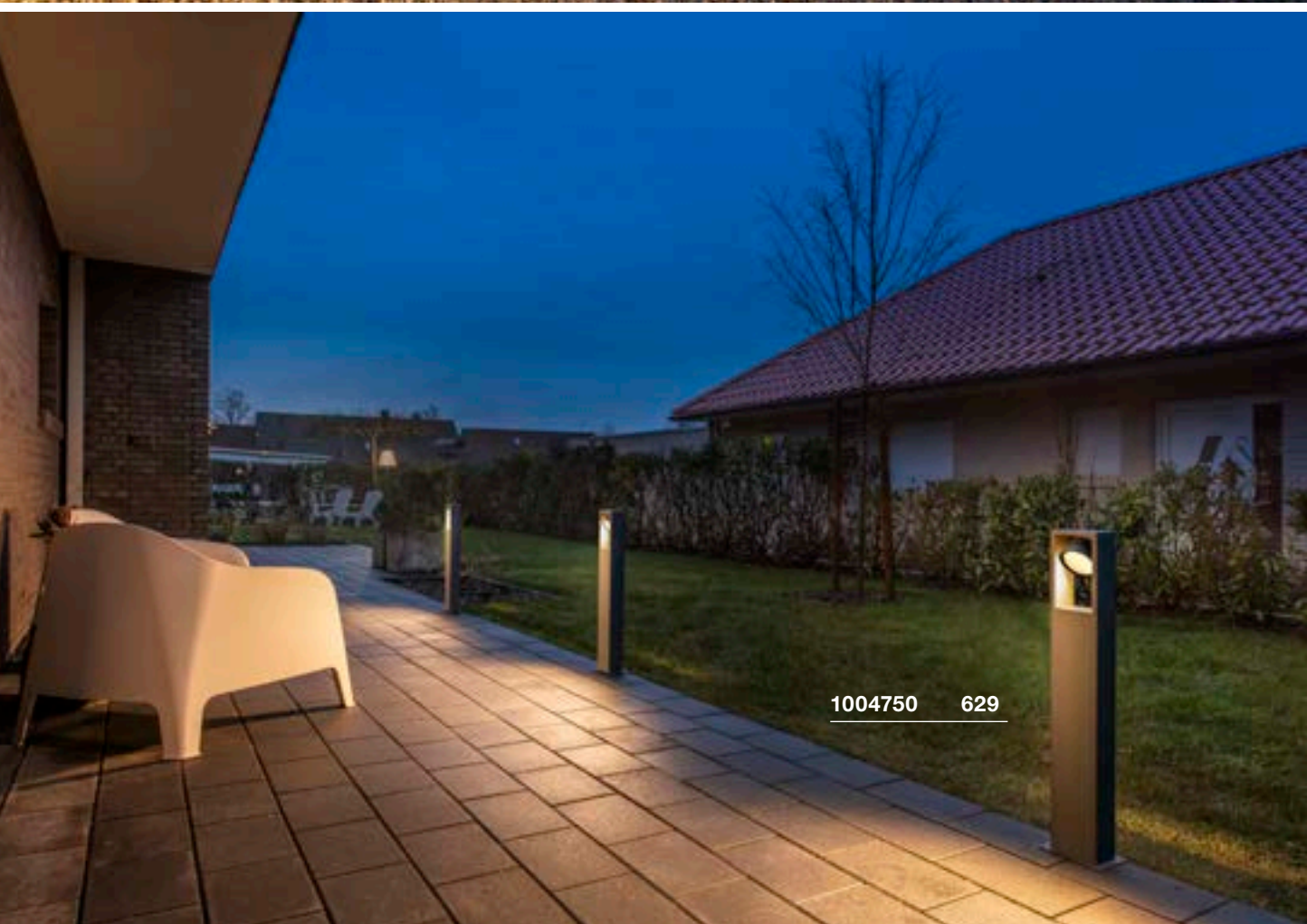



ESKINA FRAME 45

Borne, simple

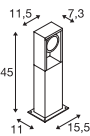

220-240V ~50/60Hz | 350mA
 Puissance totale : 15W
 Matière : aluminium



Down 1100lm | 3000K | 1200lm | 4000K

Coloris	Ref.	CHF
● anthracite	1004749	319.00



Article	Ref.	CHF
Boîte de connexion IP68, 3 pôles		
● noir	228730	21.30

ESKINA FRAME 75

Borne, simple

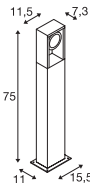

220-240V ~50/60Hz | 350mA
 Puissance totale : 15W
 Matière : aluminium



Down 1100lm | 3000K | 1200lm | 4000K

Coloris	Ref.	CHF
● anthracite	1004750	369.00



Article	Ref.	CHF
Boîte de connexion IP68, 3 pôles		
● noir	228730	21.30

ESKINA FRAME 75

Borne, double

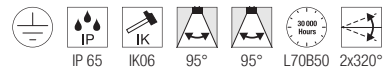
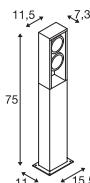

220-240V ~50/60Hz | 700mA
 Puissance totale : 27W
 Matière : aluminium



Spot 1 1100lm | 3000K | 1200lm | 4000K
 Spot 2 1100lm | 3000K | 1200lm | 4000K

Coloris	Ref.	CHF
● anthracite	1004751	390.00



Article	Ref.	CHF
Boîte de connexion IP68, 3 pôles		
● noir	228730	21.30

ESKINA FRAME 125

Borne, double

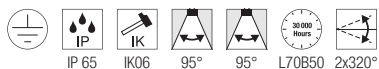
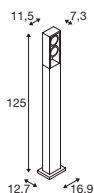

220-240V ~50/60Hz | 700mA
Puissance totale : 27W
Matière : aluminium



Spot 1	1100lm	3000K	1200lm	4000K
Spot 2	1100lm	3000K	1200lm	4000K

Coloris	Ref.	CHF
● anthracite	1005439	469.00



Article	Ref.	CHF
Boîte de connexion IP68, 3 pôles		
● noir	228730	21.30

ESKINA FRAME 175

Borne, double

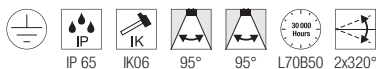
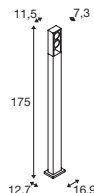

220-240V ~50/60Hz | 700mA
Puissance totale : 27W
Matière : aluminium



Spot 1	1100lm	3000K	1200lm	4000K
Spot 2	1100lm	3000K	1200lm	4000K

Coloris	Ref.	CHF
● anthracite	1005440	539.00



Article	Ref.	CHF
Boîte de connexion IP68, 3 pôles		
● noir	228730	21.30

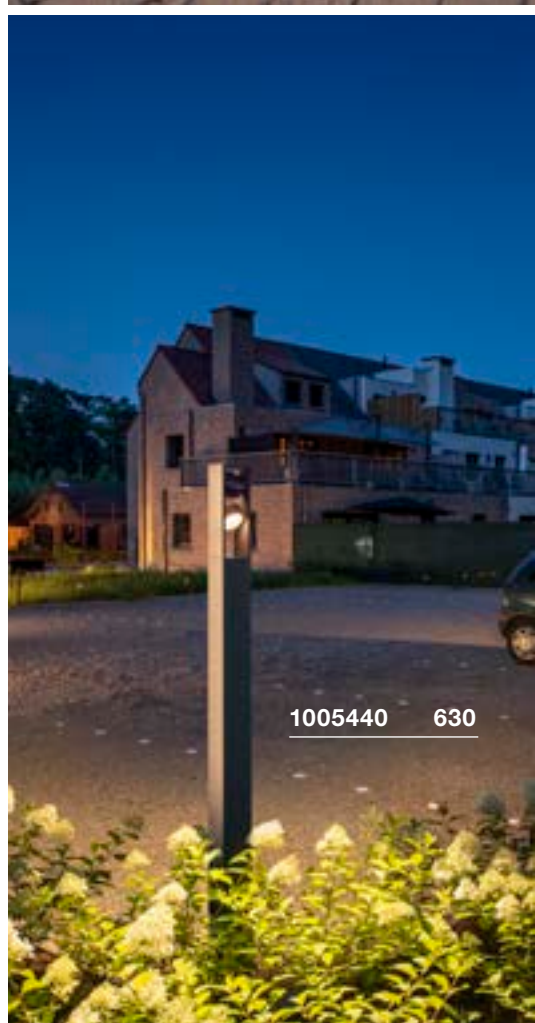
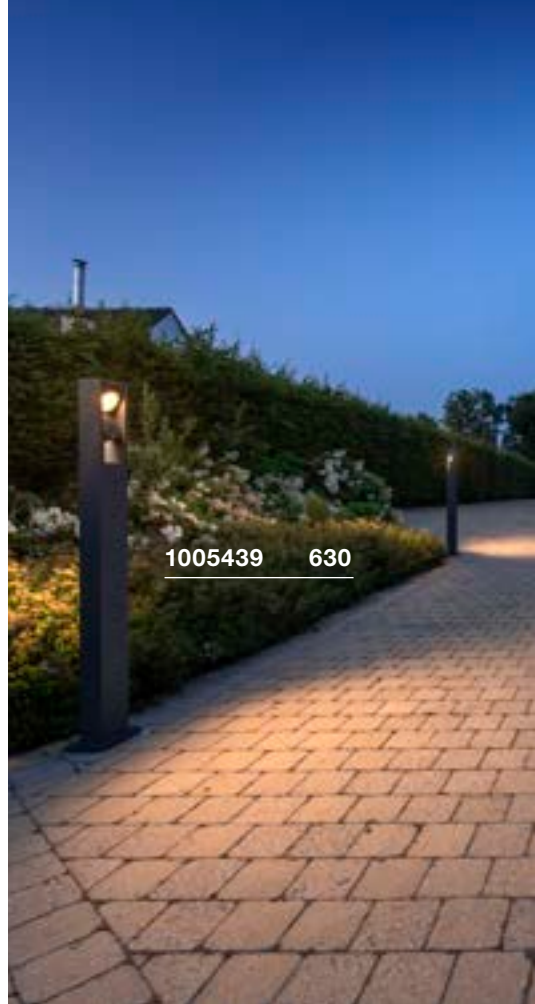

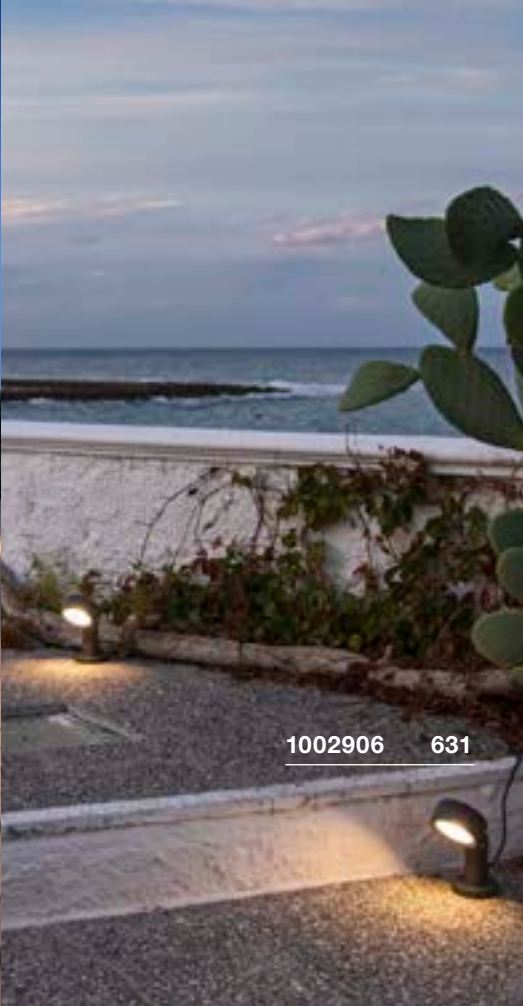

1002906 631



1002907 631

ESKINA 30 Borne

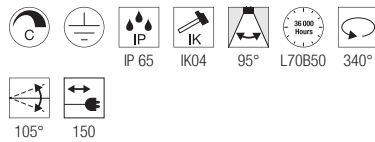
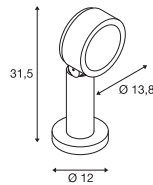

220-240V ~50/60Hz | 350mA
Puissance totale : 14,5W
Matière : aluminium

• Fiche IP44



Down 1000lm | 3000K | 4000K

Coloris	Ref.	CHF
● anthracite	1002906	339.00



Article	Ref.	CHF
Piquet		
● gris	230060	64.00

ESKINA 80 Borne

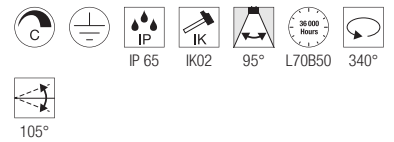
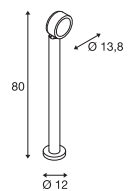

220-240V ~50/60Hz | 350mA
Puissance totale : 14,5W
Matière : aluminium



Down 1000lm | 3000K | 4000K

Coloris	Ref.	CHF
● anthracite	1002907	359.00



Article	Ref.	CHF
Piquet		
● gris	230060	64.00
Boîte de connexion IP68, 3 pôles		
● noir	228730	21.30



232115

633

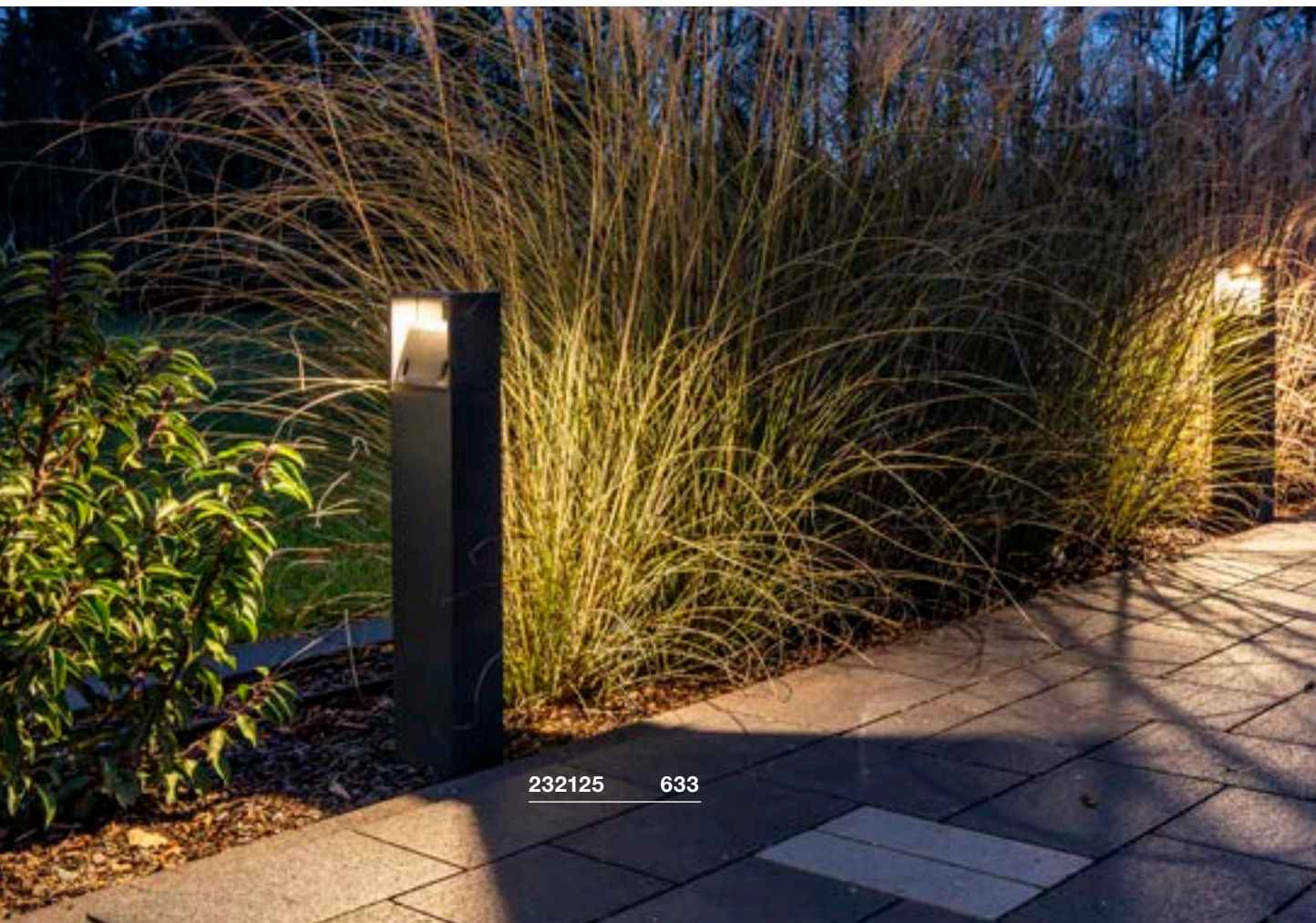

232125

633

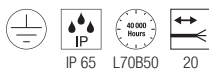
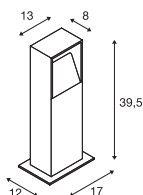
LOGS 40
Borne

220-240V ~50/60Hz | 500mA
Puissance totale : 9,5W
Matière : aluminium

- Câble nu



Down 570lm | 3000K

Coloris	Ref.	CHF
● anthracite	232115	339.00

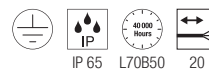
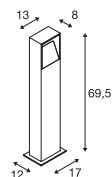

Article	Ref.	CHF
Accessoires de fixation pour béton		
● gris	232119	78.00
Piquet		
● gris	231230	55.00
Kit de fixation		
● inox	228754	5.25
Boîte de connexion IP68, 3 pôles		
● noir	228730	21.30

LOGS 70
Borne

220-240V ~50/60Hz | 500mA
Puissance totale : 9,5W
Matière : aluminium

- Câble nu



Down 570lm | 3000K

Coloris	Ref.	CHF
● anthracite	232125	419.00



Article	Ref.	CHF
Accessoires de fixation pour béton		
● gris	232119	78.00
Piquet		
● gris	231230	55.00
Kit de fixation		
● inox	228754	5.25
Boîte de connexion IP68, 3 pôles		
● noir	228730	21.30

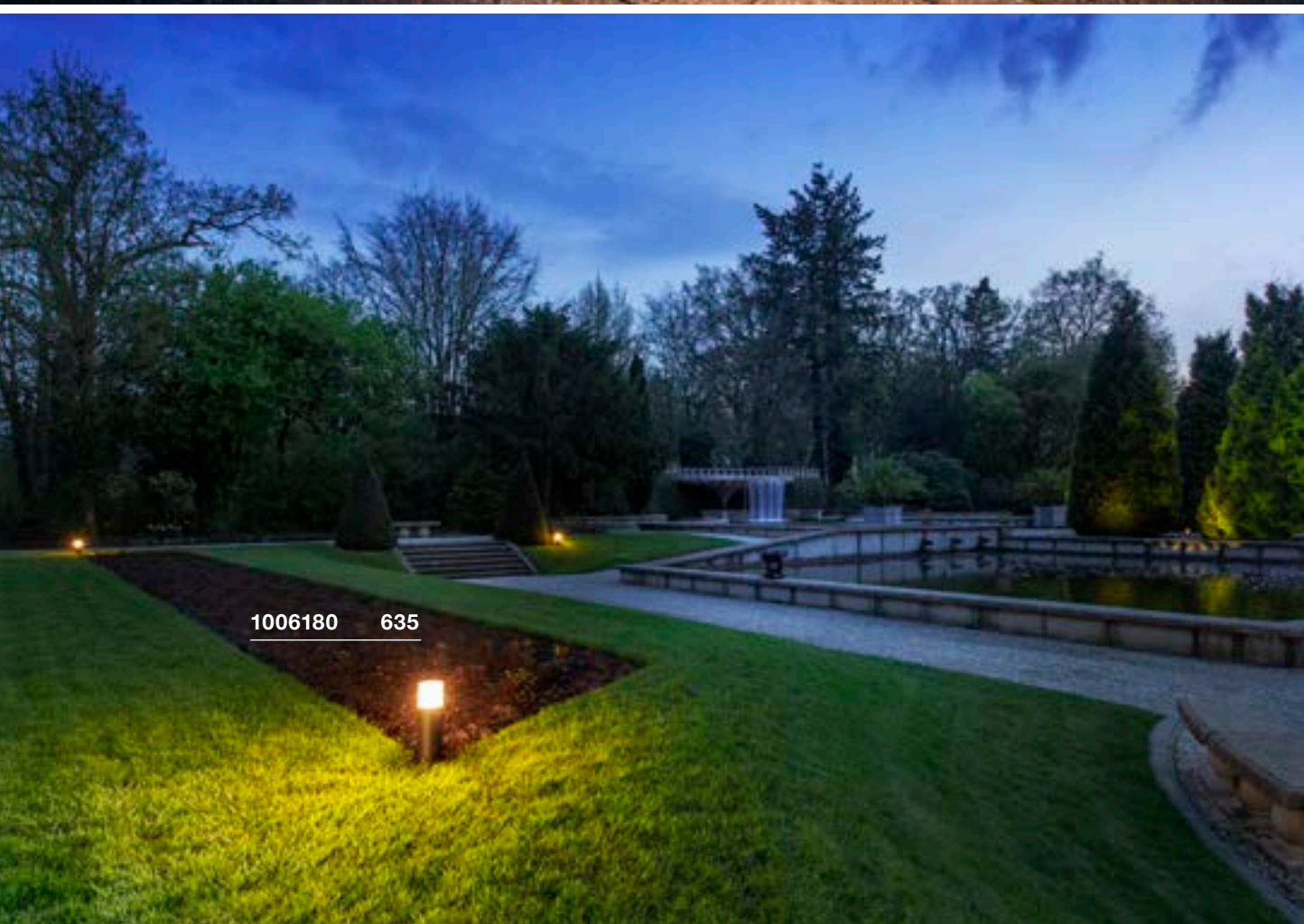



GRAFIT 30
Borne, ronde, E27

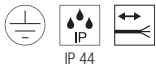
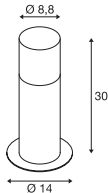

220-240V ~50/60Hz
Matière : aluminium / acrylique

- Câble nu



Douille : 1xE27 Ø max. : 6 cm L : 11,5 cm

Coloris	Ref.	CHF
● anthracite	1006180	102.00

LED E27 | 8W | 240°
3000SK | 880lm | CEE=E
8kWh / 1000h

Ref. : 1005289 | 12.90 CHF

⊕

Article	Ref.	CHF
Boîte de connexion IP68, 3 pôles		
● noir	228730	21.30

GRAFIT 60
Borne, ronde, E27

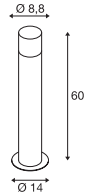

220-240V ~50/60Hz
Matière : aluminium / acrylique

- Câble nu



Douille : 1xE27 Ø max. : 6 cm L : 11,5 cm

Coloris	Ref.	CHF
● anthracite	1006181	132.00

LED E27 | 8W | 240°
3000SK | 880lm | CEE=E
8kWh / 1000h

Ref. : 1005289 | 12.90 CHF

⊕

Article	Ref.	CHF
Boîte de connexion IP68, 3 pôles		
● noir	228730	21.30

GRAFIT 90
Borne, ronde, E27

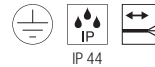
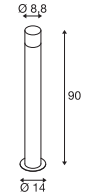

220-240V ~50/60Hz
Matière : aluminium / acrylique

- Câble nu



Douille : 1xE27 Ø max. : 6 cm L : 11,5 cm

Coloris	Ref.	CHF
● anthracite	1006182	155.00

LED E27 | 8W | 240°
3000SK | 880lm | CEE=E
8kWh / 1000h

Ref. : 1005289 | 12.90 CHF

⊕

Article	Ref.	CHF
Boîte de connexion IP68, 3 pôles		
● noir	228730	21.30



231225 637



1006184 637



GRAFIT 30

Borne, E27

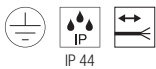
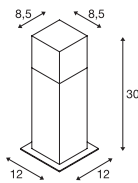

220-240V ~50/60Hz
Matière : aluminium / plastique

- Câble nu



Douille : 1xE27 Ø max. : 6 cm L : 11,5 cm

Coloris	Ref.	CHF
● anthracite	231215	99.00



LED E27 | 8W | 240°
3000SK | 880lm | CEE=E
8kWh / 1000h



Ref. : 1005289 | 12.90 CHF



Article	Ref.	CHF
Piquet		
● gris	231230	55.00
Kit de fixation		
● inox	228754	5.25
Boîte de connexion IP68, 3 pôles		
● noir	228730	21.30

GRAFIT 60

Borne, E27

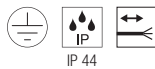
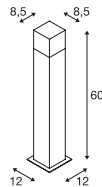

220-240V ~50/60Hz
Matière : aluminium / plastique

- Câble nu



Douille : 1xE27 Ø max. : 6 cm L : 11,5 cm

Coloris	Ref.	CHF
● anthracite	231225	138.00



LED E27 | 8W | 240°
3000SK | 880lm | CEE=E
8kWh / 1000h



Ref. : 1005289 | 12.90 CHF



Article	Ref.	CHF
Piquet		
● gris	231230	55.00
Kit de fixation		
● inox	228754	5.25
Boîte de connexion IP68, 3 pôles		
● noir	228730	21.30

GRAFIT 90

Borne, E27

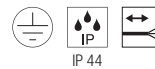
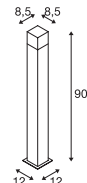

220-240V ~50/60Hz
Matière : aluminium / acrylique

- Câble nu



Douille : 1xE27 Ø max. : 6 cm L : 11,5 cm

Coloris	Ref.	CHF
● anthracite	1006184	155.00



LED E27 | 8W | 240°
3000SK | 880lm | CEE=E
8kWh / 1000h



Ref. : 1005289 | 12.90 CHF



Article	Ref.	CHF
Piquet		
● gris	231230	55.00
Boîte de connexion IP68, 3 pôles		
● noir	228730	21.30



1005442 639



QUADRULO FL

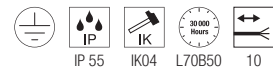
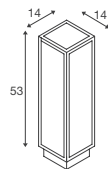

100-277V ~50/60Hz | 480mA
 Puissance totale : 7W
 Matière : aluminium / acrylique

- Boîtier de raccordement IP



Down

340lm | 3000K

Coloris	Ref.	CHF
● anthracite	1005442	209.00

RUSTY® SLOT 50
Borne

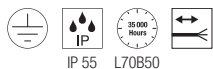
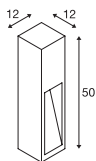

220-240V ~50/60Hz
Puissance totale : 9W
Matière : acier FeCSi / polycarbonate (PC)

- Câble nu



Down 30lm | 3000K

Coloris	Ref.	CHF
● rouille	233447	439.00



Article	Ref.	CHF
Piquet		
● gris	231230	55.00
Boîte de connexion IP68, 3 pôles		
● noir	228730	21.30

RUSTY® SLOT 80
Borne

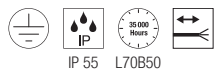
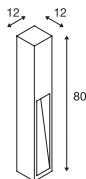

220-240V ~50/60Hz
Puissance totale : 9W
Matière : acier FeCSi / polycarbonate (PC)

- Câble nu



Down 30lm | 3000K

Coloris	Ref.	CHF
● rouille	233457	579.00



Article	Ref.	CHF
Piquet		
● gris	231230	55.00
Boîte de connexion IP68, 3 pôles		
● noir	228730	21.30



229410 641

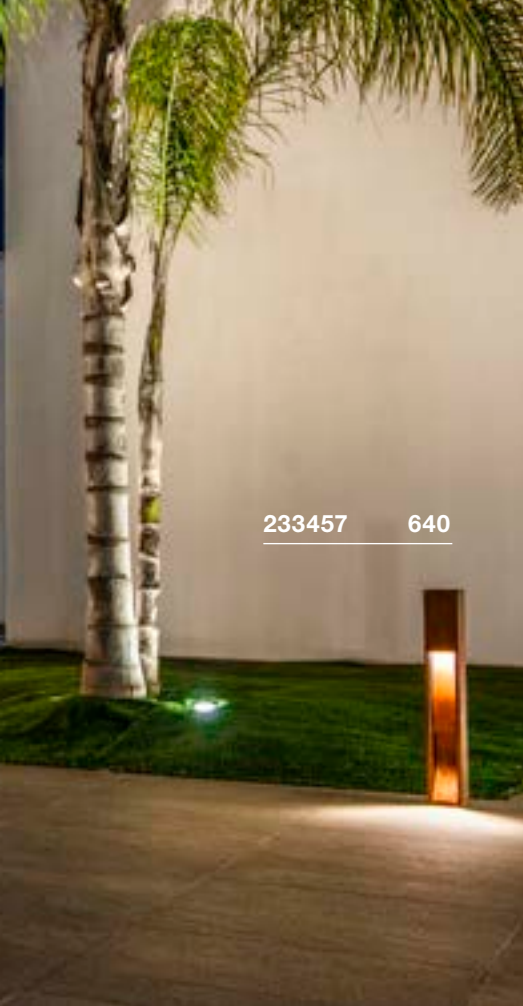

233457 640



229411 641

RUSTY® SLOT 50

Borne, E27

RUSTY® SLOT 80

Borne, E27

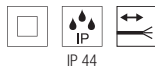
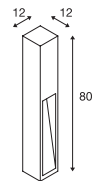
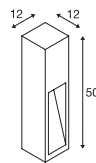

IP 44

220-240V ~50/60Hz
Matière : acier FeCSi / polycarbonate (PC)

- Câble nu

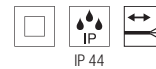

IP 44

220-240V ~50/60Hz
Matière : acier FeCSi / polycarbonate (PC)

- Câble nu



Douille : 1xE27 Ø max. : 4,8 cm L : 13,9 cm

Coloris	Ref.	CHF
● rouille	229410	379.00



LED E27 | 8W | 240°
3000SK | 880lm | CEE=E
8kWh / 1000h



Ref. : 1005289 | 12.90 CHF



Article	Ref.	CHF
Piquet		
● gris	231230	55.00
Boîte de connexion IP68, 3 pôles		
● noir	228730	21.30



Douille : 1xE27 Ø max. : 4,8 cm L : 13,9 cm

Coloris	Ref.	CHF
● rouille	229411	439.00



LED E27 | 8W | 240°
4000SK | 920lm | CEE=E
8kWh / 1000h



Ref. : 1005290 | 12.90 CHF



Article	Ref.	CHF
Piquet		
● gris	231230	55.00
Boîte de connexion IP68, 3 pôles		
● noir	228730	21.30



233090 642



229420 643

RUSTY® PATHLIGHT

Borne, TCR-TSE

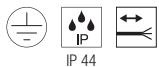
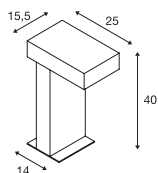

220-240V ~50/60Hz
Matière : acier FeCSi / polycarbonate (PC)

- Câble nu



Douille : 1xGX53 Ø max. : 7,5 cm L : 2,7 cm

Coloris	Ref.	CHF
● rouille	230090	359.00



LED GX53 | 6,1W | 120°
3000SK | 490lm | CEE=G
6kWh / 1000h



Ref. : 1005271 | 13.50 CHF



Article	Ref.	CHF
Piquet		
● gris	229422	55.00
Boîte de connexion IP68, 3 pôles		
● noir	228730	21.30

RUSTY® 40

Borne

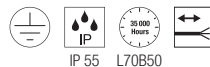
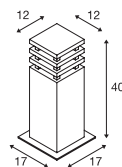

220-240V ~50/60Hz
Puissance totale : 9W
Matière : acier FeCSi / polycarbonate (PC)

- Câble nu



Down 90lm | 3000K

Coloris	Ref.	CHF
● rouille	233427	439.00



Article	Ref.	CHF
Piquet		
● gris	229422	55.00
Boîte de connexion IP68, 3 pôles		
● noir	228730	21.30



RUSTY® 70
Borne

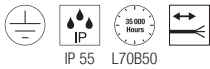
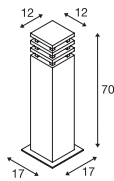

220-240V ~50/60Hz
Puissance totale : 9W
Matière : acier FeCSi / polycarbonate (PC)

- Câble nu



Down 90lm | 3000K

Coloris	Ref.	CHF
rouille	233437	529.00



Article	Ref.	CHF
Piquet		
● gris	229422	55.00
Boîte de connexion IP68, 3 pôles		
● noir	228730	21.30

RUSTY® 40
Borne, E27

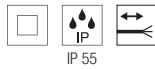
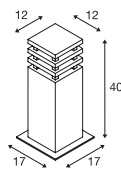

220-240V ~50/60Hz
Matière : acier FeCSi / polycarbonate (PC)

- Câble nu



Douille : 1xE27 Ø max. : 4,8 cm | L : 13,9 cm

Coloris	Ref.	CHF
rouille	229420	379.00



LED E27 | 8W | 240°
3000SK | 880lm | CEE=E
8kWh / 1000h



Ref. : 1005289 | 12.90 CHF



Article	Ref.	CHF
Piquet		
● gris	229422	55.00
Boîte de connexion IP68, 3 pôles		
● noir	228730	21.30

RUSTY® 70
Borne, E27

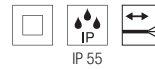
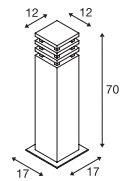

220-240V ~50/60Hz
Matière : acier FeCSi / polycarbonate (PC)

- Câble nu



Douille : 1xE27 Ø max. : 4,8 cm | L : 13,9 cm

Coloris	Ref.	CHF
rouille	229421	449.00



LED E27 | 8W | 240°
4000SK | 920lm | CEE=E
8kWh / 1000h



Ref. : 1005290 | 12.90 CHF



Article	Ref.	CHF
Piquet		
● gris	229422	55.00
Boîte de connexion IP68, 3 pôles		
● noir	228730	21.30

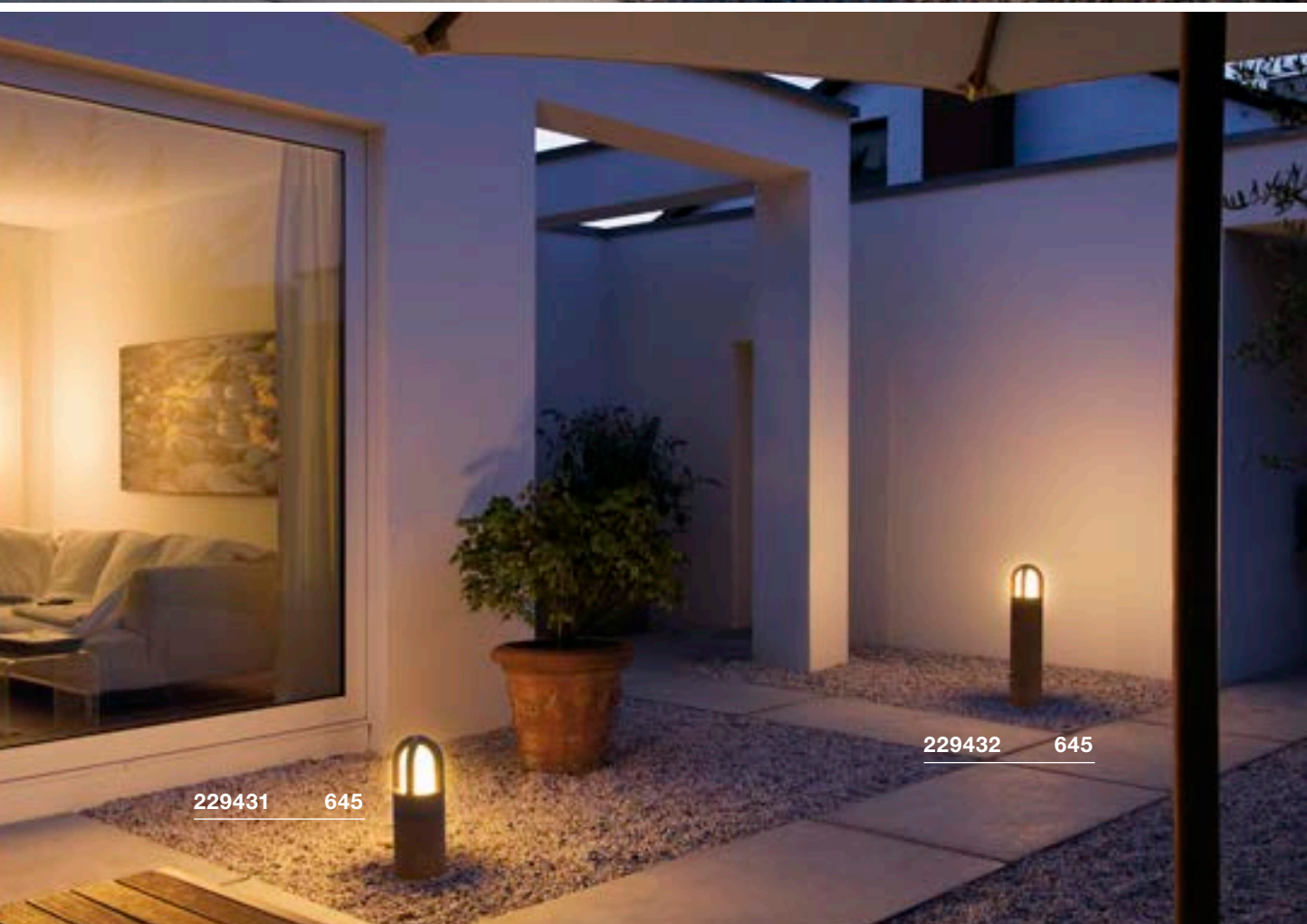



RUSTY® CONE 24 FL, E14

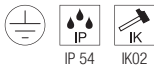
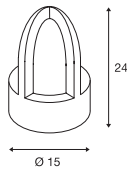

220-240V ~50/60Hz
Matière : acier FeCSi / verre



Douille : 1xE14 Ø max. : 4,8 cm L : 13,9 cm

Coloris	Ref.	CHF
● rouille	229430	289.00



C35 | 4,2W | 320°
2700SK | 350lm | CEE=G
5kWh / 1000h



Ref. : 1005285 | 12.90 CHF

RUSTY® CONE 40 Borne, E27

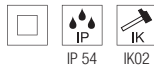
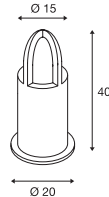

220-240V ~50/60Hz
Matière : acier FeCSi / verre



Douille : 1xE27 Ø max. : 4,8 cm L : 13,9 cm

Coloris	Ref.	CHF
● rouille	229431	509.00



LED E27 | 8W | 240°
3000SK | 880lm | CEE=E
8kWh / 1000h



Ref. : 1005289 | 12.90 CHF



Article	Ref.	CHF
Piquet		
● gris	229422	55.00
Boîte de connexion IP68, 3 pôles		
● noir	228730	21.30

RUSTY® CONE 70 Borne, E27

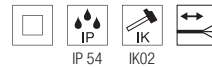
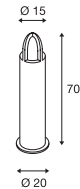

220-240V ~50/60Hz
Matière : acier FeCSi / polycarbonate (PC)



Douille : 1xE27 Ø max. : 4,8 cm L : 13,9 cm

Coloris	Ref.	CHF
● rouille	229432	679.00



LED E27 | 8W | 240°
3000SK | 880lm | CEE=E
8kWh / 1000h



Ref. : 1005289 | 12.90 CHF



Article	Ref.	CHF
Piquet		
● gris	229422	55.00
Boîte de connexion IP68, 3 pôles		
● noir	228730	21.30

RUSTY® 40
Borne, E27

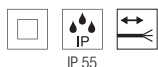
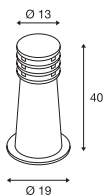

220-240V ~50/60Hz
Matière : acier FeCSI / polycarbonate (PC)

- Câble nu



Douille : 1xE27 Ø max. : 4,8 cm L : 13,9 cm

Coloris	Ref.	CHF
rouille	229020	345.00



LED E27 | 8W | 240°
4000SK | 920lm | CEE=E
8kWh / 1000h



Ref. : 1005290 | 12.90 CHF



Article	Ref.	CHF
Piquet		
● inox	229022	64.00
Boîte de connexion IP68, 3 pôles		
● noir	228730	21.30

RUSTY® 70
Borne, E27

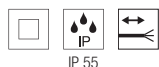
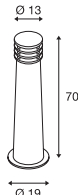

220-240V ~50/60Hz
Matière : acier FeCSI / polycarbonate (PC)

- Câble nu



Douille : 1xE27 Ø max. : 4,8 cm L : 13,9 cm

Coloris	Ref.	CHF
rouille	229021	439.00



LED E27 | 8W | 240°
3000SK | 880lm | CEE=E
8kWh / 1000h



Ref. : 1005289 | 12.90 CHF



Article	Ref.	CHF
Piquet		
● inox	229022	64.00
Boîte de connexion IP68, 3 pôles		
● noir	228730	21.30



229020 646

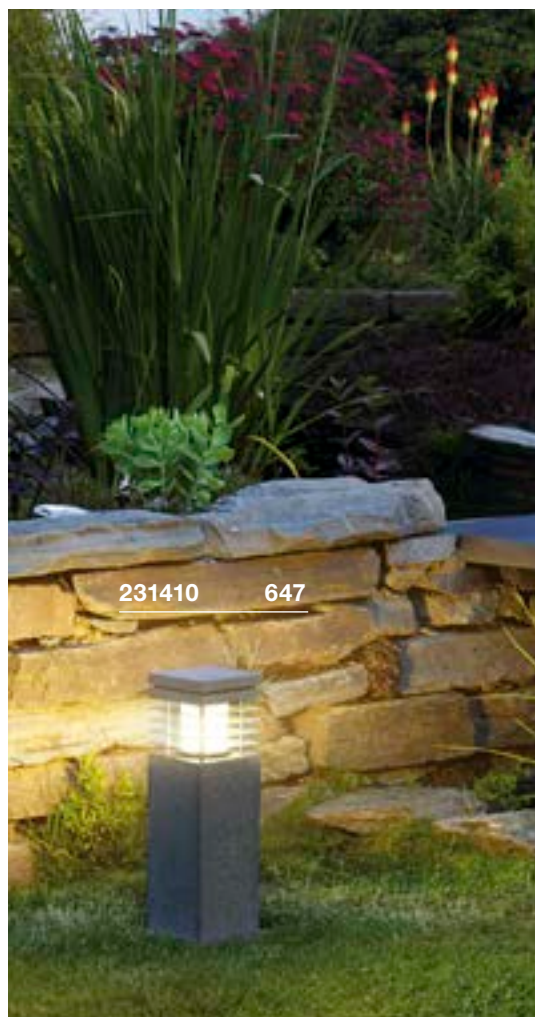

231410 647



229021 646

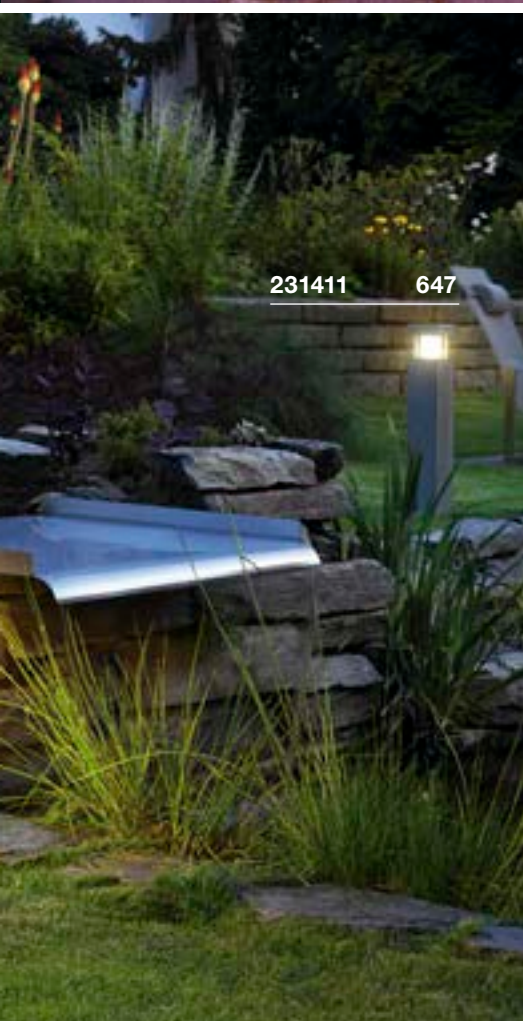

231411 647

ARROCK GRANITE 40

Borne, carré, E27

ARROCK GRANITE 70

Borne, carré, E27

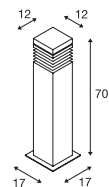
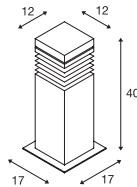

220-240V ~50/60Hz
Matière : granite / acier inoxydable 304



220-240V ~50/60Hz
Matière : granite / acier inoxydable 304



Douille : 1xE27 Ø max. : 5,2 cm L : 11,5 cm



Douille : 1xE27 Ø max. : 5,2 cm L : 11,5 cm

Coloris	Ref.	CHF
● gris	231410	459.00

Coloris	Ref.	CHF
● gris	231411	529.00



LED E27 | 8W | 240°
3000SK | 880lm | CEE=E
8kWh / 1000h



Ref. : 1005289 | 12.90 CHF



LED E27 | 8W | 240°
4000SK | 920lm | CEE=E
8kWh / 1000h



Ref. : 1005290 | 12.90 CHF



Article	Ref.	CHF
Piquet		
● inox	229022	64.00
Boîte de connexion IP68, 3 pôles		
● noir	228730	21.30



Article	Ref.	CHF
Piquet		
● inox	229022	64.00
Boîte de connexion IP68, 3 pôles		
● noir	228730	21.30

ARROCK ARC
Borne, QPAR51

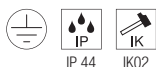
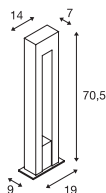

220-240V ~50/60Hz
Matière : granite / acier inoxydable 304



Douille : 1xGU10 Ø max. : 5,1 cm L : 7,6 cm

Coloris	Ref.	CHF
● gris	231420	459.00



LED GU10 51mm | 6W | 38°
2700SK | 450lm | CEE=F
6kWh / 1000h



Ref. : 1005075 | 10.60 CHF



Article	Ref.	CHF
● Piquet ● gris	231233	64.00



231420 648

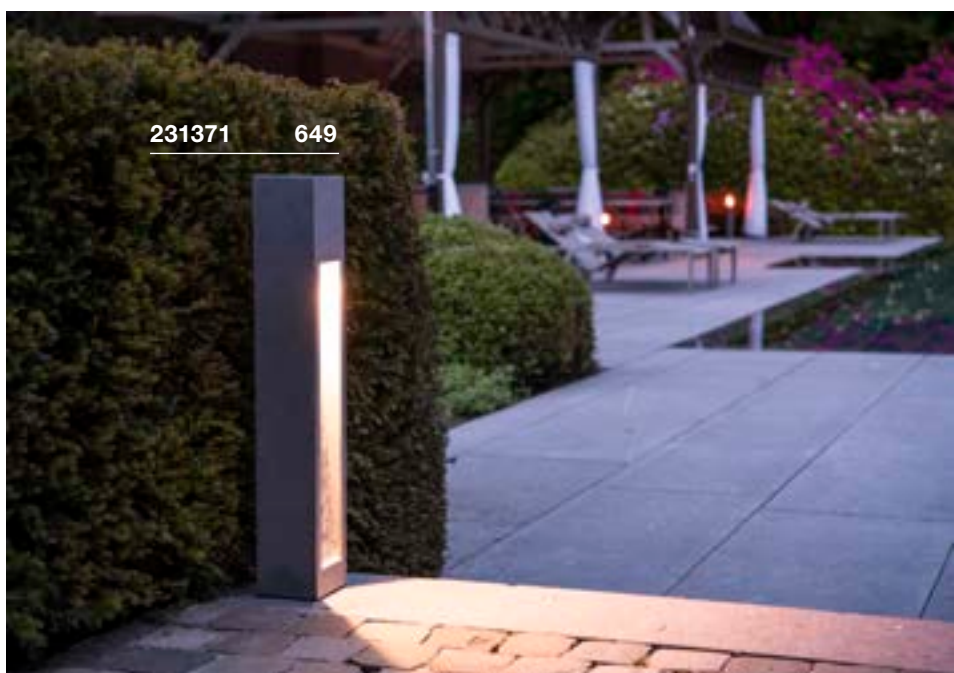

231371 649



231440 649



ARROCK STONE 50

Borne

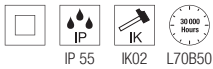
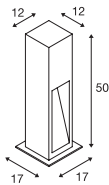

220-240V ~50/60Hz | 700mA
 Puissance totale : 9W
 Matière : basalte / acier inoxydable 304



Down 330lm | 3000K

Coloris	Ref.	CHF
● gris	231370	509.00



Article	Ref.	CHF
Piquet		
● gris	231233	64.00

ARROCK STONE 75

Borne

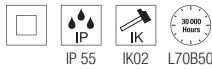
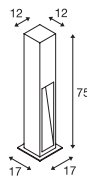

220-240V ~50/60Hz | 700mA
 Puissance totale : 9W
 Matière : basalte / acier inoxydable 304



Down 330lm | 3000K

Coloris	Ref.	CHF
● gris	231371	579.00



Article	Ref.	CHF
Piquet		
● gris	231233	64.00

ARROCK SLOT

Borne, QPAR51

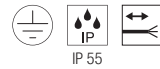
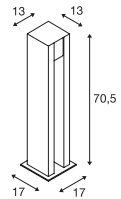

220-240V ~50/60Hz
 Matière : granite / acier inoxydable 304
 • Câble nu



Douille : 1xGU10

Coloris	Ref.	CHF
● gris	231440	509.00



LED GU10 51mm | 6W | 38°
 2700SK | 450lm | CEE=F
 6kWh / 1000h



Ref. : 1005076 | 10.60 CHF



Article	Ref.	CHF
Piquet		
● gris	231235	64.00
Boîte de connexion IP68, 3 pôles		
● noir	228730	21.30



1003535 651

L-LINE OUT 30 FL, vertical

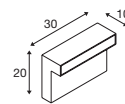

1003538 651



220-240V ~50/60Hz | 500mA
Puissance totale : 11,5W
Matière : aluminium / polycarbonate (PC)

- La température de couleur doit être définie avant l'installation
- Câble nu



IRC
80

Down 800lm | 3000K | 810lm | 4000K

Coloris	Ref.	CHF
● anthracite	1003536	259.00



Article	Ref.	CHF
Boîte de connexion IP68, 3 pôles		
● noir	228730	21.30



L-LINE OUT 60

FL, vertical

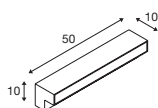

220-240V ~50/60Hz | 500mA
Puissance totale : 11,5W
Matière : aluminium / polycarbonate (PC)

- La température de couleur doit être définie avant l'installation
- Câble nu



Down 780lm | 3000K | 800lm | 4000K

Coloris	Ref.	CHF
● anthracite	1003535	279.00



Article	Ref.	CHF
Boîte de connexion IP68, 3 pôles		
● noir	228730	21.30

L-LINE OUT 50

Borne, horizontal

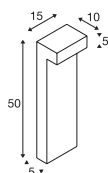

220-240V ~50/60Hz | 350mA
Puissance totale : 7W
Matière : aluminium / polycarbonate (PC)

- La température de couleur doit être définie avant l'installation
- Câble nu



Down 490lm | 3000K | 530lm | 4000K

Coloris	Ref.	CHF
● anthracite	1003537	219.00



Article	Ref.	CHF
Boîte de connexion IP68, 3 pôles		
● noir	228730	21.30

L-LINE OUT 80

Borne, horizontal

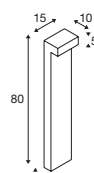

220-240V ~50/60Hz | 350mA
Puissance totale : 7W
Matière : aluminium / polycarbonate (PC)

- La température de couleur doit être définie avant l'installation
- Câble nu



Down 490lm | 3000K | 530lm | 4000K

Coloris	Ref.	CHF
● anthracite	1003538	259.00



Article	Ref.	CHF
Boîte de connexion IP68, 3 pôles		
● noir	228730	21.30

THEO PATHLIGHT

Borne, double

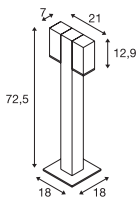

220-240V ~50/60Hz
Matière : aluminium



Douilles : 2xGU10

Coloris	Ref.	CHF
● anthracite	1002871	299.00



LED GU10 51mm | 6W | 38°
2700SK | 450lm | CEE=F
6kWh / 1000h



Ref. : 1005077 | 10.60 CHF



Article	Ref.	CHF
Boîte de connexion IP68, 3 pôles		
● noir	228730	21.30

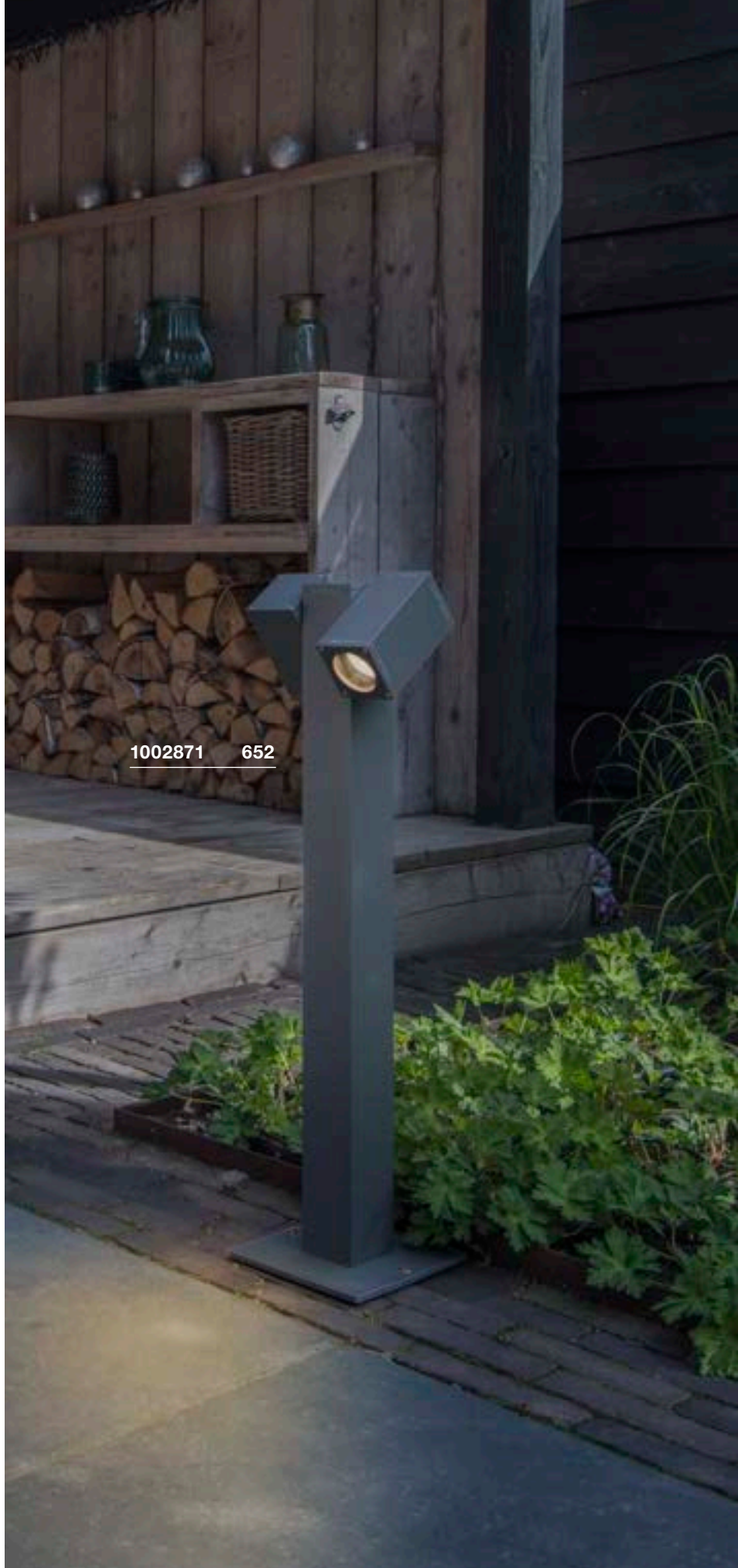

1002871 652



OVALISK 75 Borne

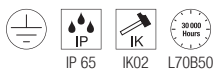
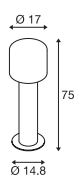

220-240V ~50/60Hz | 500mA
Puissance totale : 9,2W
Matière : aluminium / verre



Down 580lm | 3000K | 630lm | 4000K

Coloris	Ref.	CHF
● anthracite	1004680	359.00



Article	Ref.	CHF
Accessoires de fixation pour béton		
○ argent	228712	79.00
Piquet		
● gris	228722	74.00
Boîte de connexion IP68, 3 pôles		
● noir	228730	21.30

OVALISK 100 Borne

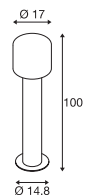

220-240V ~50/60Hz | 500mA
Puissance totale : 9,2W
Matière : aluminium / verre



Down 580lm | 3000K | 630lm | 4000K

Coloris	Ref.	CHF
● anthracite	1004681	390.00

1004680 653



1002000 655

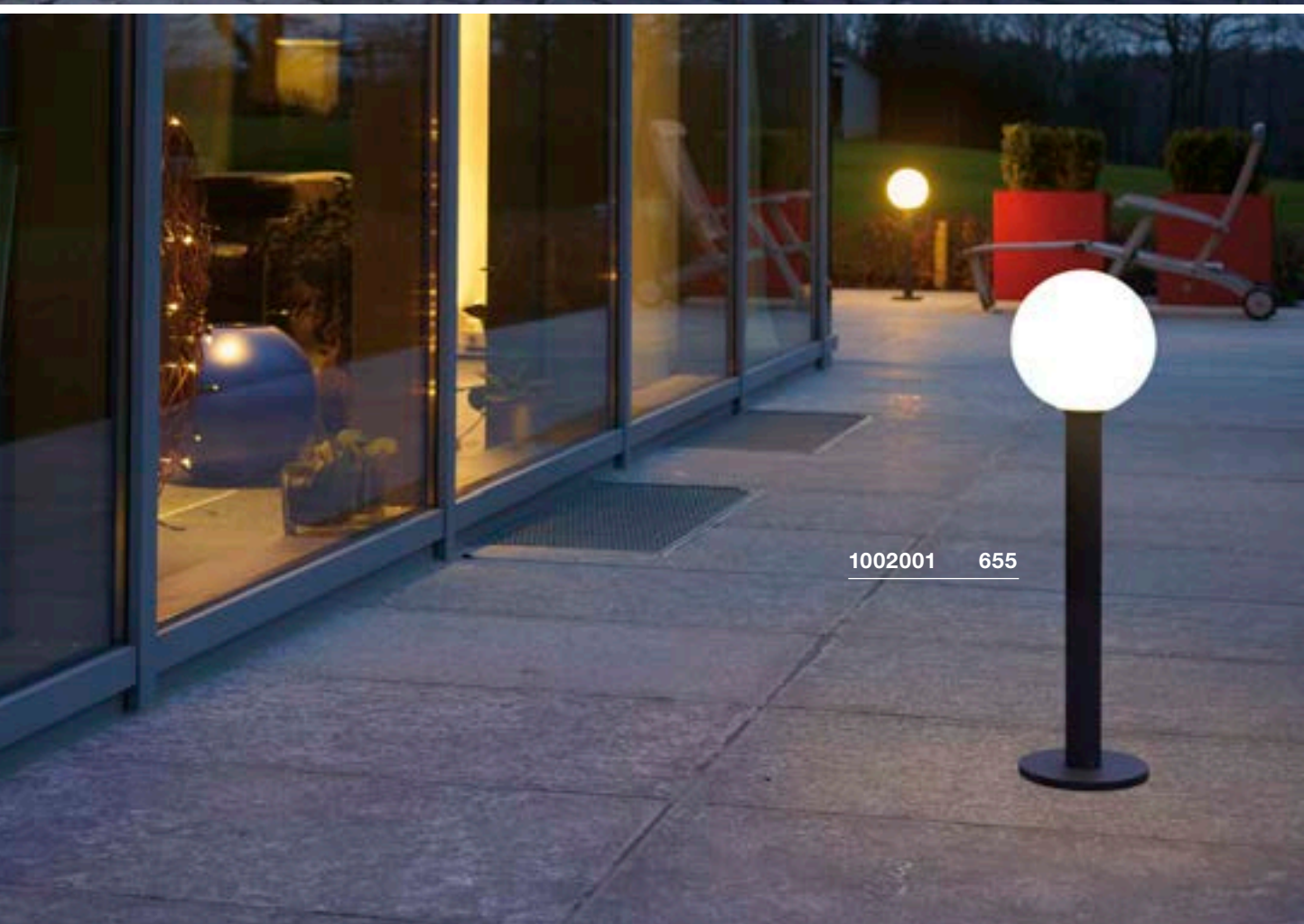

1002001 655



GLOO PURE 27

Borne, E27

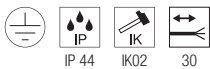
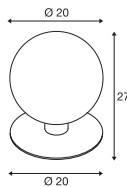

220-240V ~50/60Hz
Matière : aluminium / verre



- Câble nu



Douille : 1xE27 Ø max. : 4,8 cm L : 18 cm

Coloris	Ref.	CHF
● anthracite	1001999	117.00



 | 13,5W | 240°
 3000SK | 1520lm | CEE=E
 14kWh / 1000h
 

Ref. : 1005307 | 13.80 CHF

Article	Ref.	CHF
Piquet		
● gris	231234	64.00
Boîte de connexion IP68, 3 pôles		
● noir	228730	21.30

GLOO PURE 44

Borne, E27

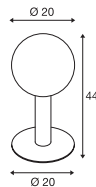

220-240V ~50/60Hz
Matière : aluminium / verre



- Câble nu



Douille : 1xE27 Ø max. : 4,8 cm L : 18 cm

Coloris	Ref.	CHF
● anthracite	1002000	149.00



 LED E27 | 8W | 240°
 3000SK | 880lm | CEE=E
 8kWh / 1000h
 

Ref. : 1005289 | 12.90 CHF

Article	Ref.	CHF
Piquet		
● gris	231234	64.00
Boîte de connexion IP68, 3 pôles		
● noir	228730	21.30

GLOO PURE 70

Borne, E27

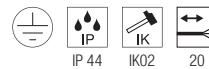
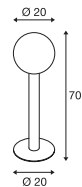

220-240V ~50/60Hz
Matière : aluminium / verre

- Câble nu



Douille : 1xE27 Ø max. : 4,8 cm L : 18 cm

Coloris	Ref.	CHF
● anthracite	1002001	160.00



 | 13,5W | 240°
 3000SK | 1520lm | CEE=E
 14kWh / 1000h
 

Ref. : 1005307 | 13.80 CHF

Article	Ref.	CHF
Piquet		
● gris	231234	64.00
Boîte de connexion IP68, 3 pôles		
● noir	228730	21.30



227221 657

227219 657



ROTOBALL 25
FL, E27

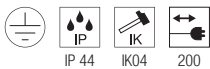
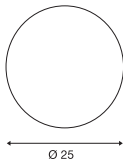

220-240V ~50/60Hz
Matière : acier / polyéthylène (PE)

- Fiche IP 44



Douille : 1xE27

Coloris	Ref.	CHF
○ blanc	227219	202.00



A60 | 7,5W | 320°
2700SK | 800lm | CEE=F
8kWh / 1000h



Ref. : 1005303 | 12.90 CHF

ROTOBALL 40
FL, E27

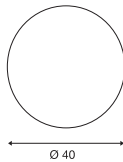

220-240V ~50/60Hz
Matière : acier / polyéthylène (PE)

- Fiche IP44



Douille : 1xE27

Ø max. : 9,5 cm

Coloris	Ref.	CHF
○ blanc	227220	229.00



LED E27 | 8W | 240°
3000SK | 880lm | CEE=E
8kWh / 1000h



Ref. : 1005289 | 12.90 CHF

ROTOBALL 50
FL, E27

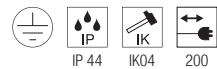
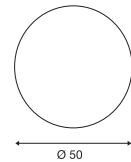

220-240V ~50/60Hz
Matière : acier / polyéthylène (PE)

- Fiche IP44



Douille : 1xE27

Ø max. : 9,5 cm

Coloris	Ref.	CHF
○ blanc	227221	279.00



A60 | 7,5W | 320°
2700SK | 800lm | CEE=F
8kWh / 1000h



Ref. : 1005303 | 12.90 CHF

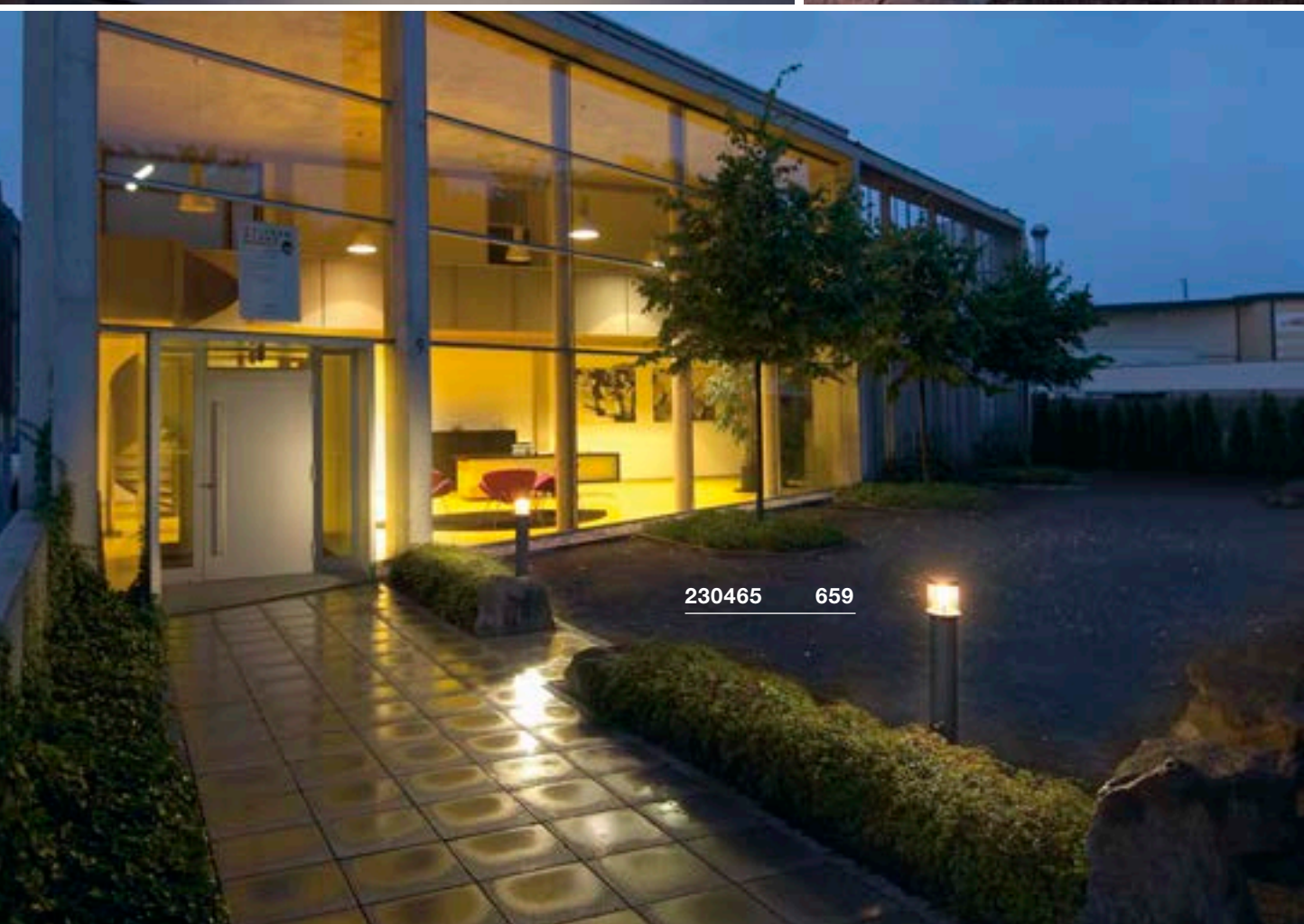
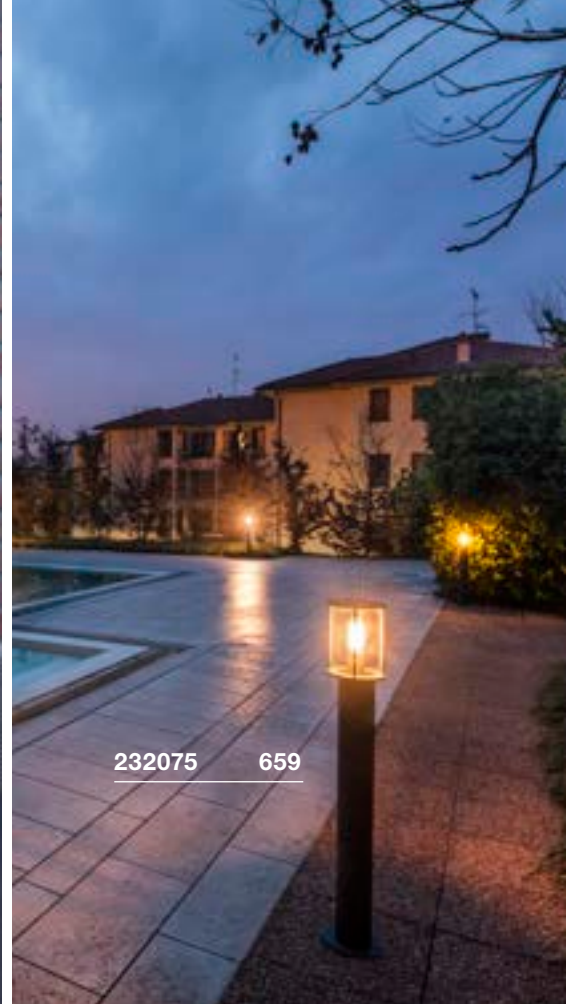



PHOTONIA PD, E27

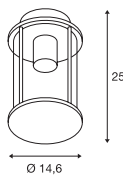

220-240V ~50/60Hz
Matière : aluminium / verre

- Chaîne de suspension incluse, patère en option
- Fiche IP44

SOCKET INSIDE <60 W

Douille : 1xE27 Ø max. : 9 cm L : 15 cm

Coloris	Ref.	CHF
● anthracite	232065	289.00



LED E27 | 7,5W | 320°
2700SK | 800lm | CEE=F
8kWh / 1000h



Ref. : 1005268 | 13.80 CHF



Article	Ref.	CHF
Patère		
● anthracite	1000398	88.00

PHOTONIA Borne, E27



220-240V ~50/60Hz
Matière : aluminium / verre

- Câble nu

SOCKET INSIDE <60 W

Douille : 1xE27 Ø max. : 9 cm L : 15 cm

Coloris	Ref.	CHF
● anthracite	232075	359.00



LED E27 | 7,5W | 320°
2500SK | 700lm | CEE=F
8kWh / 1000h



Ref. : 1005265 | 33.00 CHF



Article	Ref.	CHF
Accessoires de fixation pour béton		
● inox	232085	64.00
Boîte de connexion IP68, 3 pôles		
● noir	228730	21.30

OTOS GLAS Borne, E27

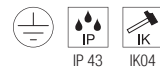
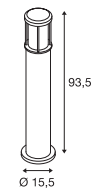

220-240V ~50/60Hz
Matière : aluminium / verre

- Accessoires de fixation pour béton inclus

SOCKET INSIDE <15 W

Douille : 1xE27 Ø max. : 6,5 cm L : 14,5 cm

Coloris	Ref.	CHF
● anthracite	230465	169.00



A60 | 7,5W | 320°
2700SK | 800lm | CEE=F
8kWh / 1000h



Ref. : 1005303 | 12.90 CHF



Article	Ref.	CHF
Kit de fixation		
● inox	228753	12.75
Boîte de connexion IP68, 3 pôles		
● noir	228730	21.30

CUBIX
FL, QPAR51

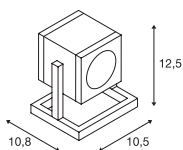

220-240V ~50/60Hz
Matière : aluminium / verre

• Fiche IP44



Douille : 1xGU10

Coloris	Ref.	CHF
● anthracite	132835	138.00

LED GU10 51mm | 6W | 38°
2700SK | 450lm | CEE=F
6kWh / 1000h

Ref. : 1005077 | 10.60 CHF

CONE
FL, E27

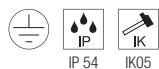
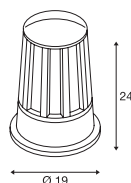

220-240V ~50/60Hz
Matière : aluminium / verre



Douille : 1xE27 L max. : 15 cm

Coloris	Ref.	CHF
● anthracite	230435	125.00

LED E27 | 7,5W | 320°
2500SK | 700lm | CEE=F
8kWh / 1000h

Ref. : 1005265 | 33.00 CHF





1000821 661



1000822 661

MOLAT
PD, E27

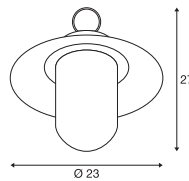

220-240V ~50/60Hz
Matière : aluminium / verre

- Chaîne de suspension incluse, patère en option
- Fiche IP44



Douille : 1xE27 Ø max. : 6,5 cm L : 14,5 cm

Coloris	Ref.	CHF
● anthracite	1000821	185.00



LED E27 | 7,5W | 320°
2700SK | 800lm | CEE=F
8kWh / 1000h



Ref. : 1005268 | 13.80 CHF



Article	Ref.	CHF
Patère		
● anthracite	1000398	88.00

MOLAT
Borne, E27

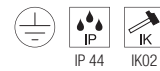
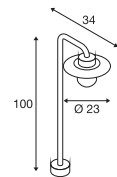

220-240V ~50/60Hz
Matière : aluminium / verre



Douille : 1xE27 Ø max. : 6,5 cm L : 14,5 cm

Coloris	Ref.	CHF
● anthracite	1000822	239.00



LED E27 | 7,5W | 320°
2500SK | 700lm | CEE=F
8kWh / 1000h



Ref. : 1005265 | 33.00 CHF



Article	Ref.	CHF
Piquet		
● gris	230060	64.00

LISENNE 40
Borne, E27

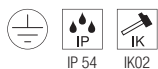
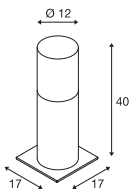

220-240V ~50/60Hz
Matière : basalte / verre



Douille : 1xE27 Ø max. : 5,9 cm L : 15 cm

Coloris	Ref.	CHF
● gris	1000665	475.00



LED E27 | 7,5W | 320°
2700SK | 800lm | CEE=F
8kWh / 1000h



Ref. : 1005268 | 13.80 CHF



Article	Ref.	CHF
Piquet		
● gris	229422	55.00

LISENNE 70
Borne, E27

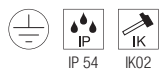
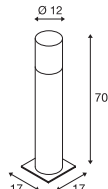

220-240V ~50/60Hz
Matière : basalte / verre



Douille : 1xE27 Ø max. : 5,9 cm L : 15 cm

Coloris	Ref.	CHF
● gris	1000666	539.00



LED E27 | 7,5W | 320°
2700SK | 800lm | CEE=F
8kWh / 1000h



Ref. : 1005268 | 13.80 CHF



Article	Ref.	CHF
Piquet		
● gris	229422	55.00

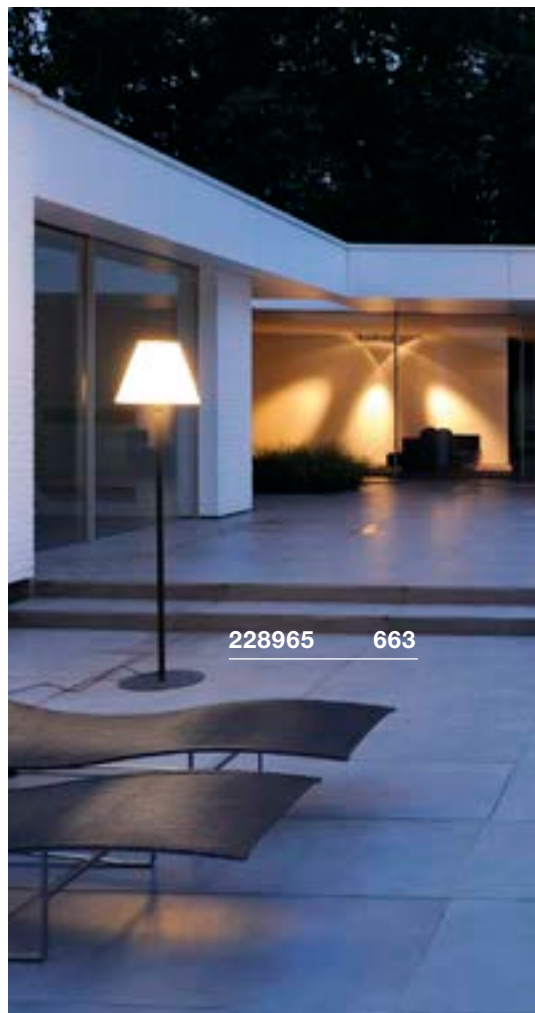

228965 663



ADEGAN MANILA
FL, E27

ADEGAN
FL, E27

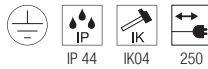
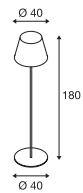
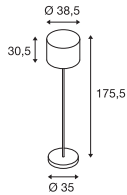

220-240V ~50/60Hz
Matière : granite / acier inoxydable

- Fiche IP44



Douille : 1xE27 Ø max. : 4,8 cm L : 18 cm

Coloris	Ref.	CHF
● inox / anthracite	1002494	499.00



LED E27 | 8W | 240°
3000SK | 880lm | CEE=E
8kWh / 1000h



Ref. : 1005289 | 12.90 CHF

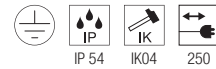

220-240V ~50/60Hz
Matière : aluminium / polycarbonate (PC)

- Fiche IP44



Douille : 1xE27 Ø max. : 5,2 cm

Coloris	Ref.	CHF
● anthracite	228965	399.00



LED E27 | 8W | 240°
3000SK | 880lm | CEE=E
8kWh / 1000h



Ref. : 1005289 | 12.90 CHF



Article	Ref.	CHF
Piquet		
● anthracite	228960	48.00



228935 665



228925 665



ALPA MUSHROOM 45
Borne, E27

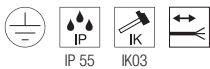
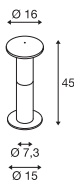

220-240V ~50/60Hz
Matière : aluminium / polycarbonate (PC)

- Câble nu



Douille : 1xE27 Ø max. : 5,2 cm L : 16 cm

Coloris	Ref.	CHF
● anthracite	228935	149.00



LED E27 | 8W | 240°
3000SK | 880lm | CEE=E
8kWh / 1000h



Ref. : 1005289 | 12.90 CHF



Article	Ref.	CHF
Accessoires de fixation pour béton		
○ argent	228712	79.00
Piquet		
● gris	228722	74.00
Boîte de connexion IP68, 3 pôles		
● noir	228730	21.30

ALPA MUSHROOM 75
Borne, E27

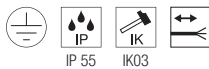
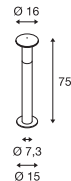

220-240V ~50/60Hz
Matière : aluminium / polycarbonate (PC)

- Câble nu



Douille : 1xE27 Ø max. : 5,2 cm L : 16 cm

Coloris	Ref.	CHF
● anthracite	228945	209.00



LED E27 | 8W | 240°
3000SK | 880lm | CEE=E
8kWh / 1000h



Ref. : 1005289 | 12.90 CHF



Article	Ref.	CHF
Accessoires de fixation pour béton		
○ argent	228712	79.00
Piquet		
● gris	228722	74.00
Boîte de connexion IP68, 3 pôles		
● noir	228730	21.30

ALPA CONE 100
Borne, E27

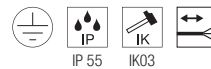
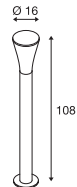

220-240V ~50/60Hz
Matière : aluminium / polycarbonate (PC)

- Câble nu



Douille : 1xE27 Ø max. : 5,2 cm L : 17,5 cm

Coloris	Ref.	CHF
● anthracite	228925	229.00



| 13,5W | 240°
3000SK | 1520lm | CEE=E
14kWh / 1000h



Ref. : 1005307 | 13.80 CHF



Article	Ref.	CHF
Accessoires de fixation pour béton		
○ argent	228712	79.00
Piquet		
● gris	228722	74.00
Boîte de connexion IP68, 3 pôles		
● noir	228730	21.30

APONI 90
Borne, PHASE

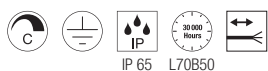
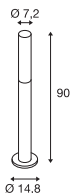

220-240V ~50/60Hz | 500mA
Puissance totale : 6,3W
Matière : aluminium

- Câble nu



Down 520lm | 3000K

Coloris	Ref.	CHF
● anthracite	1000682	289.00



Article	Ref.	CHF
Boîte de connexion IP68, 3 pôles		
● noir	228730	21.30

APONI 120
Borne, PHASE

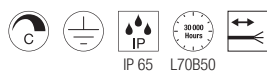
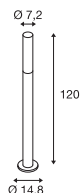

220-240V ~50/60Hz | 500mA
Puissance totale : 6,3W
Matière : aluminium

- Câble nu



Down 520lm | 3000K

Coloris	Ref.	CHF
● anthracite	1000683	379.00



Article	Ref.	CHF
Boîte de connexion IP68, 3 pôles		
● noir	228730	21.30



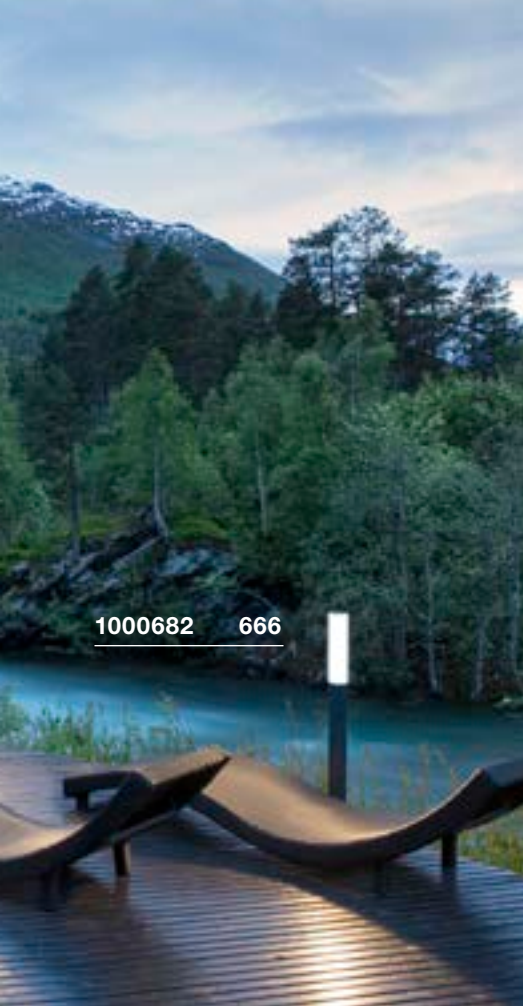

1000682 666

TRUST 30 Borne

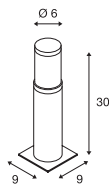

220-240V ~50/60Hz
Puissance totale : 9W
Matière : acier inoxydable 316



Down 400lm | 3000K

Coloris	Ref.	CHF
● noir	228100	279.00



Article	Ref.	CHF
Piquet		
● noir	227922	64.00
Grille en forme d'anneau		
● inox	228130	117.00
Boîte de connexion IP68, 3 pôles		
● noir	228730	21.30

228110 667



TRUST 60 Borne

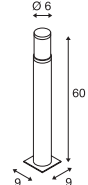

220-240V ~50/60Hz
Puissance totale : 9W
Matière : acier inoxydable 316



Down 400lm | 3000K

Coloris	Ref.	CHF
● noir	228110	359.00



Article	Ref.	CHF
Piquet		
● noir	227922	64.00
Grille en forme d'anneau		
● inox	228130	117.00
Boîte de connexion IP68, 3 pôles		
● noir	228730	21.30

BIG NAILS 50
Borne, E27

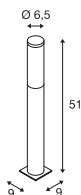

220-240V ~50/60Hz
Matière : acier inoxydable 304 / polycarbonate (PC)



Douille : 1xE27 Ø max. : 4,5 cm L : 17 cm

Coloris	Ref.	CHF
● inox	229162	192.00

LED E27 | 8W | 240°
3000SK | 880lm | CEE=E
8kWh / 1000h

Ref. : 1005289 | 12.90 CHF

Article	Ref.	CHF
Piquet		
● noir	227922	64.00

BIG NAILS 80
Borne, E27

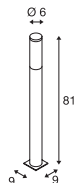

220-240V ~50/60Hz
Matière : acier inoxydable 304 / polycarbonate (PC)



Douille : 1xE27 Ø max. : 4,5 cm L : 17 cm

Coloris	Ref.	CHF
● inox	229172	209.00

| 13,5W | 240°
3000SK | 1520lm | CEE=E
14kWh / 1000h

Ref. : 1005307 | 13.80 CHF

Article	Ref.	CHF
Piquet		
● noir	227922	64.00

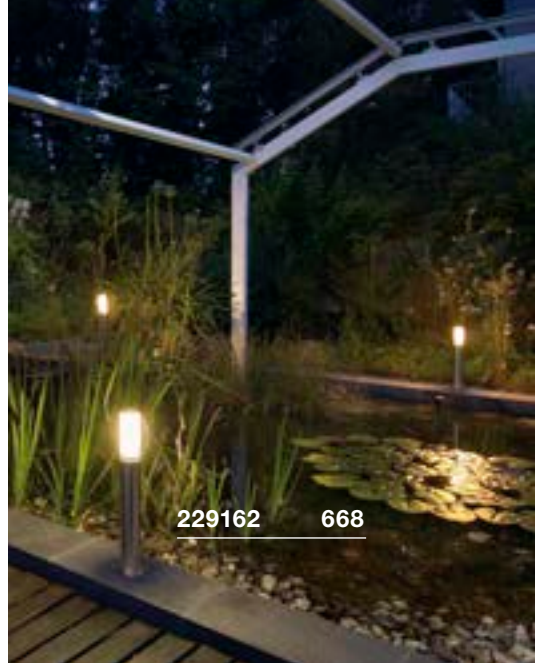

229162 668



229172 668



1001490 669



ROX ACRYL 30

Borne, E27

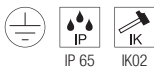
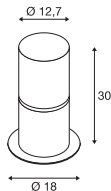

220-240V ~50/60Hz
Matière : acier inoxydable 304



Douille : 1xE27 Ø max. : 6 cm L : 15 cm

Coloris	Ref.	CHF
● inox	1001488	209.00



LED E27 | 8W | 240°
3000SK | 880lm | CEE=E
8kWh / 1000h



Ref. : 1005289 | 12.90 CHF



Article	Ref.	CHF
Accessoires de fixation pour béton		
● inox	1001494	33.00
Piquet		
● gris	231234	64.00
Boîtier de connexion en T		
● noir	228726	33.00

ROX ACRYL 60

Borne, E27

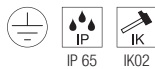
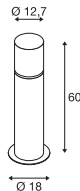

220-240V ~50/60Hz
Matière : acier inoxydable 304



Douille : 1xE27 Ø max. : 6 cm L : 15 cm

Coloris	Ref.	CHF
● inox	1001489	229.00



LED E27 | 8W | 240°
3000SK | 880lm | CEE=E
8kWh / 1000h



Ref. : 1005289 | 12.90 CHF



Article	Ref.	CHF
Accessoires de fixation pour béton		
● inox	1001494	33.00
Piquet		
● gris	231234	64.00
Boîtier de connexion en T		
● noir	228726	33.00

ROX ACRYL 90

Borne, E27

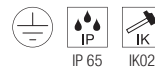
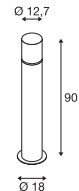

220-240V ~50/60Hz
Matière : acier inoxydable 304



Douille : 1xE27 Ø max. : 6 cm L : 15 cm

Coloris	Ref.	CHF
● inox	1001490	255.00



| 13,5W | 240°
3000SK | 1520lm | CEE=E
14kWh / 1000h



Ref. : 1005307 | 13.80 CHF



Article	Ref.	CHF
Accessoires de fixation pour béton		
● inox	1001494	33.00
Piquet		
● gris	231234	64.00
Boîtier de connexion en T		
● noir	228726	33.00



230066 671



23006 671



VAP SLIM 30
Borne, E27

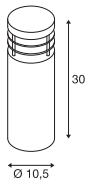

220-240V ~50/60Hz
Matière : acier inoxydable 304



Douille : 1xE27 Ø max. : 5,1 cm L : 12,6 cm

Coloris	Ref.	CHF
● inox	230063	209.00



LED E27 | 8W | 240°
3000SK | 880lm | CEE=E
8kWh / 1000h



Ref. : 1005289 | 12.90 CHF



Article	Ref.	CHF
Accessoires de fixation pour béton		
● inox	230061	29.90
Piquet		
● gris	230060	64.00

VAP SLIM 60
Borne, E27



220-240V ~50/60Hz
Matière : acier inoxydable 304



Douille : 1xE27 Ø max. : 5,1 cm L : 12,6 cm

Coloris	Ref.	CHF
● inox	230066	229.00



LED E27 | 8W | 240°
4000SK | 920lm | CEE=E
8kWh / 1000h



Ref. : 1005290 | 12.90 CHF



Article	Ref.	CHF
Accessoires de fixation pour béton		
● inox	230061	29.90
Piquet		
● gris	230060	64.00

VAP SLIM 90
Borne, E27



220-240V ~50/60Hz
Matière : acier inoxydable 304



Douille : 1xE27 Ø max. : 5,1 cm L : 12,6 cm

Coloris	Ref.	CHF
● inox	230069	279.00



LED E27 | 8W | 240°
3000SK | 880lm | CEE=E
8kWh / 1000h



Ref. : 1005289 | 12.90 CHF



Article	Ref.	CHF
Accessoires de fixation pour béton		
● inox	230061	29.90
Piquet		
● gris	230060	64.00

C-POL
Borne, E27

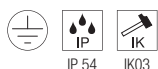
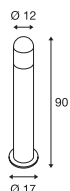

220-240V ~50/60Hz
Matière : aluminium / polycarbonate (PC)



Douille : 1xE27 Ø max. : 5,2 cm L : 17,3 cm

Coloris	Ref.	CHF
● anthracite	231475	239.00

| 13,5W | 240°
 3000SK | 1520lm | CEE=E

 14kWh / 1000h

Ref. : 1005307 | 13.80 CHF

Article	Ref.	CHF
Boîte de connexion IP68, 3 pôles		
● noir	228730	21.30

F-POL
Borne, E27

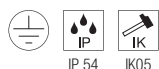
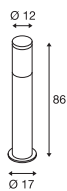

220-240V ~50/60Hz
Matière : aluminium / polycarbonate (PC)



Douille : 1xE27 Ø max. : 5,1 cm L : 14,8 cm

Coloris	Ref.	CHF
● anthracite	231595	239.00

LED E27 | 8W | 240°
 3000SK | 880lm | CEE=E

 8kWh / 1000h

Ref. : 1005289 | 12.90 CHF

Article	Ref.	CHF
Boîte de connexion IP68, 3 pôles		
● noir	228730	21.30

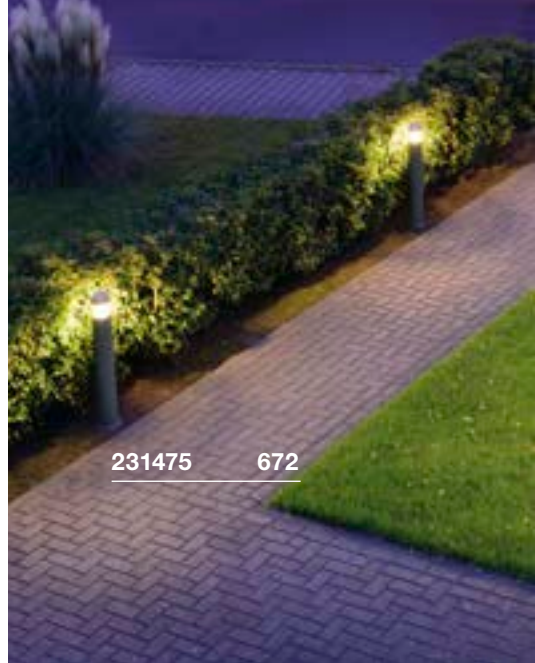

231475 672

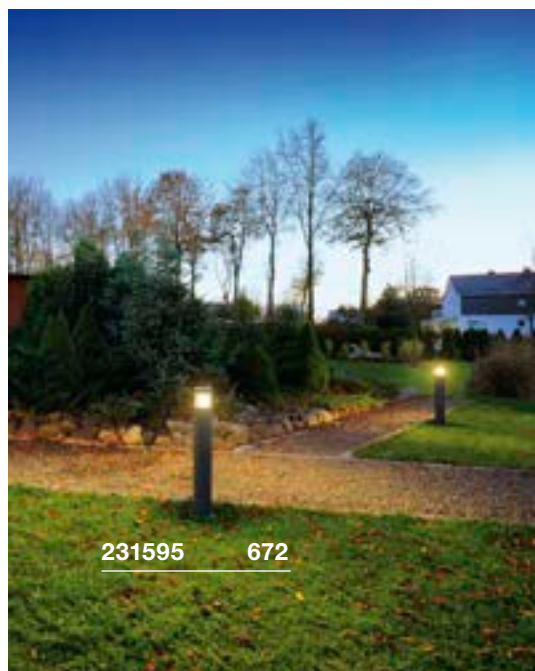

231595 672

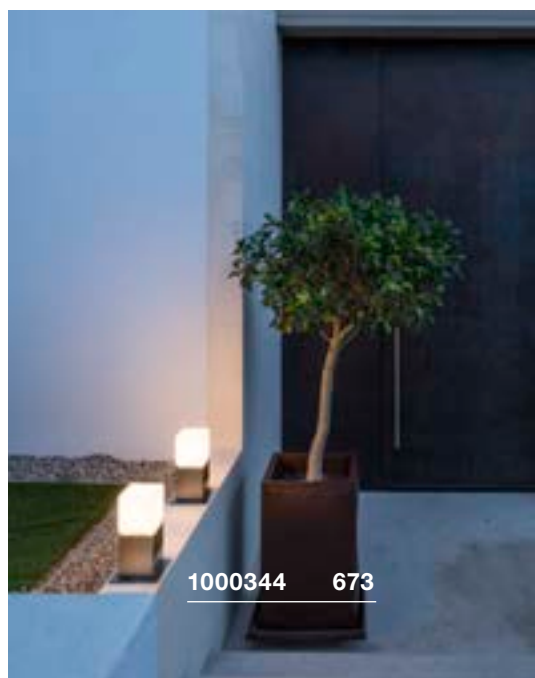

1000344 673



CARRÉ BORNE 30

Borne, E27

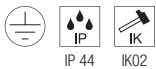
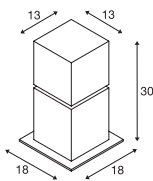

220-240V ~50/60Hz
Matière : acier inoxydable 304



Douille : 1xE27 Ø max. : 6 cm L : 15 cm

Coloris	Ref.	CHF
● inox	1000344	289.00



LED E27 | 8W | 240°
3000SK | 880lm | CEE=E
8kWh / 1000h



Ref. : 1005289 | 12.90 CHF



Article	Ref.	CHF
Accessoires de fixation pour béton		
● inox	1000343	64.00
Piquet		
● gris	231234	64.00
Boîte de connexion IP68, 3 pôles		
● noir	228730	21.30

CARRÉ BORNE 60

Borne, E27

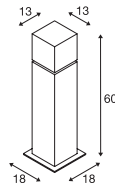

220-240V ~50/60Hz
Matière : acier inoxydable 304



Douille : 1xE27 Ø max. : 6 cm L : 15 cm

Coloris	Ref.	CHF
● inox	1000345	359.00



| 13,5W | 240°
3000SK | 1520lm | CEE=E
14kWh / 1000h



Ref. : 1005307 | 13.80 CHF



Article	Ref.	CHF
Accessoires de fixation pour béton		
● inox	1000343	64.00
Piquet		
● gris	231234	64.00
Boîte de connexion IP68, 3 pôles		
● noir	228730	21.30

CARRÉ BORNE 90

Borne, E27

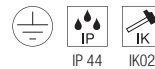
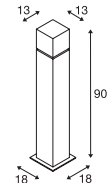

220-240V ~50/60Hz
Matière : acier inoxydable 304



Douille : 1xE27 Ø max. : 6 cm L : 15 cm

Coloris	Ref.	CHF
● inox	1000346	399.00



| 13,5W | 240°
3000SK | 1520lm | CEE=E
14kWh / 1000h



Ref. : 1005307 | 13.80 CHF



Article	Ref.	CHF
Accessoires de fixation pour béton		
● inox	1000343	64.00
Piquet		
● gris	231234	64.00
Boîte de connexion IP68, 3 pôles		
● noir	228730	21.30



231455 675



SLOTS 45 Borne

SLOTS 65 Borne

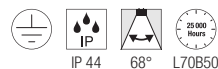
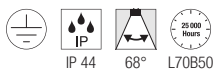
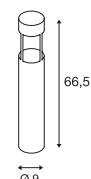
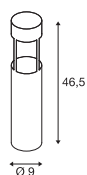

220-240V ~50/60Hz
Puissance totale : 4,5W
Matière : aluminium

220-240V ~50/60Hz
Puissance totale : 4,5W
Matière : aluminium

• Accessoires de fixation pour béton inclus

• Accessoires de fixation pour béton inclus



Down 200lm | 3000K



Down 200lm | 3000K

Coloris	Ref.	CHF
● anthracite	231815	209.00
● rouille	231817	209.00

Coloris	Ref.	CHF
● anthracite	231455	229.00
● rouille	231457	229.00

H-POL 30 Borne

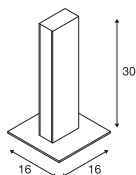

100-277V ~50/60Hz | 480mA
Puissance totale : 9,7W
Matière : aluminium / plastique

- Ce produit est conçu pour un encastrement dans le sol
- Un pot d'encastrement est disponible pour un éventuel montage en pleine terre.
Dimensions d'encastrement :
L : 14 cm, l : 14 cm, P : 16 cm



Down 350lm | 3000K

Coloris	Ref.	CHF
● anthracite	232155	309.00



Article	Ref.	CHF
Pot d'encastrement, 14x14 cm		
● noir	232195	64.00

H-POL 60 Borne

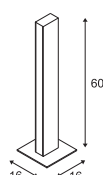

100-277V ~50/60Hz | 500mA
Puissance totale : 18W
Matière : aluminium / plastique

- Ce produit est conçu pour un encastrement dans le sol.
- Un pot d'encastrement est disponible pour un éventuel montage en pleine terre.
Dimensions d'encastrement :
L : 14 cm, l : 14 cm, P : 16 cm



Down 700lm | 3000K

Coloris	Ref.	CHF
● anthracite	232165	459.00



Article	Ref.	CHF
Pot d'encastrement, 14x14 cm		
● noir	232195	64.00

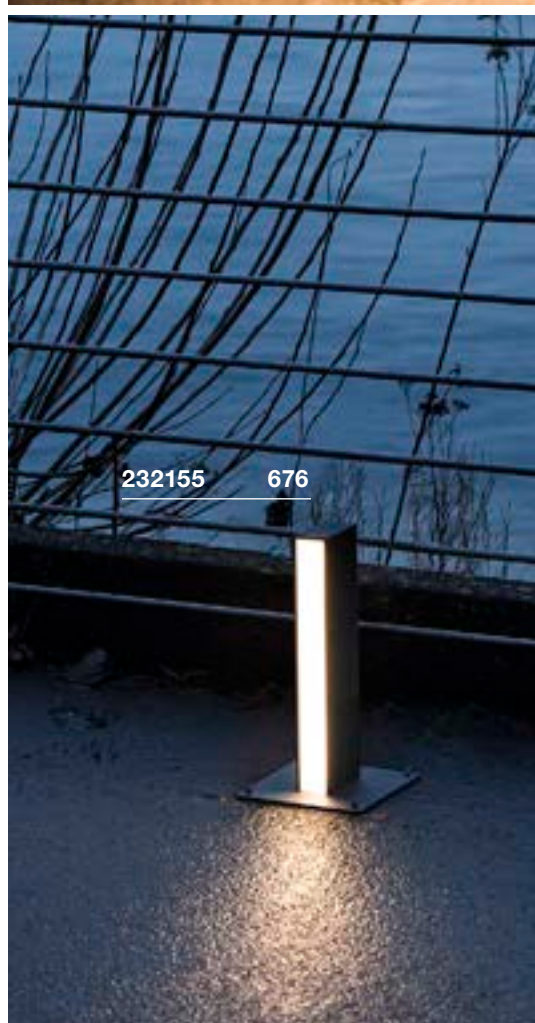

232155

676

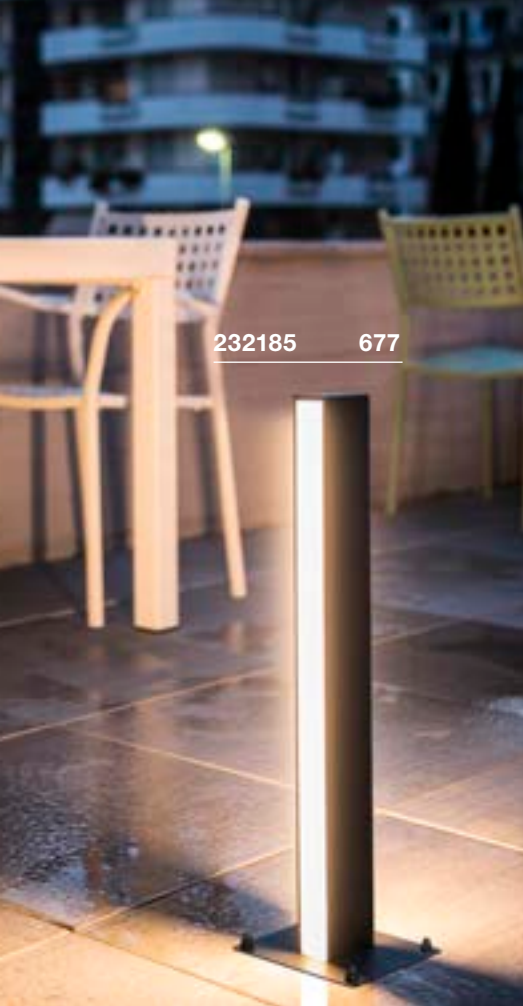

232185 677

H-POL TWIN 30 Borne

H-POL TWIN 60 Borne

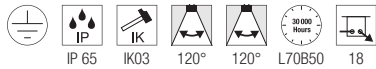
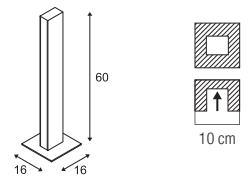
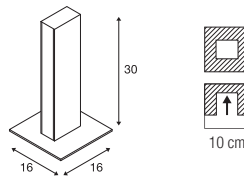

100-277V ~50/60Hz | 500mA
Puissance totale : 18W
Matière : aluminium / plastique

220-240V ~50/60Hz | 1000mA
Puissance totale : 35W
Matière : aluminium / plastique

- Ce produit est conçu pour un encastrement dans le sol.
- Un pot d'encastrement est disponible pour un éventuel montage en pleine terre.
Dimensions d'encastrement :
L : 14 cm, l : 14 cm, P : 16 cm

- Ce produit est conçu pour un encastrement dans le sol.
- Un pot d'encastrement est disponible pour un éventuel montage en pleine terre.
Dimensions d'encastrement :
L : 14 cm, l : 14 cm, P : 16 cm



Down 350lm | 3000K



Down 700lm | 3000K

Coloris	Ref.	CHF
● anthracite	232175	399.00

Coloris	Ref.	CHF
● anthracite	232185	579.00



Article	Ref.	CHF
Pot d'encastrement, 14x14 cm		
● noir	232195	64.00



Article	Ref.	CHF
Pot d'encastrement, 14x14 cm		
● noir	232195	64.00



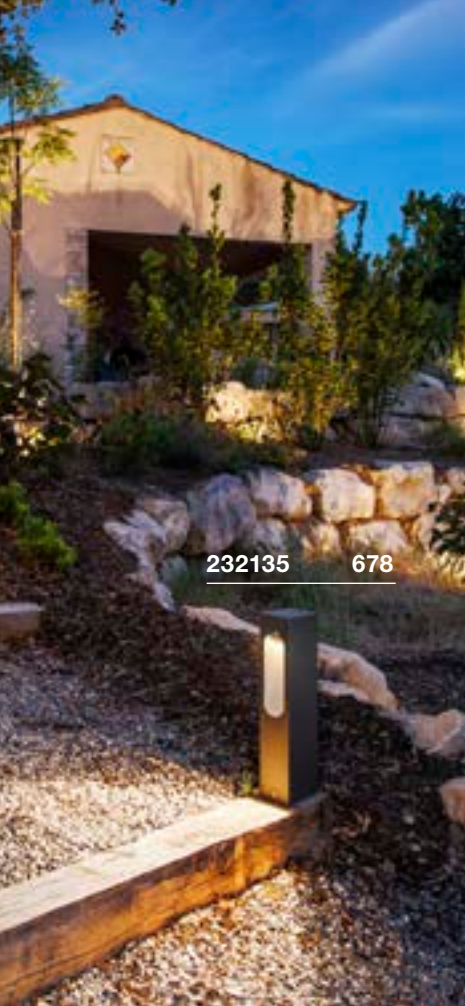

232135 678



232145 678

SLOTBOX 40

Borne

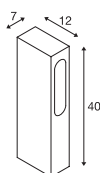

100-277V ~50/60Hz | 700mA
Puissance totale : 8W
Matière : aluminium

- Câble nu



Down 160lm | 3000K

Coloris	Ref.	CHF
● anthracite	232135	249.00



Article	Ref.	CHF
Boîte de connexion IP68, 3 pôles		
● noir	228730	21.30

SLOTBOX 70

Borne

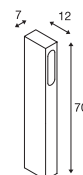

100-277V ~50/60Hz | 700mA
Puissance totale : 8,7W
Matière : aluminium

- Câble nu



Down 160lm | 3000K

Coloris	Ref.	CHF
● anthracite	232145	259.00



Article	Ref.	CHF
Boîte de connexion IP68, 3 pôles		
● noir	228730	21.30

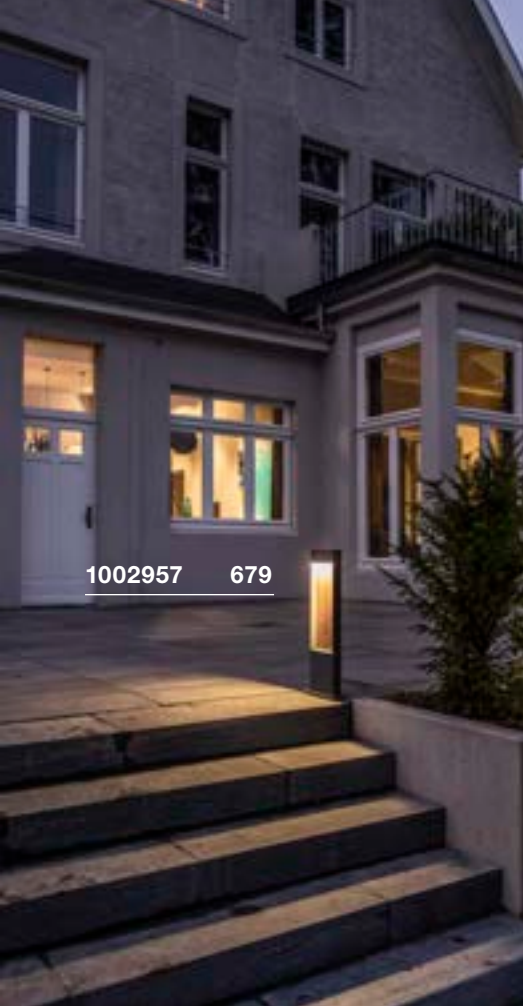

1002957 679



1002958 679

FLATT 65 Borne

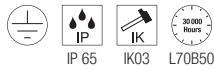
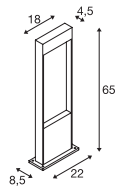
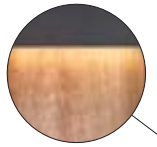

100-240V ~50/60Hz | 350mA
Puissance totale : 10W
Matière : aluminium / aluminium

- Température de couleur réglable avec interrupteur CCT switch



Down 400lm | 3000K | 400lm | 4000K

Coloris	Ref.	CHF
● anthracite	1002956	279.00
●● im. bois / anthracite	1002957	279.00



Article	Ref.	CHF
Boîte de connexion IP68, 3 pôles		
● noir	228730	21.30

FLATT 100 Borne

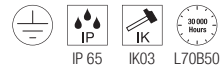
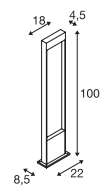

100-240V ~50/60Hz | 350mA
Puissance totale : 10W
Matière : aluminium / aluminium

- Température de couleur réglable avec interrupteur CCT switch



Down 400lm | 3000K | 400lm | 4000K

Coloris	Ref.	CHF
● anthracite	1002958	359.00
●● im. bois / anthracite	1002959	359.00



Article	Ref.	CHF
Boîte de connexion IP68, 3 pôles		
● noir	228730	21.30

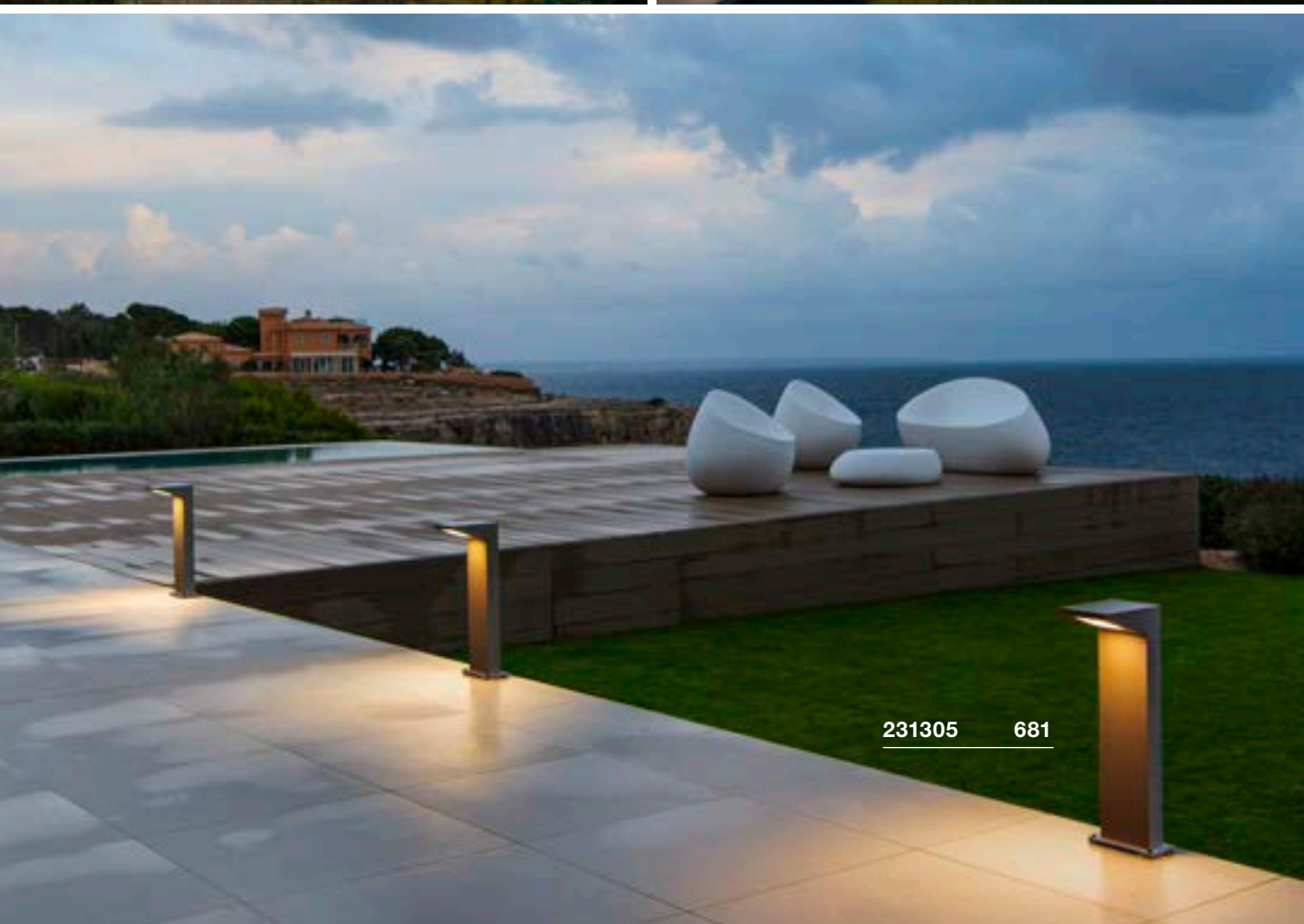



ABRIDOR 60 Borne

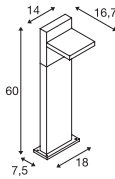

100-240V ~50/60Hz | 300mA
Puissance totale : 12W
Matière : aluminium



Down 950lm | 3000K | 980lm | 4000K

Coloris	Ref.	CHF
● anthracite	1002991	279.00

ABRIDOR 100 Borne

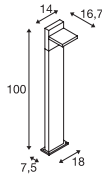

100-240V ~50/60Hz | 300mA
Puissance totale : 12W
Matière : aluminium



Down 950lm | 3000K | 980lm | 4000K

Coloris	Ref.	CHF
● anthracite	1002992	329.00

IPERI 50 Borne

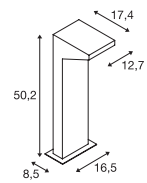

220-240V ~50/60Hz
Puissance totale : 4,5W
Matière : aluminium / plastique



Down 400lm | 4000K

Coloris	Ref.	CHF
● anthracite	231305	179.00



Article	Ref.	CHF
Piquet		
● gris	231231	64.00

QUADRASYL 75

Borne, TCR-TSE

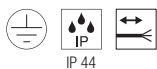
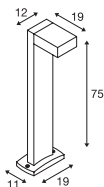

220-240V ~50/60Hz
Matière : aluminium

- Accessoires de fixation pour béton inclus
- Câble nu



Douille : 1xGX53 Ø max. : 7,5 cm L : 2,7 cm

Coloris	Ref.	CHF
● anthracite	232295	209.00
● gris	232294	209.00



LED GX53 | 6,1W | 120°
3000SK | 490lm | CEE=G
6kWh / 1000h



Ref. : 1005271 | 13.50 CHF



Article	Ref.	CHF
Boîtier de connexion en T		
● noir	228726	33.00



232295 682



1003001 683

QUAD BORNE

Borne

BOOKAT

Borne

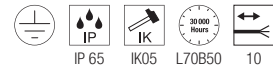
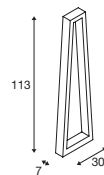
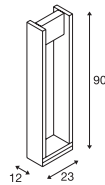

100-277V ~50/60Hz | 500mA
 Puissance totale : 18W
 Matière : aluminium / verre

100-277V ~50/60Hz | 700mA
 Puissance totale : 15W
 Matière : aluminium / polycarbonate (PC)

- Câble nu

- Boîte de connexion IP incluse
- Boîtier de raccordement IP



Down 1550lm | 3000K

Down 1240lm | 3000K | 1300lm | 4000K

Coloris	Ref.	CHF
● anthracite	1003001	509.00

Coloris	Ref.	CHF
● anthracite	1005441	469.00



Article	Ref.	CHF
Boîte de connexion IP68, 3 pôles		
● noir	228730	21.30

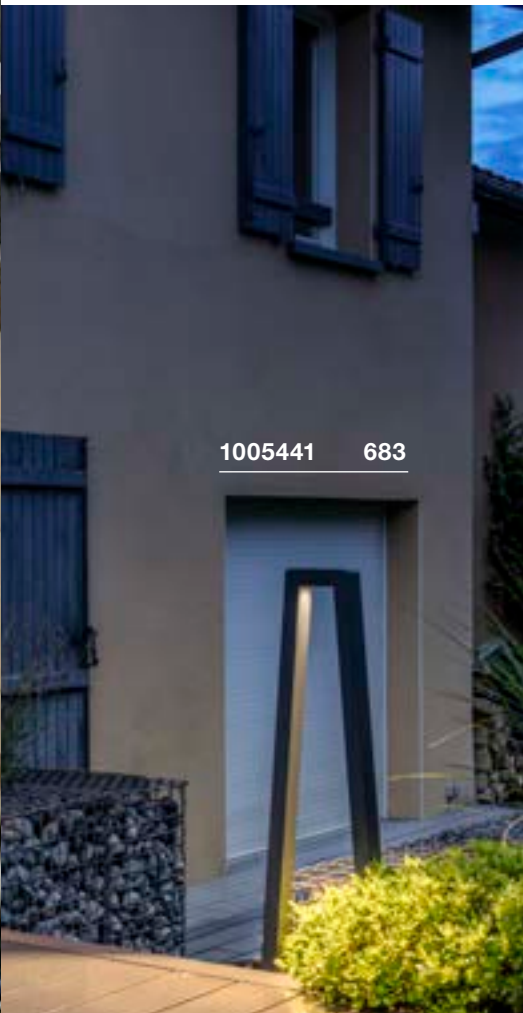

1005441 683

RASCALI 45
Borne

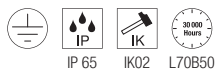
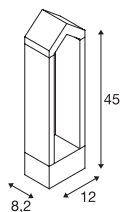

220-240V ~50/60Hz
Puissance totale : 8W
Matière : aluminium



Down 360lm | 3000K

Coloris	Ref.	CHF
● anthracite	1000799	209.00

RASCALI 65
Borne

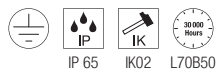
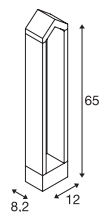

220-240V ~50/60Hz
Puissance totale : 8W
Matière : aluminium



Down 360lm | 3000K

Coloris	Ref.	CHF
● anthracite	1000801	239.00

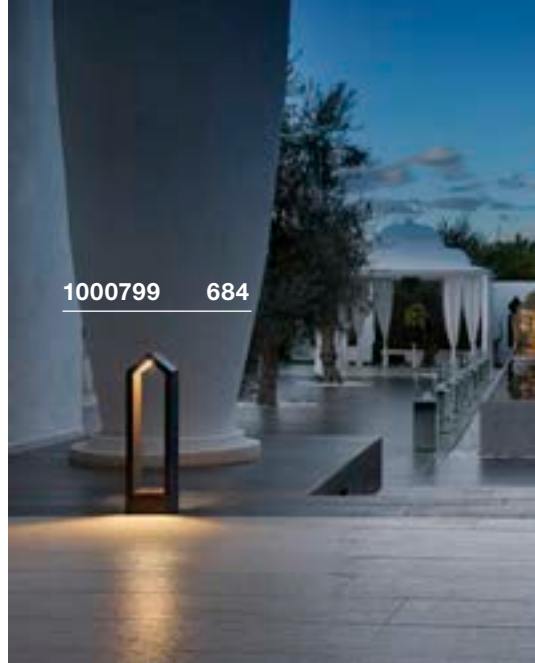

1000799 684



1000801 684

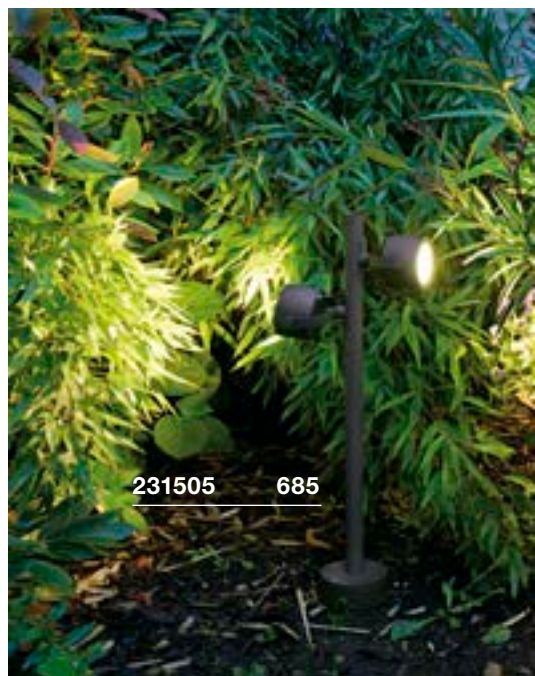

231505 685



MYRA SPOT
Double, GU10



SITRA 360
Borne, TCR-TSE

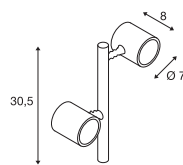

220-240V ~50/60Hz
Matière : aluminium

- La hauteur du luminaire peut être augmentée en ajoutant 2 tiges d'extension maximum.
- Câble nu

SOCKET INSIDE <4.5 W

Douilles : 2xGU10 Ø max. : 5,1 cm L : 5,7 cm

Coloris	Ref.	CHF
● anthracite	233185	229.00



LED GU10 51mm | 6W | 38°
2700SK | 450lm | CEE=F
6kWh / 1000h



Ref. : 1005075 | 10.60 CHF



Article	Ref.	CHF
Accessoires de fixation pour béton		
● argent	228712	79.00
Kit de fixation		
● inox	228752	9.50
Embase		
● anthracite	233145	33.00
Tige d'extension 30 cm		
● anthracite	233165	33.00

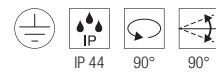
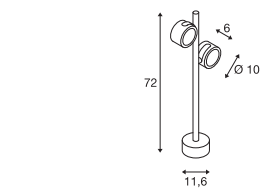

220-240V ~50/60Hz
Matière : aluminium / verre

SOCKET INSIDE <9 W

Douilles : 2xGX53 Ø max. : 7,5 cm L : 3,5 cm

Coloris	Ref.	CHF
● anthracite	231505	209.00



LED GX53 | 6,1W | 120°
3000SK | 490lm | CEE=G
6kWh / 1000h



Ref. : 1005271 | 13.50 CHF



Article	Ref.	CHF
Piquet		
● gris	230060	64.00





1001962 697



LED
SYNA PLANT | 689



LED
SYNA GARDEN | 689



LED
SYNA | 689



LED
FLOODI S | 691



LED
FLOODI M | 691



LED
FLOODI L | 691



LED
GALEN 60 | 692



LED
GALEN 120 | 692



LED
FLAC BEAM® | 693



S-CCKET
SAMRINA | 693



S-CCKET
NAUTILUS 10 | 694



S-CCKET
BIG NAUTILUS | 694



S-CCKET
NAUTILUS 10 | 695



LED
NAUTILUS 10 | 696



S-CCKET
NAUTILUS | 697



S-CCKET
NAUTILUS 10
SPOT | 697



LED
NAUTILUS 10
SPOT LED | 697



LED
DASAR®
PROJECTOR | 698



LED
DASAR® 920 | 698



LED
HELIA SPOT S | 699



LED
HELIA SPOT L | 699



S-CCKET
THEO BRACKET | 701



LED
LED SPIKE | 701



S-CCKET
SITRA 360 SPIKE | 703



S-CCKET
SITRA 360 SPIKE | 703



227505 689

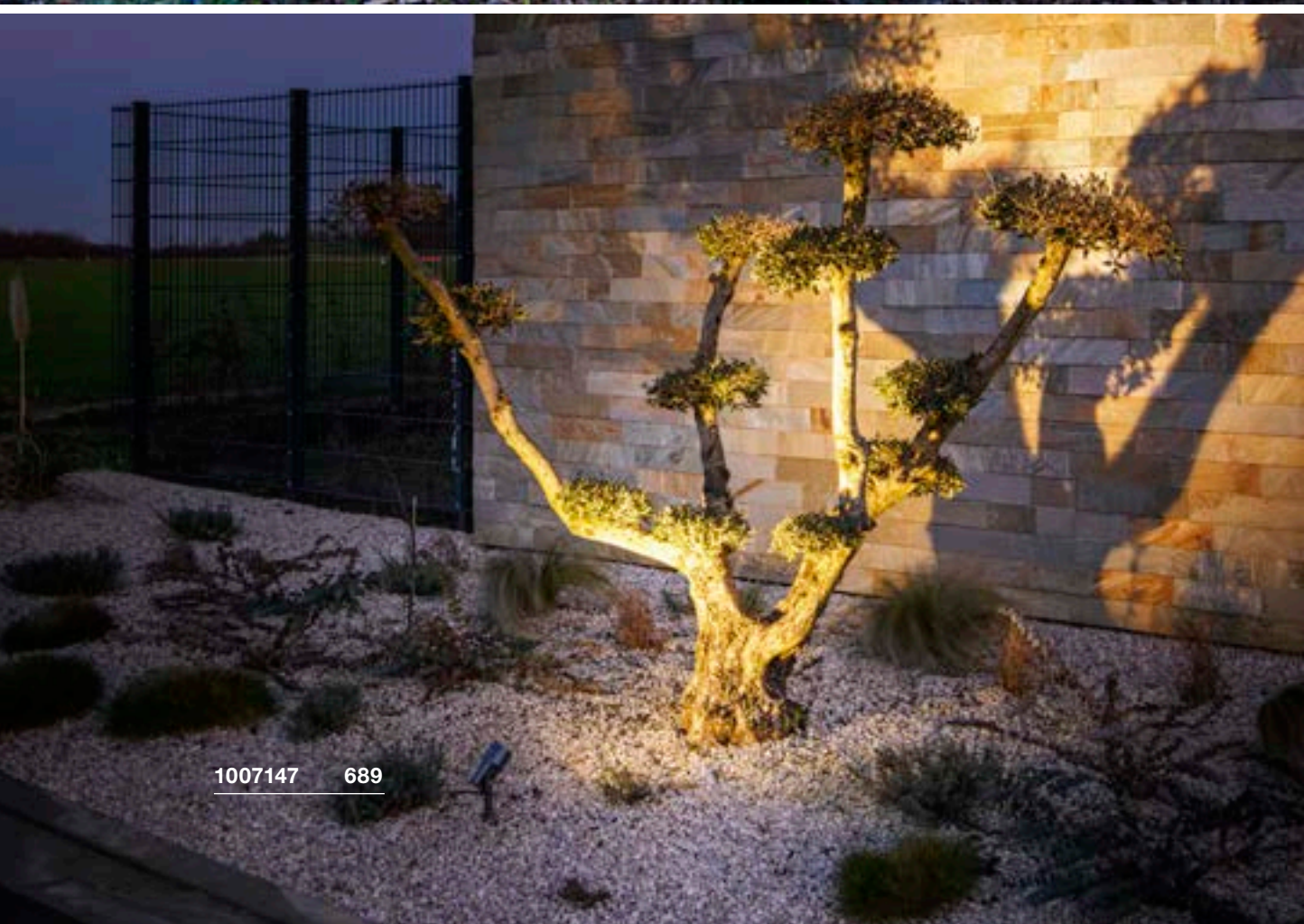

1007147 689



SYNA PLANT SP

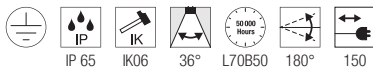
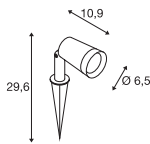

220-240V ~50/60Hz | 250mA
Puissance totale : 6W
Matière : aluminium

- Fiche IP44



Down 540lm | 3000K

Coloris	Ref.	CHF
● noir	1007146	80.90

SYNA GARDEN SP

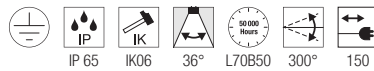
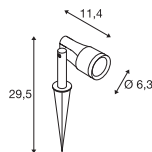

220-240V ~50/60Hz | 250mA
Puissance totale : 6W
Matière : aluminium

- Fiche IP44



Down 540lm | 3000K

Coloris	Ref.	CHF
● noir	1007147	86.90

SYNA SP

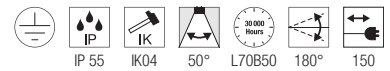
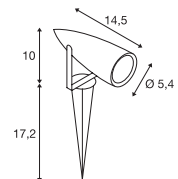

220-240V ~50/60Hz | 250mA
Puissance totale : 9W
Matière : aluminium / acrylique

- Fiche IP44



Down 470lm | 3000K

Coloris	Ref.	CHF
● anthracite	227505	106.00



1006193 691



FLOODI S
SP

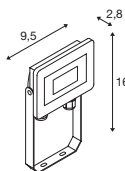

220-240V ~50/60Hz
Puissance totale : 9,3W
Matière : aluminium



Down 1040lm | 3000K

Coloris	Ref.	CHF
● anthracite	1006191	35.00



Article	Ref.	CHF
Capteur ● noir	1006326	34.90

FLOODI M
SP

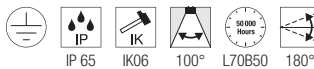
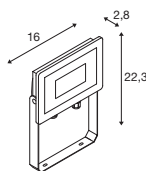

220-240V ~50/60Hz
Puissance totale : 30W
Matière : aluminium



Down 2980lm | 3000K

Coloris	Ref.	CHF
● anthracite	1006192	55.00



Article	Ref.	CHF
Capteur ● noir	1006326	34.90

FLOODI L
SP

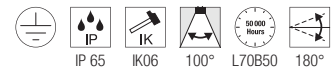
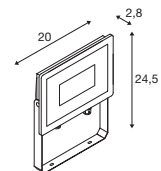

220-240V ~50/60Hz
Puissance totale : 48W
Matière : aluminium



Down 5150lm | 3000K

Coloris	Ref.	CHF
● anthracite	1006193	69.00



Article	Ref.	CHF
Capteur ● noir	1006326	34.90

GALEN 60 SP

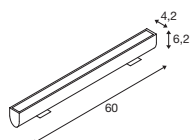

220-240V ~50/60Hz | 450mA
Puissance totale : 18W
Matière : aluminium / verre



Down 1570lm | 3000K | 1570lm | 4000K

Coloris	Ref.	CHF
● anthracite	1003447	269.00



Article	Ref.	CHF
Câble de raccordement 5 m, nu		
● noir	231960	33.95
Câble de connexion 1,0 m		
● noir	231961	22.90

GALEN 120 SP

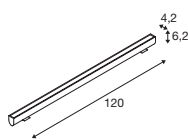

220-240V ~50/60Hz | 900mA
Puissance totale : 34W
Matière : aluminium / verre



Down 3000lm | 3000K | 3100lm | 4000K

Coloris	Ref.	CHF
● anthracite	1003448	379.00



Article	Ref.	CHF
Câble de raccordement 5 m, nu		
● noir	231960	33.95
Câble de connexion 1,0 m		
● noir	231961	22.90





FLAC BEAM® SP

SAMRINA SP, simple, GU10

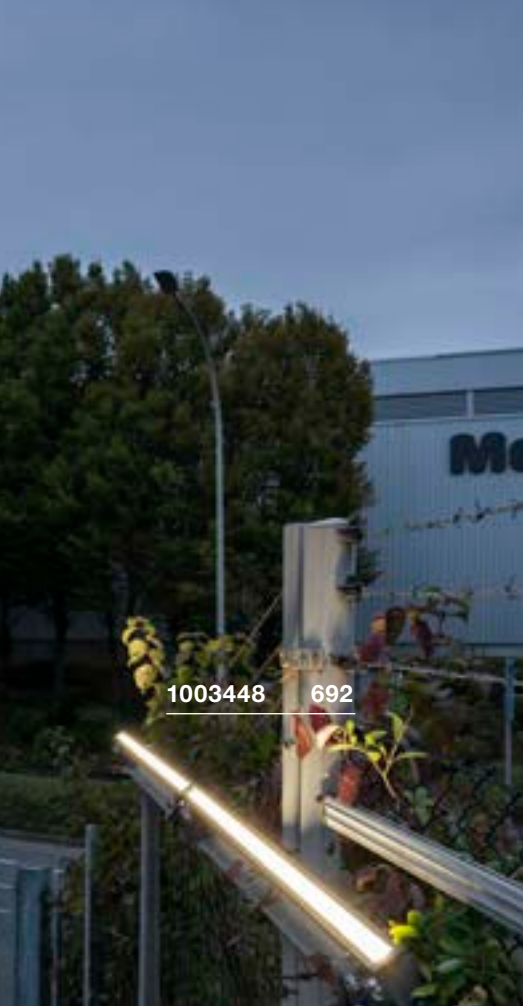

1003448 692

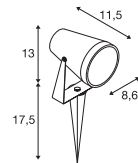
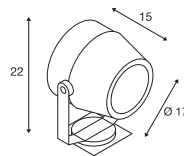

220-240V ~50/60Hz
Puissance totale : 27W
Matière : aluminium / verre

220-240V ~50/60Hz
Matière : plastique / verre

- Fiche IP44

- Contient des matériaux recyclés
- Fiche IP44



Down 1600lm | 3000K

Douille : GU10 Ø max. : 6 cm | L : 6 cm

Coloris	Ref.	CHF
● gris	231072	539.00

Coloris	Ref.	CHF
● noir	1004757	49.10



LED GU10 51mm | 6W | 38°
2700K | 450lm | CEE=F
6kWh / 1000h



Ref. : 1005077 | 10.60 CHF



NAUTILUS 10
SP, rond, QPAR51

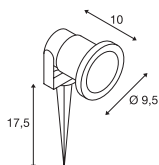

220-240V ~50/60Hz
Matière : aluminium

- Fiche IP44



Douille : 1xGU10 L max. : 5,7 cm

Coloris	Ref.	CHF
● gris	227418	45.90



LED GU10 51mm | 6W | 38°
2700K | 450lm | CEE=F
6kWh / 1000h



Ref. : 1005077 | 10.60 CHF

BIG NAUTILUS
SP, rond, QPAR51

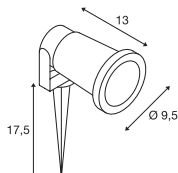

220-240V ~50/60Hz
Matière : aluminium

- Fiche IP44



Douille : GU10 Ø max. : 5,1 cm L : 8,3 cm

Coloris	Ref.	CHF
● noir	227410	49.10
● rouille	1001964	49.10
● vert	1001965	49.10



LED GU10 51mm | 6W | 38°
2700K | 450lm | CEE=F
6kWh / 1000h



Ref. : 1005077 | 10.60 CHF

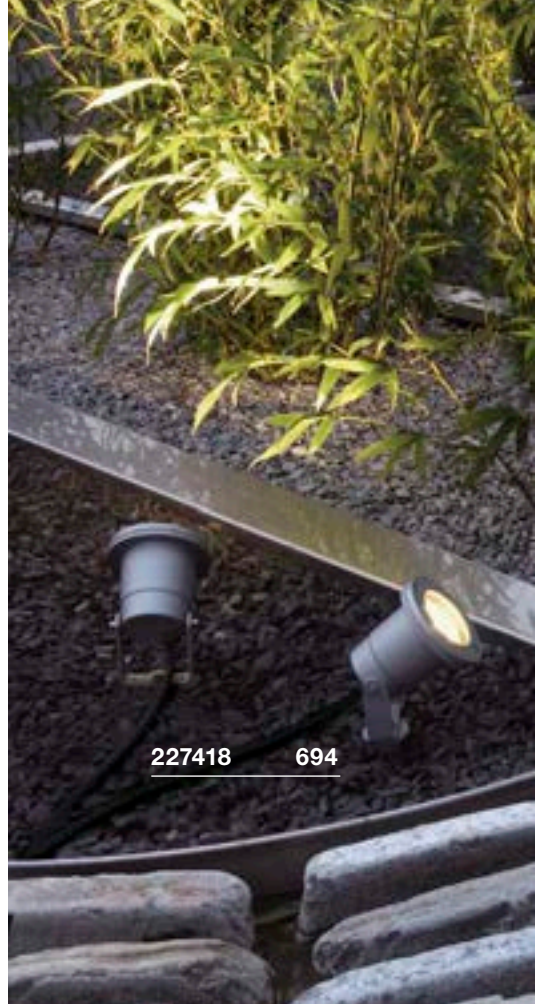

227418 694

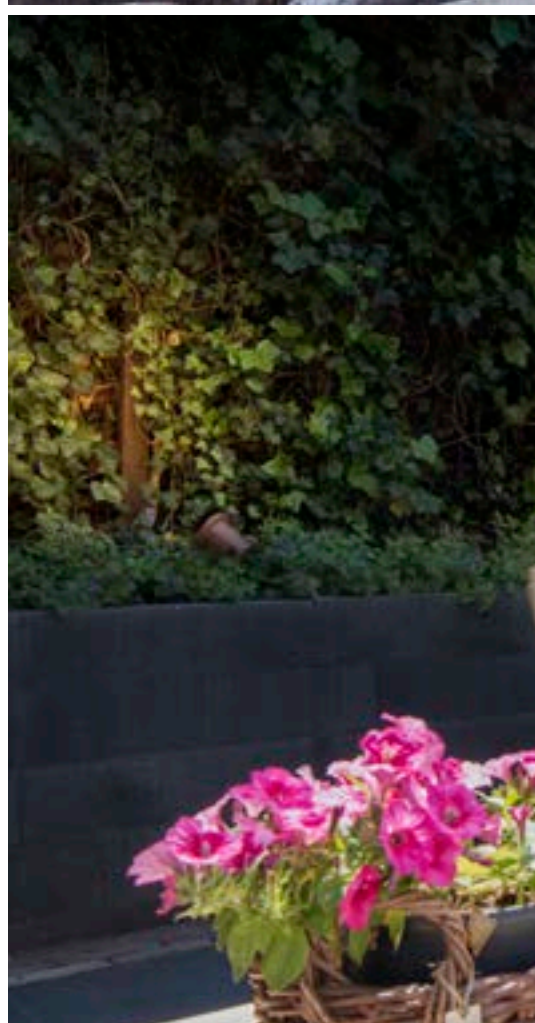



NAUTILUS 10 SP, rond, QPAR51

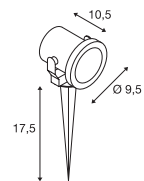

220-240V ~50/60Hz
Matière : acier inoxydable 316

- Fiche IP44

SOCKET
INSIDE  <25 W

Douille : 1xGU10 Ø max. : 5,1 cm L : 5,7 cm

Coloris	Ref.	CHF
● inox	229740	138.00



LED GU10 51mm | 6W | 38°
2700K | 450lm | CEE=F
6kWh / 1000h



Ref. : 1005077 | 10.60 CHF

1001964 694



231035 696

NAUTILUS 10 SP, carré

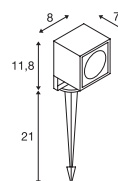

100-277V ~50/60Hz | 700mA
Puissance totale : 8,5W
Matière : aluminium / verre

- Fiche IP44



1001962 697



Down

660lm | 3000K

Coloris	Ref.	CHF
● anthracite	231035	209.00



NAUTILUS SP, QR-C51

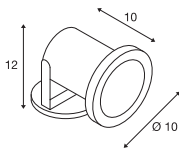

12V ~50Hz
Matière : acier inoxydable 304 / verre

- Câble nu



Douille : 1xGX5.3

Coloris	Ref.	CHF
● inox	229090	124.00



LED GU5.3 | 5,8W | 36°
2700K | 450lm | CEE=G
6kWh / 1000h

Ref. : 1001574 | 49.10 CHF



NAUTILUS 10 SPOT SP, QPAR51

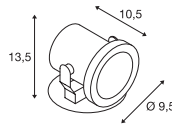

220-240V ~50/60Hz
Matière : acier inoxydable 316

- Câble nu



Douille : 1xGU10 Ø max. : 5,1 cm L : 6 cm

Coloris	Ref.	CHF
● inox	229741	138.00



LED GU10 51mm | 6W | 38°
2700K | 450lm | CEE=F
6kWh / 1000h

Ref. : 1005077 | 10.60 CHF



Article	Ref.	CHF
Boîte de connexion IP68, 3 pôles		
● noir	228730	21.30

NAUTILUS 10 SPOT LED SP

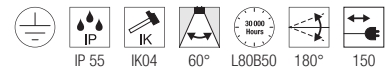
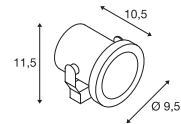

220-240V ~50/60Hz
Puissance totale : 9W
Matière : acier inoxydable 316

- Fiche IP44



Down 520lm | 3000K

Coloris	Ref.	CHF
● inox	1001962	160.00



Article	Ref.	CHF
Piquet plastique		
● noir	900011	5.25
Plaque de montage		
● inox	1001963	12.75

DASAR® PROJECTOR
SP, 12/24V

DASAR® 920
SP, 230V

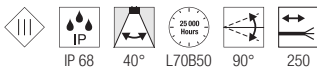
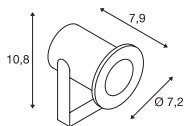
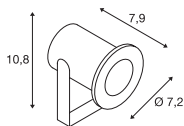

12-24V DC
Puissance totale : 6,5W
Matière : acier inoxydable 316 / verre

220-240V ~50/60Hz | 400mA
Puissance totale : 4,6W
Matière : acier inoxydable 316 / verre

• Câble nu

• Fiche IP44



Down 520lm | 3000K

Down 300lm | 3000K

Coloris	Ref.	CHF
● inox	233570	279.00

Coloris	Ref.	CHF
● inox	233571	359.00



Article	Ref.	CHF
Piquet acier inoxydable 316		
● inox	233580	24.50
Piquet plastique		
● noir	900011	5.25
Alimentation LED 15W 12 V		
○ blanc	1005444	35.00
Alimentation LED 15W 24 V		
○ blanc	1005445	35.00
Plaque de montage acier inoxydable 316		
● inox	233582	29.90

Article	Ref.	CHF
Piquet acier inoxydable 316		
● inox	233580	24.50
Piquet plastique		
● noir	900011	5.25
Plaque de montage acier inoxydable 316		
● inox	233582	29.90

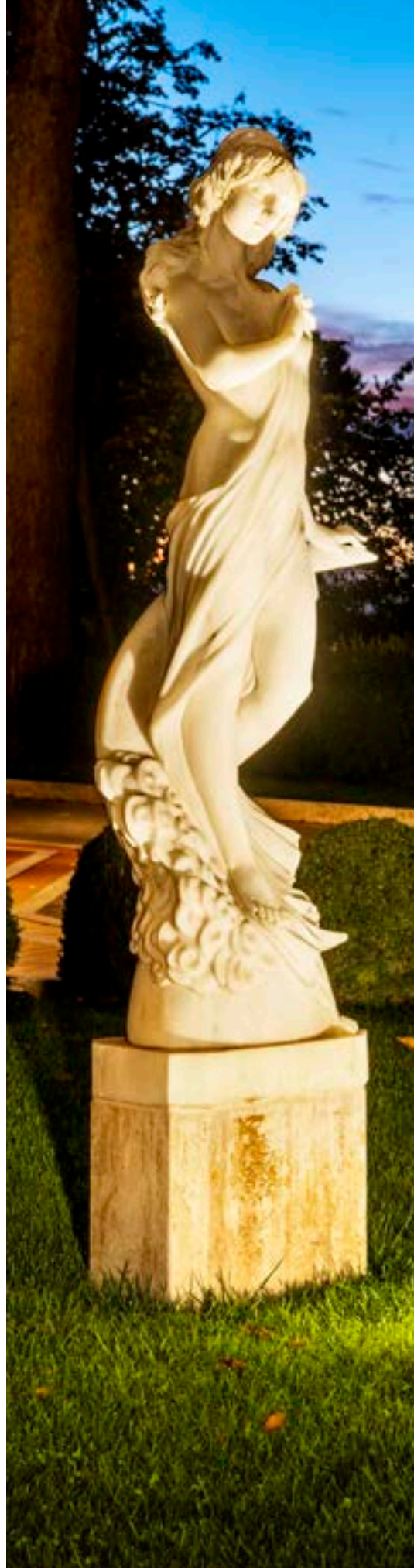



HELIA SPOT S

SP, simple

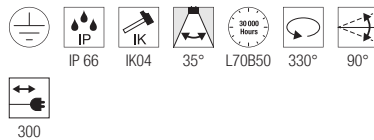
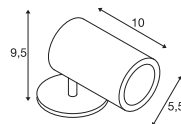

220-240V ~50/60Hz | 500mA
Puissance totale : 6,5W
Matière : aluminium

- Fiche IP44



Down 440lm | 3000K

Coloris	Ref.	CHF
● anthracite	1000735	219.00



Article	Ref.	CHF
Piquet		
● inox	1000736	27.70

HELIA SPOT L

SP, simple, PHASE

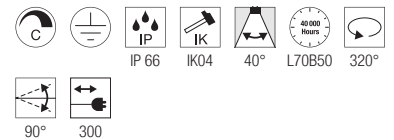
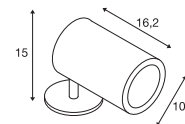

220-240V ~50/60Hz | 700mA
Puissance totale : 15W
Matière : aluminium / verre

- Fiche IP44



Down 1340lm | 3000K

Coloris	Ref.	CHF
● anthracite	228555	299.00



Article	Ref.	CHF
Piquet		
● inox	228560	34.90

233570 698



1004652 701

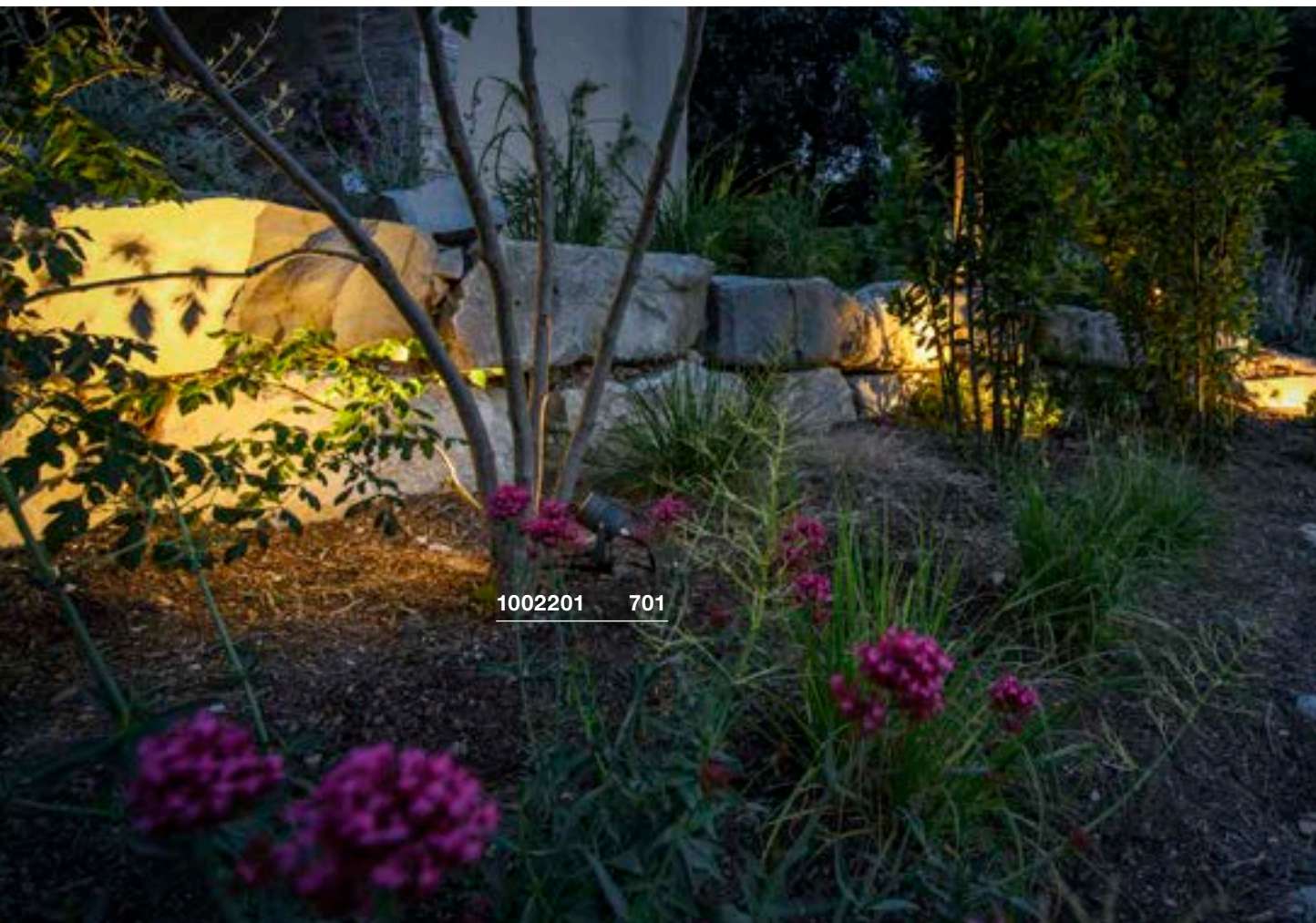

1002201 701



THEO BRACKET SP

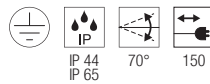
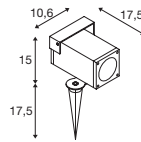

220-240V ~50/60Hz
Matière : aluminium / verre

- Fiche IP44



Douille : 1xGU10 Ø max. : 5,1 cm L : 5,7 cm

Coloris	Ref.	CHF
● anthracite	1004652	85.00



LED GU10 51mm | 6W | 38°
2700K | 450lm | CEE=F
6kWh / 1000h



Ref. : 1005077 | 10.60 CHF

LED SPIKE SP

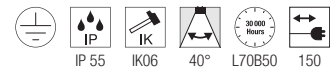
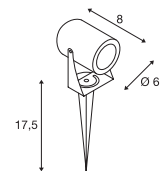

100-240V ~50/60Hz | 240mA
Puissance totale : 6W
Matière : aluminium / verre

- Fiche IP44



Down 400lm | 3000K

Coloris	Ref.	CHF
● anthracite	1002201	79.00
● rouille	1002203	79.00



231535 703



SITRA 360 SPIKE
SP, simple, TCR-TSE

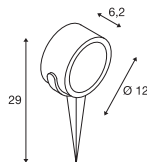

220-240V ~50/60Hz
Matière : aluminium / verre

- Fiche IP44

SOCKET INSIDE <9
W

Douille : 1xGX53 Ø max. : 7,5 cm L : 3,5 cm

Coloris	Ref.	CHF
● anthracite	231525	85.00



LED GX53 | 6,1W | 120°
3000K | 490lm | CEE=G
6kWh / 1000h



Ref. : 1005271 | 13.50 CHF

SITRA 360 SPIKE
SP, double, TCR-TSE

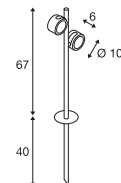

220-240V ~50/60Hz
Matière : aluminium / verre

- Fiche IP44

SOCKET INSIDE <9
W

Douilles : 2xGX53 Ø max. : 7,5 cm L : 3,5 cm

Coloris	Ref.	CHF
● anthracite	231535	219.00



LED GX53 | 6,1W | 120°
3000K | 490lm | CEE=G
6kWh / 1000h



Ref. : 1005271 | 13.50 CHF



234515

735



NEW

SCKET
PHOTONI | 709



NEW

LED
LID II | 711



NEW

LED
LID II | 711



NEW

LED
LID I | 713



NEW

LED
LID I | 713



NEW

LED
I-RING | 714



NEW

LED
OVAL 14 | 715



NEW

LED
OVAL 18 | 715



NEW

LED
CONCRETO M | 717



NEW

LED
CONCRETO L | 717



LED
VANO WING | 719



LED
VANO WING | 719



LED
MANA BASE | 720



NEW

LED
RUSTY® MANA | 720



NEW

LED
RUSTY® MANA | 720



LED
MANA OUT | 721



NEW

LED
MANA OUT | 721



NEW

LED
ENOLA OCULUS | 723



NEW

LED
ENOLA
OCULUS | 723



LED
ENOLA
OCULUS S | 725



LED
ENOLA
OCULUS M | 725



LED
ENOLA
ROUND L | 725



LED
ENOLA ROUND S
UP/DOWN | 727



LED
ENOLA ROUND M
UP/DOWN | 727



LED
ENOLA ROUND L
UP/DOWN | 727



LED
ENOLA
SQUARE S | 729



LED
ENOLA
SQUARE M | 729



LED
ENOLA
SQUARE L | 729



LED
ENOLA SQUARE S
UP/DOWN | 730



LED
ENOLA SQUARE M
UP/DOWN | 730



LED
ENOLA SQUARE L
UP/DOWN | 730



SCKET
THEO UP/DOWN | 735



LED
BIG THEO BEAM UP/
FLOOD DOWN | 735



SCKET
BIG THEO
UP/DOWN | 735



LED
BIG THEO FLOOD
UP/DOWN | 736



SCKET
THEO | 736



SCKET
BIG THEO | 737



LED
BIG THEO | 737



LED
SITRA S | 739



LED
SITRA S | 739



LED
SITRA M | 741



LED
SITRA L | 741

NEW



SCKET
SITRA CUBE | 741



SCKET
GRAFIT | 742



SCKET
GRAFIT | 742



SCKET
GRAFIT | 743



SCKET
GRAFIT | 743



LED
QUADRULO | 744



SCKET
QUADRULO
SENSOR | 745



SCKET
QUADRULO | 745



SCKET
MERIDIAN | 746



SCKET
MERIDIAN BOX | 746



SCKET
MERIDIAN BOX
SENSOR | 747



SCKET
MERIDIAN BOX | 747



LED
ESKINA FRAME | 749



LED
ESKINA FRAME | 749



LED
ESKINA FRAME | 749



LED
BOOKAT | 751



LED
BIG QUAD | 752



LED
QUAD | 752



LED
QUAD
UP/DOWN 15 | 753



LED
BIG QUAD
UP/DOWN | 755



LED
BIG QUAD | 755



LED
RUSTY®
UP/DOWN | 756



LED
RUSTY®
UP/DOWN | 756



LED
OVALISK
SENSOR | 757



LED
OVALISK | 757



LED
PEMA® | 758



LED
PEMA® | 759



LED
PEMA® | 759



SCKET
PEMA® | 759



LED
FLATT SENSOR | 760



LED
FLATT | 760



SCKET
ASTINA | 761



SCKET
ASTINA STEEL | 761



LED
ANGOLUX
SENSOR | 762



LED
ANGOLUX | 762



LED
VILUA S | 763



LED
VILUA L | 763



LED
VILUA | 763



SCKET
MYRA
UP/DOWN | 764



LED
SITRA
UP/DOWN | 765



SCKET
SITRA
UP/DOWN | 765



SCKET
ROX | 767



SCKET
ROX UP/DOWN | 767



LED
DELWA | 767



LED
SLOTS | 768



SCKET
WALLYX | 768



LED
DOWNUNDER
OUT | 769



LED
DOWNUNDER
OUT | 769



LED
ABRIDOR
SENSOR | 770



LED
ABRIDOR | 770



LED
ORDI SENSOR | 771



LED
ORDI | 771



SCKET
BOX-L | 773



LED
BOX-L | 773



SCKET
BOX UP/DOWN | 773



LED
LOGS | 775



LED
OUT-BEAM UP /
FLOOD DOWN | 775



LED
L-LINE OUT | 775



SCKET
PHOTONIA | 777



SCKET
MOLAT | 777



SCKET
GLOO PURE | 777



SCKET
F-POL | 778



SCKET
SQUARE | 779



SCKET
KERAS ELT | 779



SCKET
SITRA | 779



LED
RASCALI | 780



LED
IPERI | 780



SCKET
QUADRASYL | 781



SCKET
SQUARE TURN | 781



LED
TODAY PRO | 783



LED
ESKINA D | 783



SCKET
MYRA DISPLAY | 783



LED
LED SPOT | 785



SCKET
NAUTILUS | 785



SCKET
MYRA | 785

1007585 709



PHOTONI
WL, E27

NEW

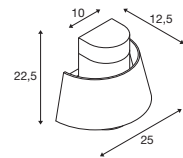

IP55

IK08

220-240V ~50/60Hz
Matière : aluminium

- Résiste à l'air marin

SOCKET
INSIDE

13
W

Douille : 1xE27

Ø max. : 6 cm

L : 11,6 cm

Coloris	Ref.	CHF
● noir	1007585	● 113.90
● rouille	1007581	● 113.90

LED E27 | 8W | 240°
3000K | 880lm | CEE=E
8kWh / 1000h

Ref. : 1005289 | 12.90 CHF



1007281 711



LID II
WL

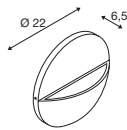

220-240V ~50/60Hz | 350mA
Puissance totale : 15W
Matière : aluminium



Down	800lm 2700K	800lm 3000K
------	---------------	---------------

Coloris	Ref.	CHF
● anthracite	1007282	● 125.40

LID II
WL, up/down

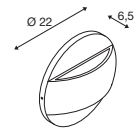

220-240V ~50/60Hz | 700mA
Puissance totale : 28W
Matière : aluminium



Up	750lm 2700K	750lm 3000K
Down	750lm 2700K	750lm 3000K

Coloris	Ref.	CHF
● anthracite	1007281	● 148.40

1007667 713





LID I
WL, simple

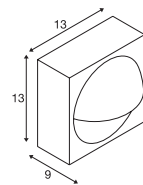

220-240V ~50/60Hz | 350mA
Puissance totale : 15W
Matière : aluminium



Down 900lm | 2700K | 1050lm | 3000K

Coloris	Ref.	CHF
● anthracite	1007667	● 165.60

LID I
WL, double

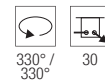
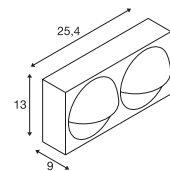

220-240V ~50/60Hz | 700mA
Puissance totale : 29W
Matière : aluminium



Spot 1 850lm | 2700K | 1000lm | 3000K
Spot 2 850lm | 2700K | 1000lm | 3000K

Coloris	Ref.	CHF
● anthracite	1007668	● 263.40



1007236 714

I-RING WL

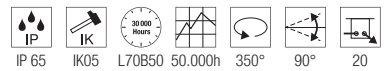
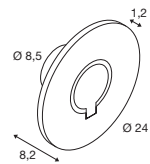

100-240V ~50/60Hz | 350mA
 Puissance totale : 9,2W
 Matière : aluminium



Down

670lm | 3000K

Coloris	Ref.	CHF
● anthracite	1007236	● 188.60



OVAL 14
WL, up/down

OVAL 18
WL, up/down

1007142 715

NEW



NEW

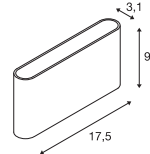
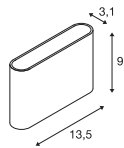

220-240V ~50/60Hz | 145mA
Puissance totale : 5,7W
Matière : aluminium / polycarbonate (PC)

220-240V ~50/60Hz | 275mA
Puissance totale : 9,3W
Matière : aluminium / polycarbonate (PC)



Up	280lm	2700K	280lm	3000K
Down	280lm	2700K	280lm	3000K

Up	430lm	2700K	430lm	3000K
Down	430lm	2700K	430lm	3000K

Coloris	Ref.	CHF
● noir	1007142	90.90
○ blanc	1007143	90.90

Coloris	Ref.	CHF
● noir	1007144	108.00
○ blanc	1007145	108.00

1006405 717





CONCRETO M WL

CONCRETO L WL

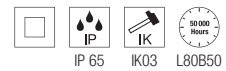
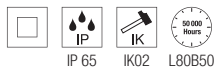
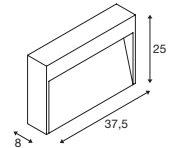
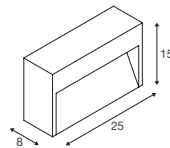

220-240V ~50/60Hz | 700mA
Puissance totale : 8,5W
Matière : béton / aluminium

220-240V ~50/60Hz | 700mA
Puissance totale : 12W
Matière : béton / aluminium



Down 270lm | 3000K

Down 470lm | 3000K

Coloris	Ref.	CHF
● gris	1006404	● 250.00

Coloris	Ref.	CHF
● gris	1006405	● 325.00

JAS DOMINICAS

ONASTERIO
A CATALINA DE SIENA



VANO WING SP, DALI

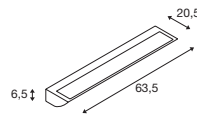

220-240V ~50/60Hz | 500mA
Puissance totale : 25W
Matière : aluminium / verre



Down 1400lm | 3000K

Coloris	Ref.	CHF
● gris	1006268	519.00

VANO WING SP, DALI

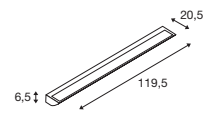

220-240V ~50/60Hz | 1050mA
Puissance totale : 49W
Matière : aluminium / verre



Down 3140lm | 3000K

Coloris	Ref.	CHF
● gris	1006270	645.00

MANA BASE
WL, rond, PHASE

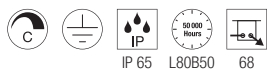
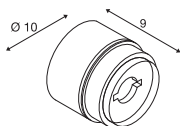

220-240V ~50/60Hz | 350mA
Puissance totale : 15W
Matière : aluminium / polycarbonate (PC)



Down 800lm | 2700K | 820lm | 3000K

Coloris	Ref.	CHF
● anthracite	1006319	229.00

RUSTY® MANA
Abat-jour, carré



NEW

L : 28 cm l : 28 cm H : 1,5 cm
Matière : acier FeCSI

Coloris	Ref.	CHF
● rouille	1006317	69.90

RUSTY® MANA
Abat-jour, rond



NEW

H : 1,5 cm Ø : 28 cm
Matière : acier FeCSI

Coloris	Ref.	CHF
● rouille	1006318	69.90

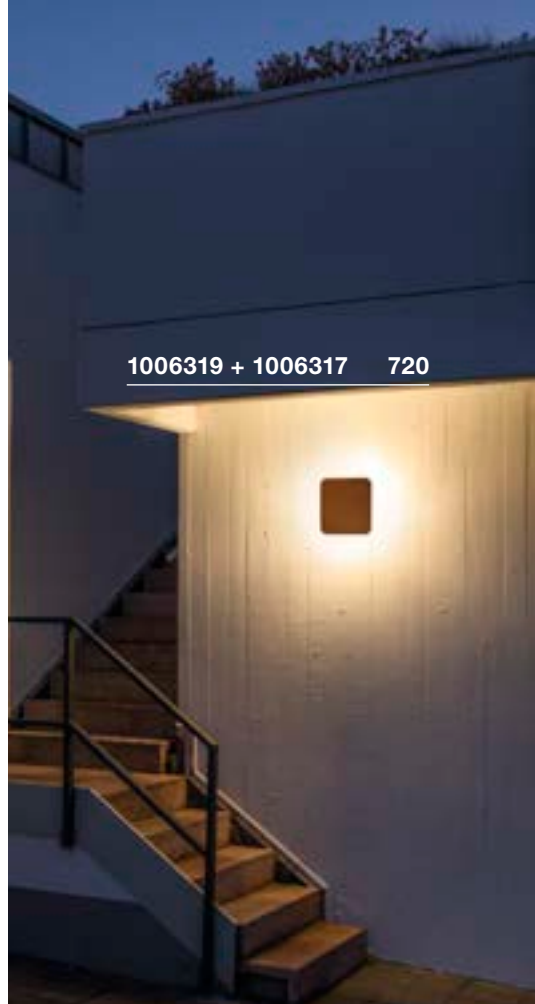



1002902 721



MANA OUT WL, PHASE

MANA OUT WL, Set

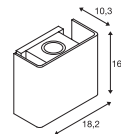
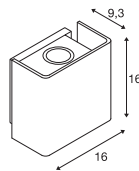

220-240V ~50/60Hz | 500mA
Puissance totale : 11W
Matière : aluminium / aluminium

220-240V ~50/60Hz | 500mA
Puissance totale : 11W
Matière : aluminium / béton



Up 325lm | 3000K
Down 325lm | 3000K

Up 325lm | 3000K
Down 325lm | 3000K

Coloris	Ref.	CHF
● anthracite	1002900	299.00
● rouille	1002902	329.00

Coloris	Ref.	CHF
● gris	1003470	325.00

1006328 723

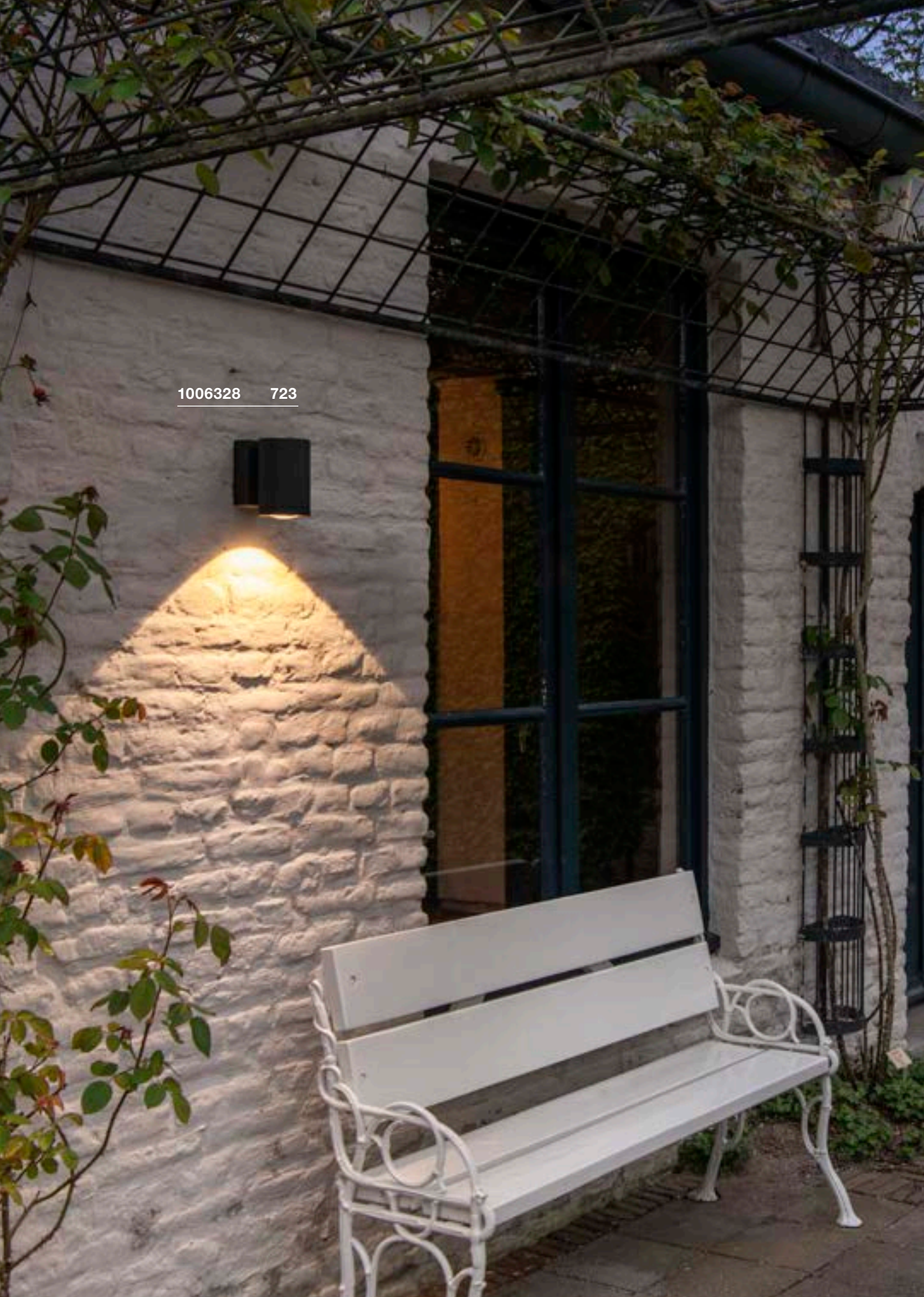



ENOLA OCULUS WL, simple



ENOLA OCULUS WL, up/down



1006329 723

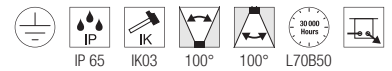
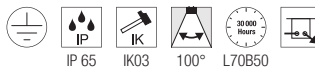
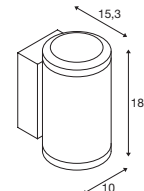
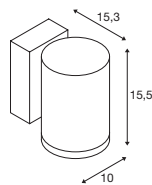

220-240V ~50/60Hz | 500mA
Puissance totale : 11W
Matière : aluminium / verre

220-240V ~50/60Hz | 500mA
Puissance totale : 20W
Matière : aluminium / verre



Down	1000lm 3000K	1100lm 4000K
------	----------------	----------------



Up	940lm 3000K	1060lm 4000K
Down	940lm 3000K	1060lm 4000K

Coloris	Ref.	CHF
● anthracite	1006328	● 349.00

Coloris	Ref.	CHF
● anthracite	1006329	● 459.00



Article	Ref.	CHF
Entretoises		
● anthracite	1002853	10.60



Article	Ref.	CHF
Entretoises		
● anthracite	1002853	10.60

1003440 725





ENOLA ROUND S WL, simple

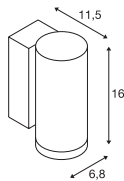

100-240V ~50/60Hz | 500mA
Puissance totale : 6W
Matière : aluminium / verre



Down 450lm | 3000K | 500lm | 4000K

Coloris	Ref.	CHF
● anthracite	1003422	259.00



Article	Ref.	CHF
Entretoises		
● anthracite	1002853	10.60
Réflecteur 60°		
● chrome	1005262	20.20

ENOLA ROUND M WL, simple

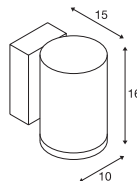

220-240V ~50/60Hz | 500mA
Puissance totale : 11W
Matière : aluminium / verre



Down 860lm | 3000K | 980lm | 4000K

Coloris	Ref.	CHF
● anthracite	1003423	319.00



Article	Ref.	CHF
Entretoises		
● anthracite	1002853	10.60
Lentille 19°		
● noir / chrome	1005205	52.00
Lentille asymétrique		
● noir / chrome	1005206	52.00
Réflecteur 60°		
● chrome	1005207	29.90

ENOLA ROUND L WL, simple

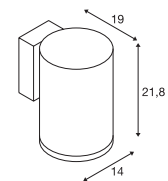

220-240V ~50/60Hz | 900mA
Puissance totale : 36W
Matière : aluminium / verre



Down 3300lm | 3000K | 3700lm | 4000K

Coloris	Ref.	CHF
● anthracite	1003440	379.00



Article	Ref.	CHF
Entretoises		
● anthracite	1002853	10.60
Réflecteur 60°		
● chrome	1005263	27.70



1003441 727



ENOLA ROUND S UP/DOWN WL

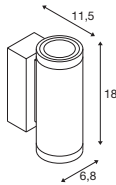

220-240V ~50/60Hz | 350mA
Puissance totale : 7,8W
Matière : aluminium / verre



Up	310lm	3000K	350lm	4000K
Down	310lm	3000K	350lm	4000K

Coloris	Ref.	CHF
● anthracite	1003424	319.00



Article	Ref.	CHF
Entretoises		
● anthracite	1002853	10.60
Réflecteur 60°		
● chrome	1005262	20.20

ENOLA ROUND M UP/DOWN WL

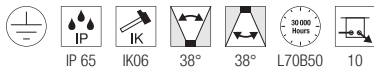
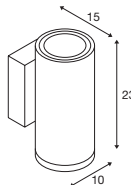

220-240V ~50/60Hz | 500mA
Puissance totale : 20W
Matière : aluminium / verre



Up	830lm	3000K	950lm	4000K
Down	830lm	3000K	950lm	4000K

Coloris	Ref.	CHF
● anthracite	1003425	379.00



Article	Ref.	CHF
Entretoises		
● anthracite	1002853	10.60
Lentille 19°		
● noir / chrome	1005205	52.00
Lentille asymétrique		
● noir / chrome	1005206	52.00
Réflecteur 60°		
● chrome	1005207	29.90

ENOLA ROUND L UP/DOWN WL

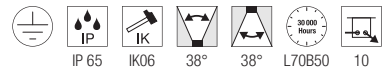
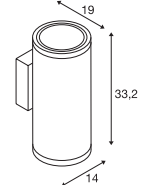

220-240V ~50/60Hz | 700mA
Puissance totale : 55W
Matière : aluminium / verre



Up	2700lm	3000K	3000lm	4000K
Down	2700lm	3000K	3000lm	4000K

Coloris	Ref.	CHF
● anthracite	1003441	520.00



Article	Ref.	CHF
Entretoises		
● anthracite	1002853	10.60
Réflecteur 60°		
● chrome	1005263	27.70



1003416 729

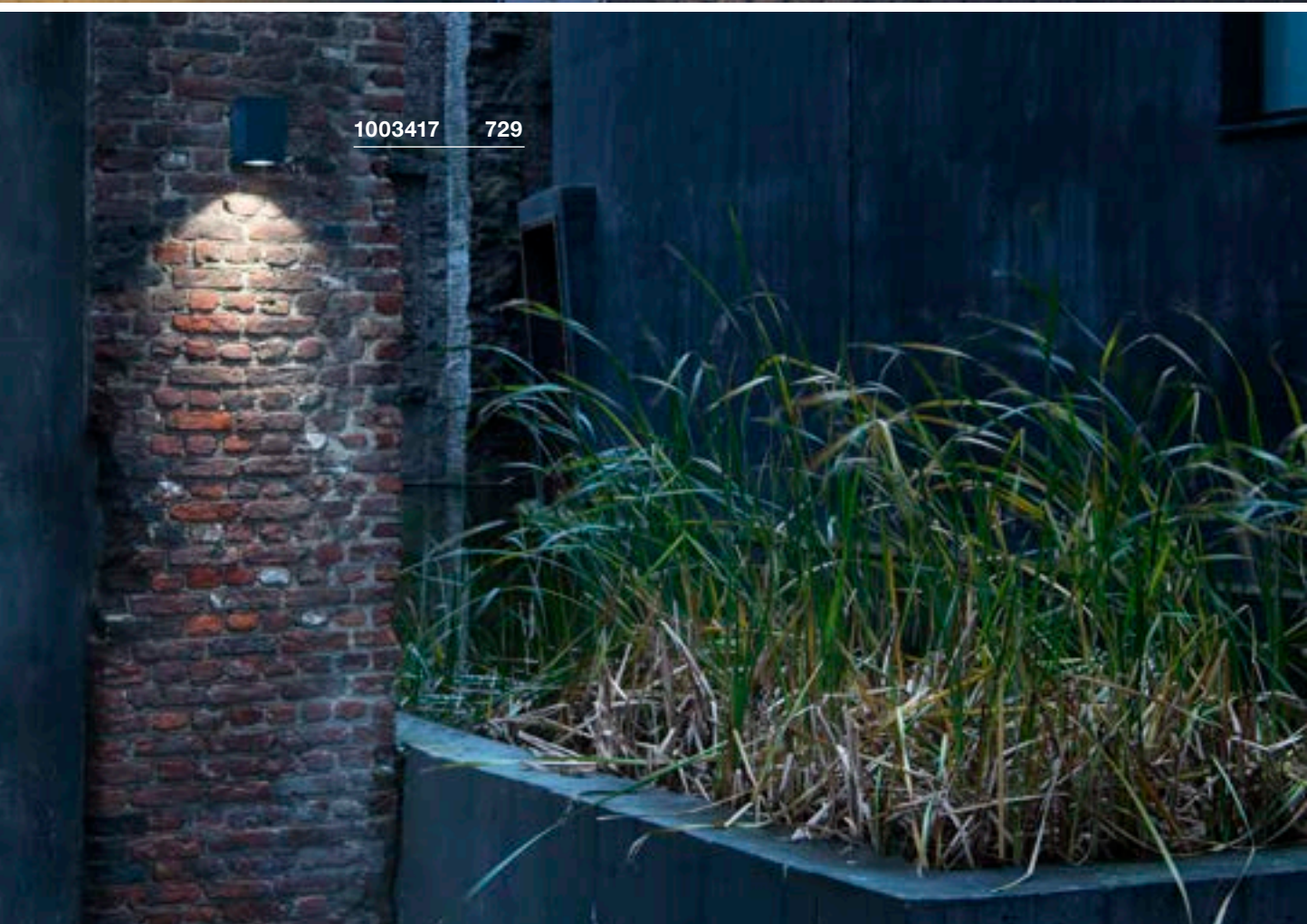

1003417 729



ENOLA CARRÉ S WL, simple

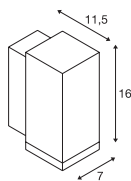

100-240V ~50/60Hz | 500mA
Puissance totale : 6W
Matière : aluminium / verre



Down 450lm | 3000K | 500lm | 4000K

Coloris	Ref.	CHF
● anthracite	1003416	259.00



Article	Ref.	CHF
Entretoises		
● anthracite	1002853	10.60
Réflecteur 60°		
● chrome	1005262	20.20

ENOLA CARRÉ M WL, simple

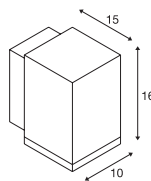

220-240V ~50/60Hz | 500mA
Puissance totale : 11W
Matière : aluminium / verre



Down 860lm | 3000K | 980lm | 4000K

Coloris	Ref.	CHF
● anthracite	1003417	319.00



Article	Ref.	CHF
Entretoises		
● anthracite	1002853	10.60
Lentille 19°		
● noir / chrome	1005205	52.00
Lentille asymétrique		
● noir / chrome	1005206	52.00
Réflecteur 60°		
● chrome	1005207	29.90

ENOLA CARRÉ L WL, simple

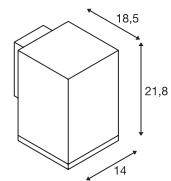

220-240V ~50/60Hz | 900mA
Puissance totale : 36W
Matière : aluminium / verre



Down 3300lm | 3000K | 3700lm | 4000K

Coloris	Ref.	CHF
● anthracite	1003437	379.00



Article	Ref.	CHF
Entretoises		
● anthracite	1002853	10.60
Réflecteur 60°		
● chrome	1005263	27.70

ENOLA CARRÉ S UP/DOWN WL

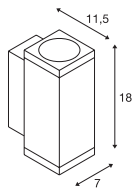

220-240V ~50/60Hz | 350mA
Puissance totale : 7,8W
Matière : aluminium / verre



Up	310lm	3000K	350lm	4000K
Down	310lm	3000K	350lm	4000K

Coloris	Ref.	CHF
● anthracite	1003418	319.00



Article	Ref.	CHF
Entretoises		
● anthracite	1002853	10.60
Réflecteur 60°		
● chrome	1005262	20.20

ENOLA CARRÉ M UP/DOWN WL

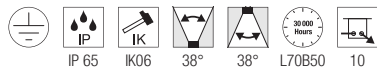
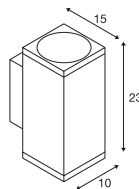

220-240V ~50/60Hz | 500mA
Puissance totale : 20W
Matière : aluminium / verre



Up	830lm	3000K	950lm	4000K
Down	830lm	3000K	950lm	4000K

Coloris	Ref.	CHF
● anthracite	1003419	379.00



Article	Ref.	CHF
Entretoises		
● anthracite	1002853	10.60
Lentille 19°		
● noir / chrome	1005205	52.00
Lentille asymétrique		
● noir / chrome	1005206	52.00
Réflecteur 60°		
● chrome	1005207	29.90

ENOLA CARRÉ L UP/DOWN WL

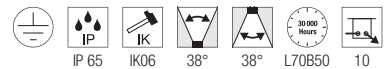
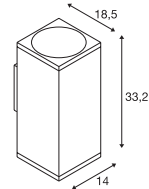

220-240V ~50/60Hz | 700mA
Puissance totale : 55W
Matière : aluminium / verre



Up	2700lm	3000K	3000lm	4000K
Down	2700lm	3000K	3000lm	4000K

Coloris	Ref.	CHF
● anthracite	1003438	520.00



Article	Ref.	CHF
Entretoises		
● anthracite	1002853	10.60
Réflecteur 60°		
● chrome	1005263	27.70



ENOLA S, M, L

Réflecteur 56°



60°

S | H : 1,85 cm Ø : 4,5 cm
 M | H : 4,00 cm Ø : 7,5 cm
 L | H : 6,96 cm Ø : 11 cm
 Matière : polycarbonate (PC)



ENOLA M

Lentille 19°



34 / 12°

H : 3,8 cm
 Ø : 7,5 cm
 Matière : acier / polycarbonate (PC)



ENOLA M

Lentille asymétrique



48 / 23°

H : 3 cm
 Ø : 7,5 cm
 Matière : acier / polycarbonate (PC)



Coloris	Ref.	CHF
● chrome S	1005262	20.20
● chrome M	1005207	29.90
● chrome L	1005263	27.70

Coloris	Ref.	CHF
●● noir / chrome	1005205	52.00

Coloris	Ref.	CHF
●● noir / chrome	1005206	52.00



EASY TO INSTALL

1

MONTAGE AU MUR.

Vissez la plaque de montage dans le mur à l'aide des vis de fixation.

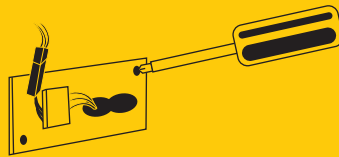

2

BRANCHEMENT FACILE.

Reliez le connecteur d'alimentation électrique aux luminaires LED.

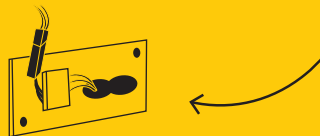

3

ASSEMBLAGE PROPRE ET SÛR.

Accrochez le luminaire dans la rainure de guidage de la plaque de montage et visser le corps du luminaire sur la plaque.



LE TOUR EST JOUÉ !

Parce que l'efficacité est toujours payante, les luminaires SLV sont faciles et rapides à installer en toute sécurité. Grâce à des plaques de montage détachables, des têtes de luminaires amovibles, des raccordements par borniers à clip et des câblages passants. Vous économisez du temps, des efforts et de l'argent.

FIXATION DES TÊTES DE LAMPE

Dans notre famille ENOLA® également, la tête du luminaire peut être séparée de la plaque de montage fixée au mur. Ainsi, après la fixation de la plaque de montage et le raccordement électrique via le bornier de connexion à clip, les deux mains restent libres pour visser le luminaire en toute sécurité.

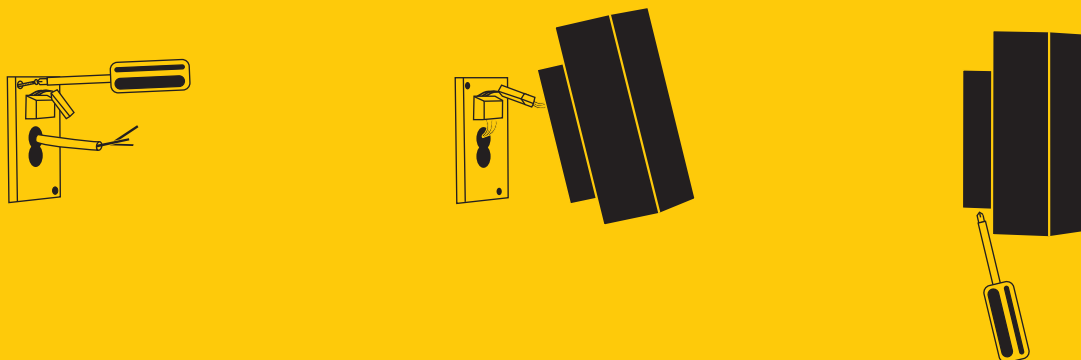

BORNIERS À RESSORTS PRATIQUES.

Les appliques SITRA CUBE séduisent par leur sobriété moderne. Elles sont également rapides et faciles à installer : il suffit de brancher les câbles, directement et sans outil, et de raccorder la plaque de montage à la fiche du luminaire – Terminé !



Branchement du
câble électrique

Il n'y a plus qu'à
assembler

CÂBLAGE CONTINU.

Nos appliques et plafonniers QUADRULO montrent la simplicité de fonctionnement du câblage continu dans la pratique. En effet, le socle du luminaire est doté de deux passages de câbles en forme de 8. Le bornier à ressort est aussi équipé de deux points de raccordement. Il est ainsi possible d'installer plusieurs luminaires très facilement.

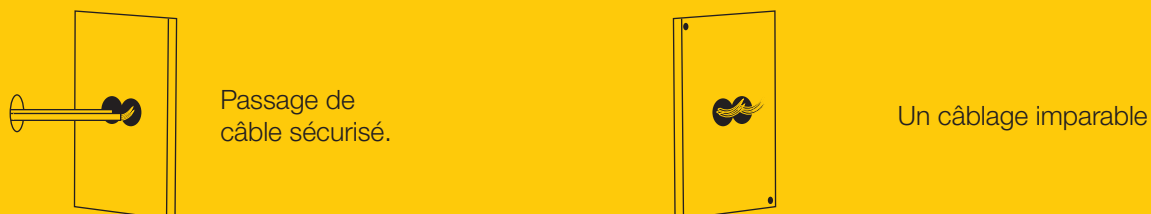

Passage de
câble sécurisé.

Un câblage imparable



229532 735



234515 735



THEO UP/DOWN
WL, QPAR51

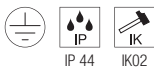
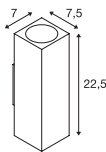

220-240V ~50/60 Hz
Matière : aluminium / verre



Douilles : 2xGU10

Coloris	Ref.	CHF
● anthracite	229535	128.00
○ blanc	229531	128.00
● gris	229532	128.00



LED GU10 51mm | 6W | 38°
2700K | 450lm | CEE=F
6kWh / 1000h



Ref. : 1005077 | 10.60 CHF

BIG THEO BEAM UP/
FLOOD DOWN
WL

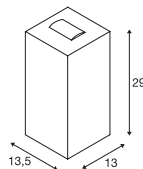

220-240V ~50/60Hz | 500mA
Puissance totale : 29W
Matière : aluminium / verre



Up 130lm | 3000K
Down 2000lm | 3000K

Coloris	Ref.	CHF
● anthracite	234515	345.00

BIG THEO UP/DOWN
WL, QPAR111

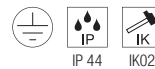
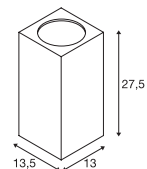

220-240V ~50/60 Hz
Matière : aluminium / verre



Douilles : 2xGU10

Coloris	Ref.	CHF
● anthracite	229575	219.00
● gris	229574	219.00



QPAR111 | 12,5W | 10°
3000K | 950lm | CEE=F
13kWh / 1000h



Ref. : 1005278 | 65.00 CHF

BIG THEO FLOOD UP/DOWN
WL

THEO
WL, QPAR51

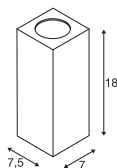
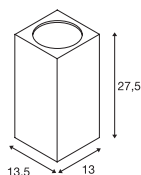

220-240V ~50/60Hz | 1000mA
Puissance totale : 42W
Matière : aluminium / verre



Up 2000lm | 3000K
Down 2000lm | 3000K

Coloris	Ref.	CHF
● anthracite	234505	359.00



220-240V ~50/60 Hz
Matière : aluminium / verre



Douille : 1xGU10

Coloris	Ref.	CHF
● anthracite	229525	117.00
● gris	229524	117.00

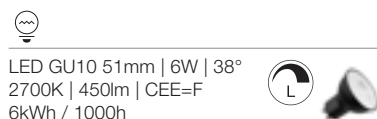

LED GU10 51mm | 6W | 38°
2700K | 450lm | CEE=F
6kWh / 1000h

Ref. : 1005077 | 10.60 CHF



234505 736





BIG THEO WL, QPAR111

BIG THEO WL

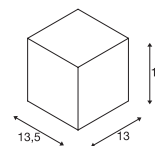
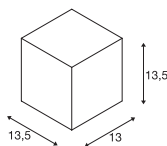

IP 44

220-240V ~50/60 Hz
Matière : aluminium / verre



Douille : 1xGU10

Coloris	Ref.	CHF
● anthracite	229565	149.00
● gris	229564	149.00



QPAR111 | 12,5W | 10°
3000K | 950lm | CEE=F
13kWh / 1000h



Ref. : 1005278 | 65.00 CHF



100-277V ~50/60Hz | 500mA
Puissance totale : 21W
Matière : aluminium / verre



Down

2000lm | 3000K

Coloris	Ref.	CHF
● anthracite	234525	259.00

234525 737



1002032 739



SITRA S

WL, simple, carré

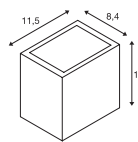

100-277V ~50/60Hz | 500mA
Puissance totale : 11W
Matière : aluminium



Up	550lm	3000K	635lm	4000K
Down	550lm	3000K	635lm	4000K

Coloris	Ref.	CHF
● anthracite	1002032	149.00
○ blanc	1002033	149.00
● rouille	1002034	149.00

SITRA S

WL, simple, carré

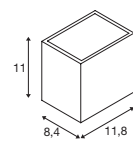

220-240V ~50/60Hz | 500mA
Puissance totale : 6,2W
Matière : aluminium / verre



Down	580lm	3000K	620lm	4000K
------	-------	-------	-------	-------

Coloris	Ref.	CHF
● anthracite	1005148	117.00
○ blanc	1005149	117.00
● rouille	1005150	117.00



232531 741

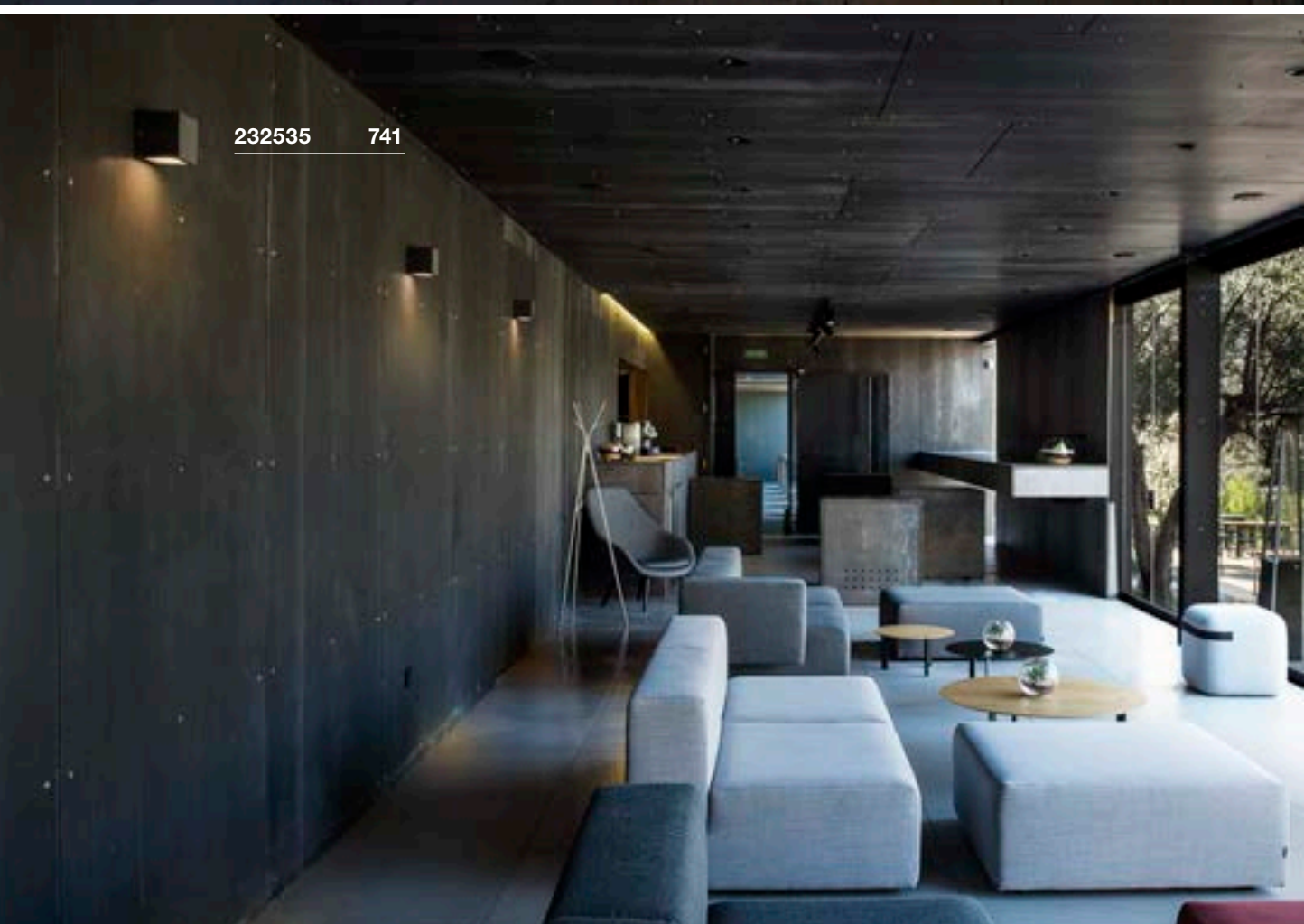

232535 741



SITRA M
WL, up/down, carré

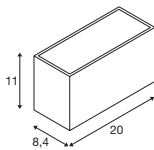

220-240V ~50/60Hz | 350mA
Puissance totale : 14W
Matière : aluminium



Up	850lm	3000K	940lm	4000K
Down	850lm	3000K	940lm	4000K

Coloris	Ref.	CHF
● anthracite		
1700 / 1880lm	1005151	172.00
○ blanc		
1700 / 1880lm	1005153	172.00
● rouille		
1600 / 1700lm	1005154	172.00

SITRA L
WL, up/down, carré

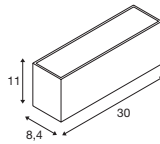

220-240V ~50/60Hz | 600mA
Puissance totale : 24W
Matière : aluminium



Up	1400lm	3000K	1530lm	4000K
Down	1400lm	3000K	1530lm	4000K

Coloris	Ref.	CHF
● anthracite	1005155	219.00
○ blanc	1005156	219.00
● rouille	1005157	219.00

SITRA CUBE
WL, TCR-TSE

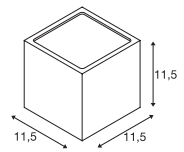

220-240V ~50/60 Hz
Matière : aluminium / verre



Douilles : 2xGX53 Ø max. : 7,5 cm L : 2,7 cm

Coloris	Ref.	CHF
● anthracite	232535	99.00
○ blanc	232531	99.00
● rouille	232537	99.00



LED GX53 | 6,1W | 120°
3000K | 490lm | CEE=G
6kWh / 1000h



Ref. : **1005271** | **13.50 CHF**

GRAFIT
WL, rond, Sensor, E27

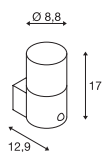

GRAFIT
WL, rond, E27

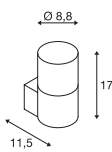

220-240V ~50/60 Hz
Matière : aluminium / acrylique



Douille : 1xE27 Ø max. : 6 cm L : 11,5 cm

Coloris	Ref.	CHF
● anthracite	1006179	102.00



LED E27 | 8W | 240°
3000K | 880lm | CEE=E
8kWh / 1000h



Ref. : 1005289 | 12.90 CHF



220-240V ~50/60 Hz
Matière : aluminium / acrylique



Douille : 1xE27 Ø max. : 6 cm L : 11,5 cm

Coloris	Ref.	CHF
● anthracite	1006178	102.00



A60 | 7,5W | 320°
2700K | 800lm | CEE=F
8kWh / 1000h



Ref. : 1005303 | 12.90 CHF



1006178 742





GRAFIT
WL, carré, Sensor, E27

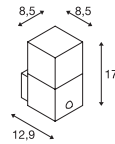

GRAFIT
WL, carré, E27

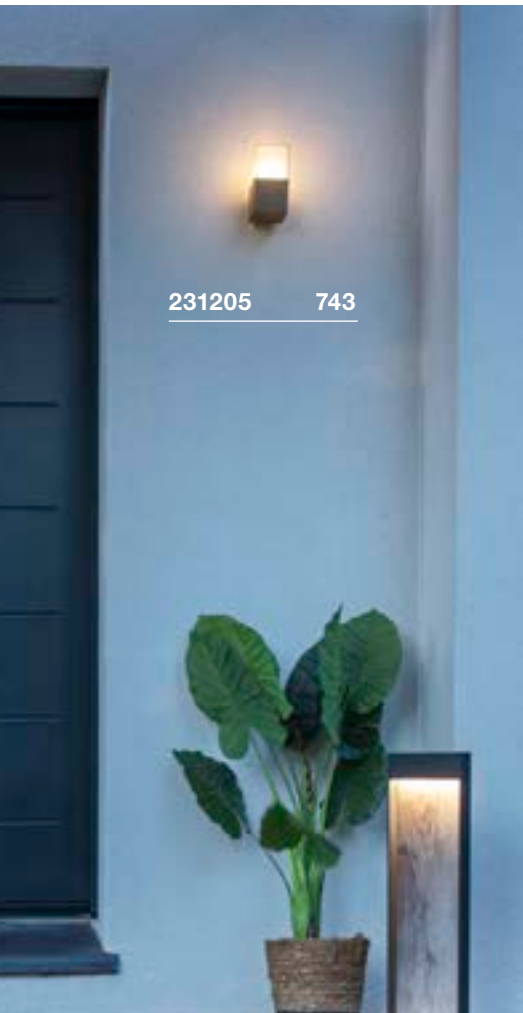
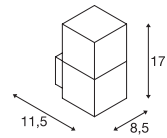

231205 743



IP 44

220-240V ~50/60 Hz
Matière : aluminium / acrylique



Douille : 1xE27 Ø max. : 6 cm L : 11,5 cm

Coloris	Ref.	CHF
● anthracite	1006183	102.00



A60 | 7,5W | 320°
2700K | 800lm | CEE=F
8kWh / 1000h



Ref. : 1005303 | 12.90 CHF



IP 44

220-240V ~50/60 Hz
Matière : aluminium / plastique



Douille : 1xE27 Ø max. : 6 cm L : 11,5 cm

Coloris	Ref.	CHF
● anthracite	231205	99.00



A60 | 7,5W | 320°
2700K | 800lm | CEE=F
8kWh / 1000h



Ref. : 1005303 | 12.90 CHF

QUADRULO WL



NEW

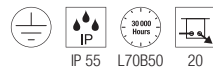
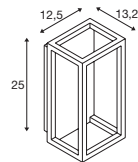

100-277V ~50/60Hz | 350mA
Puissance totale : 7,4W
Matière : aluminium /
polychlorure de vinyle (PVC)



Down 270lm | 3000K
280lm

Coloris	Ref.	CHF
● anthracite 270lm	1005201	209.00
● anthracite / bois 280lm	1007207 ●	185.00



1002402 745

QUADRULO SENSOR
WL, E27

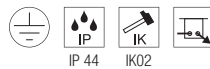
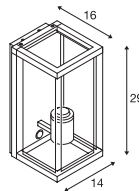

220-240V ~50/60 Hz
Matière : aluminium / verre



Douille : 1xE27 Ø max. : 8 cm L : 18 cm

Coloris	Ref.	CHF
● anthracite	1002402	209.00



LED E27 | 7,5W | 320°
2500K | 700lm | CEE=F
8kWh / 1000h



Ref. : 1005265 | 33.00 CHF

QUADRULO
WL, E27

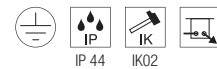
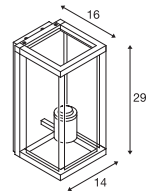

220-240V ~50/60 Hz
Matière : aluminium / verre



Douille : 1xE27 Ø max. : 8 cm L : 18 cm

Coloris	Ref.	CHF
● anthracite	1002403	192.00



LED E27 | 7,5W | 320°
2500K | 700lm | CEE=F
8kWh / 1000h



Ref. : 1005265 | 33.00 CHF



1002403 745

MERIDIAN
WL, E27

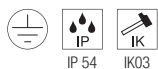
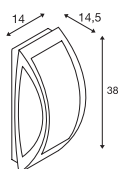

220-240V ~50/60 Hz
Matière : aluminium / polycarbonate (PC)



Douille : 1xE27 Ø max. : 7 cm L : 17,5 cm

Coloris	Ref.	CHF
● anthracite	230445	96.00
● gris	230444	96.00



LED E27 | 8W | 240°
3000K | 880lm | CEE=E
8kWh / 1000h



Ref. : 1005289 | 12.90 CHF

MERIDIAN BOX
WL, E27

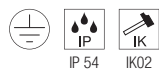
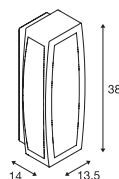

220-240V ~50/60 Hz
Matière : aluminium / polycarbonate (PC)



Douille : 1xE27 Ø max. : 7 cm L : 17,5 cm

Coloris	Ref.	CHF
● anthracite	230045	128.00
● gris	230044	128.00



| 13,5W | 240°
4000K | 1600lm | CEE=E
14kWh / 1000h



Ref. : 1005308 | 13.80 CHF





230445 746

MERIDIAN BOX SENSOR
WL, E27

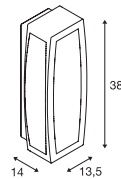

220-240V ~50/60 Hz
Matière : aluminium / polycarbonate (PC)

- La luminosité d'activation et la durée d'éclairage peuvent être programmées.



Douille : 1xE27 Ø max. : 7 cm L : 17,5 cm

Coloris	Ref.	CHF
● anthracite	230085	209.00
● gris	230084	209.00



LED E27 | 8W | 240°
3000K | 880lm | CEE=E
8kWh / 1000h



Ref. : 1005289 | 12.90 CHF

MERIDIAN BOX
WL, E27

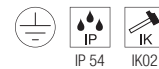
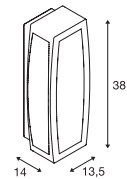

220-240V ~50/60 Hz
Matière : aluminium / polycarbonate (PC)



Douille : 1xE27 Ø max. : 7 cm L : 17,5 cm

Coloris	Ref.	CHF
● anthracite	230655	138.00
● rouille	230657	138.00



LED E27 | 7,5W | 320°
2500K | 700lm | CEE=F
8kWh / 1000h



Ref. : 1005265 | 33.00 CHF



230655 747

1004748 749

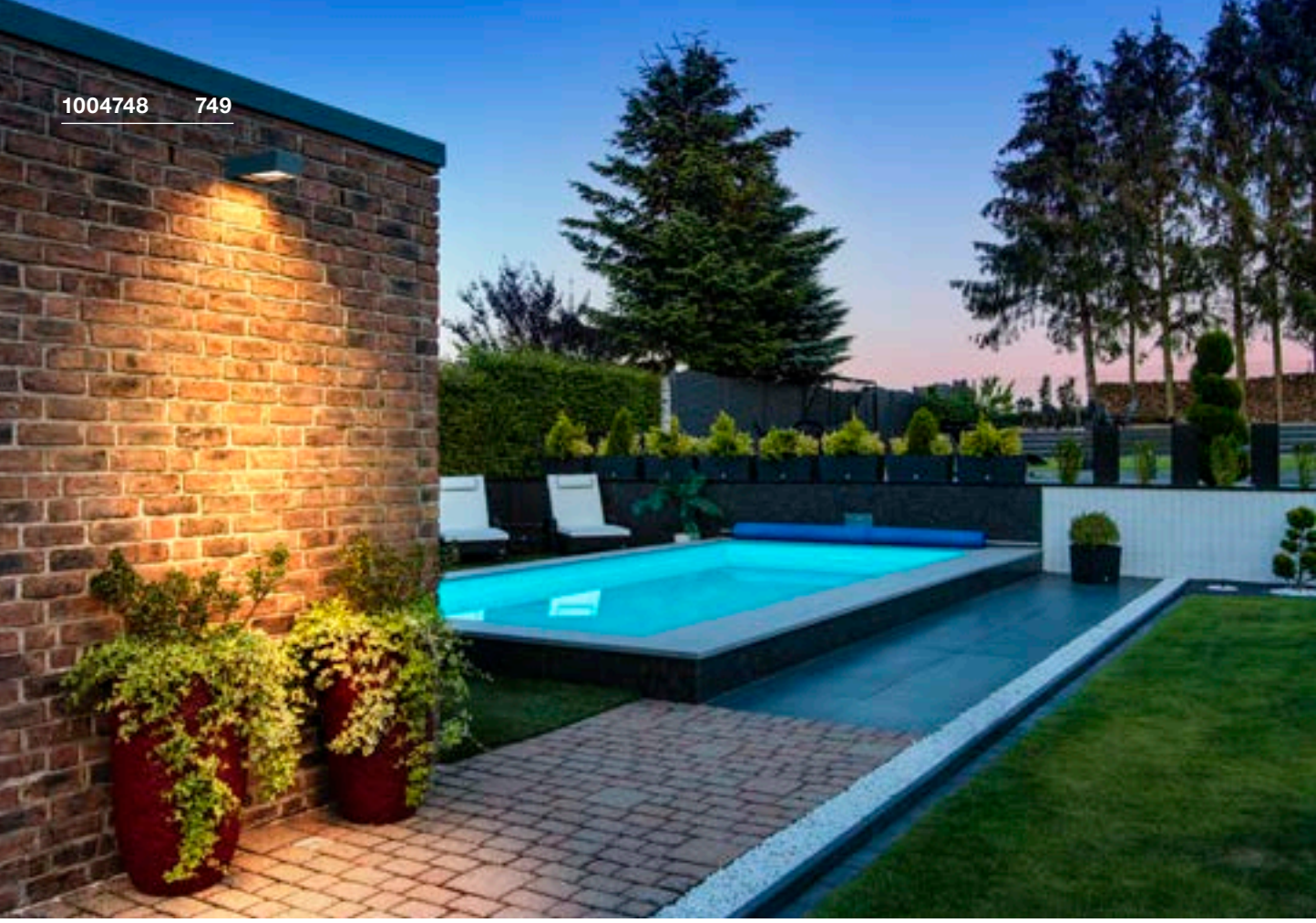

1006314 749

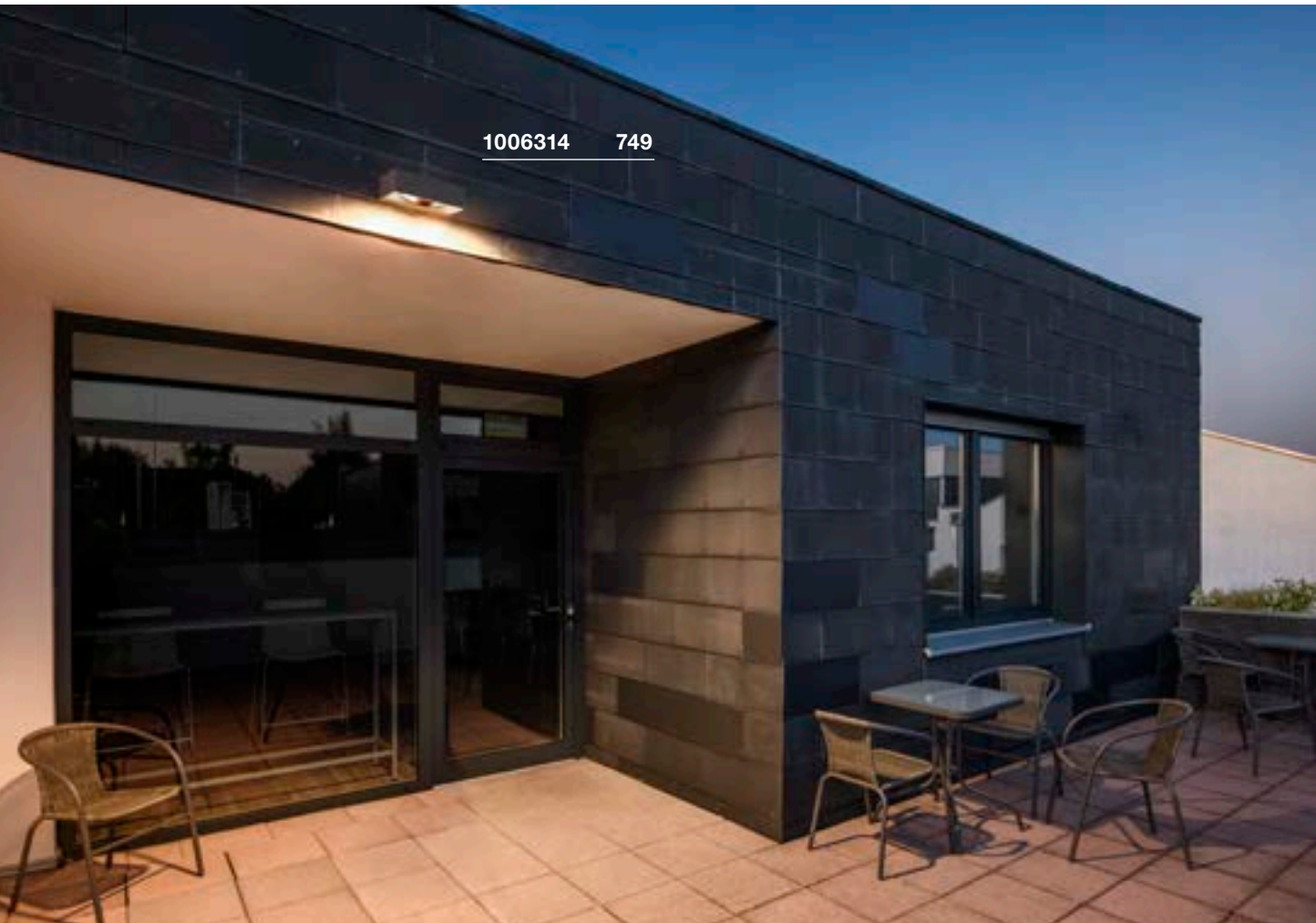



ESKINA FRAME WL

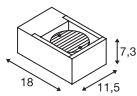

220-240V ~50/60Hz | 350mA
Puissance totale : 15W
Matière : aluminium



Down	1100lm 3000K	1200lm 4000K
------	----------------	----------------

Coloris	Ref.	CHF
● anthracite	1004747	245.00

ESKINA FRAME WL, double

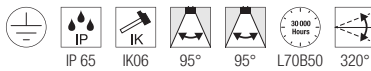
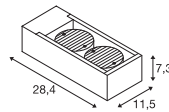

220-240V ~50/60Hz | 700mA
Puissance totale : 27W
Matière : aluminium



Spot 1	1100lm 3000K	1200lm 4000K
Spot 2	1100lm 3000K	1200lm 4000K

Coloris	Ref.	CHF
● anthracite	1004748	309.00

ESKINA FRAME WL, double

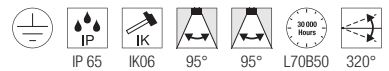
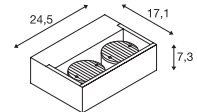

220-240V ~50/60Hz | 700mA
Puissance totale : 27W
Matière : aluminium



Spot 1	1100lm 3000K	1200lm 4000K
Spot 2	1100lm 3000K	1200lm 4000K

Coloris	Ref.	CHF
● anthracite	1006314	329.00

1005443 751

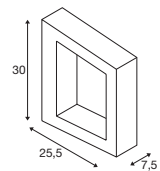

**BOOKAT
WL****1005441 683**

100-277V ~50/60Hz | 700mA
 Puissance totale : 15W
 Matière : aluminium



Down 920lm | 3000K | 990lm | 4000K

Coloris	Ref.	CHF
● anthracite	1005443	219.00

BIG QUAD
WL

QUAD
WL

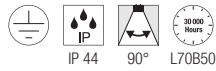
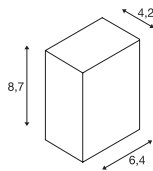
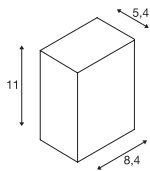

100-240V ~50/60Hz | 350mA
Puissance totale : 4,5W
Matière : aluminium / verre

200-240V ~50/60Hz | 700mA
Puissance totale : 4,6W
Matière : aluminium / verre



Down 260lm | 3000K



Down 80lm | 3000K
100lm | 3000K

Coloris	Ref.	CHF
● anthracite	232435	160.00

Coloris	Ref.	CHF
● anthracite	232465	117.00
○ blanc	232461	117.00

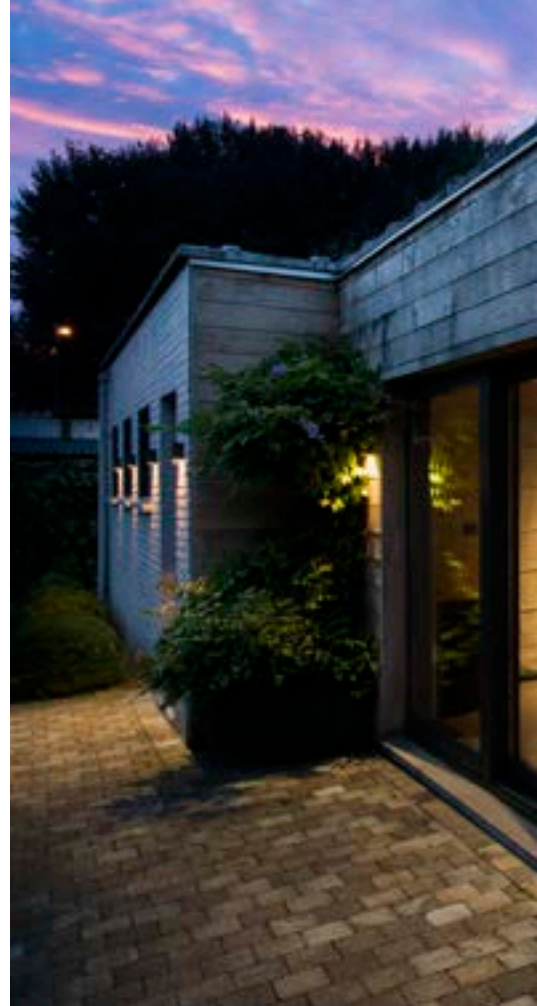



QUAD UP/DOWN 15 WL

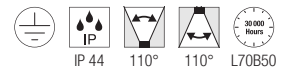
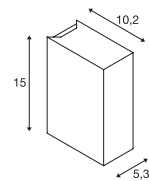

100-277V ~50/60Hz | 350mA
Puissance totale : 8W
Matière : aluminium / verre



Up 260lm | 3000K
Down 260lm | 3000K

Coloris	Ref.	CHF
● anthracite 520lm	232445	202.00
○ blanc 580lm	232441	202.00

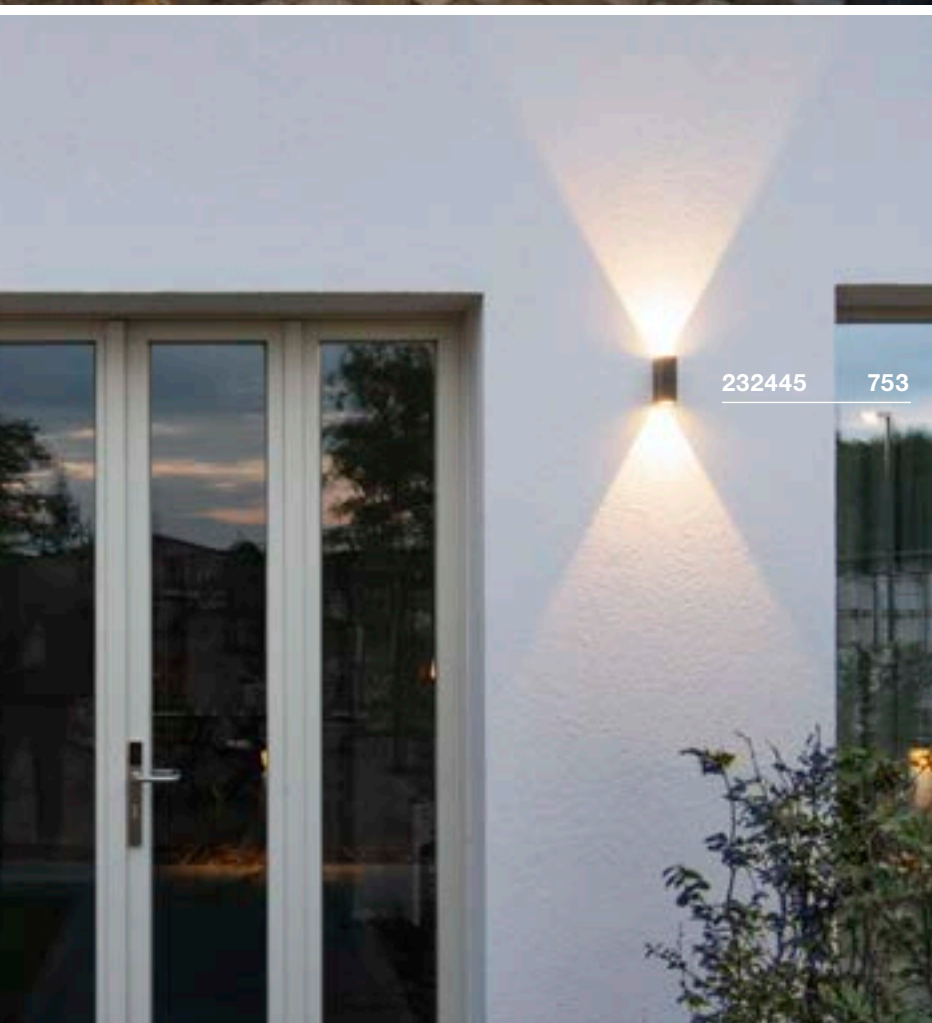

1005126 755

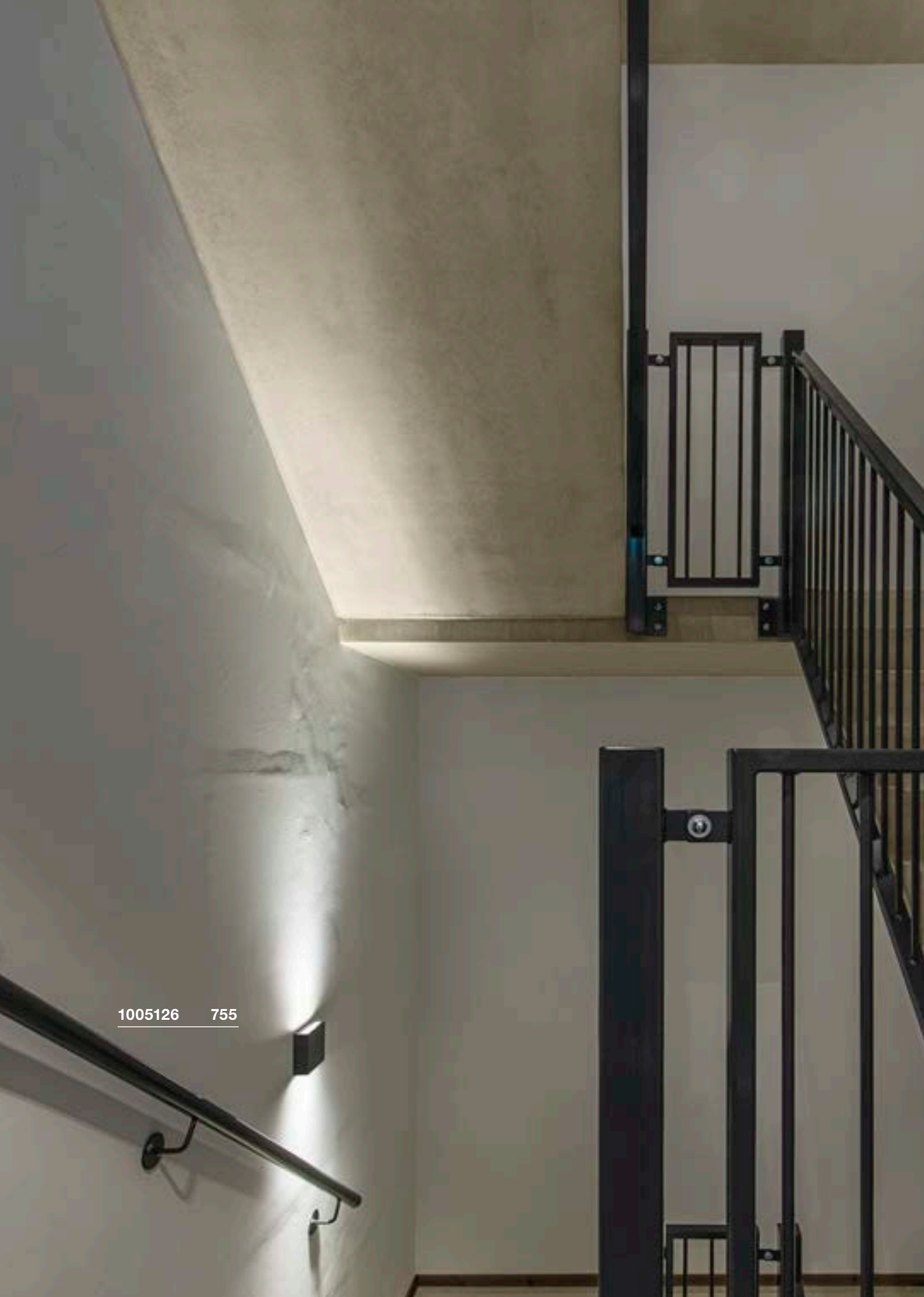



BIG QUAD UP/DOWN WL

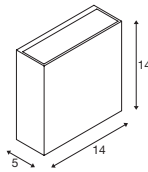

220-240V ~50/60Hz | 500mA
 Puissance totale : 8,2W
 Matière : aluminium / verre



Up 320lm | 3000K
 Down 320lm | 3000K

Coloris	Ref.	CHF
● anthracite	1005126	209.00
○ blanc	1005125	209.00

BIG QUAD WL

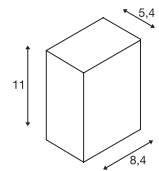

100-240V ~50/60Hz | 350mA
 Puissance totale : 4,5W
 Matière : aluminium / verre



Down 290lm | 3000K

Coloris	Ref.	CHF
○ blanc	232431	160.00

RUSTY® UP/DOWN
WL, carré

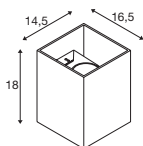

220-240V ~50/60Hz | 350mA
Puissance totale : 14W
Matière : acier FeCSi / aluminium



Up	259lm	3000K	260lm	4000K
Down	285lm	3000K	288lm	4000K

Coloris	Ref.	CHF
● rouille / anthracite	1004650	329.00

RUSTY® UP/DOWN
WL, rond

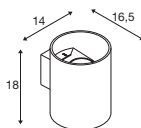

220-240V ~50/60Hz | 350mA
Puissance totale : 14W
Matière : acier FeCSi / aluminium



Up	249lm	3000K	254lm	4000K
Down	267lm	3000K	271lm	4000K

Coloris	Ref.	CHF
● rouille / anthracite	1004651	329.00

1004650 756

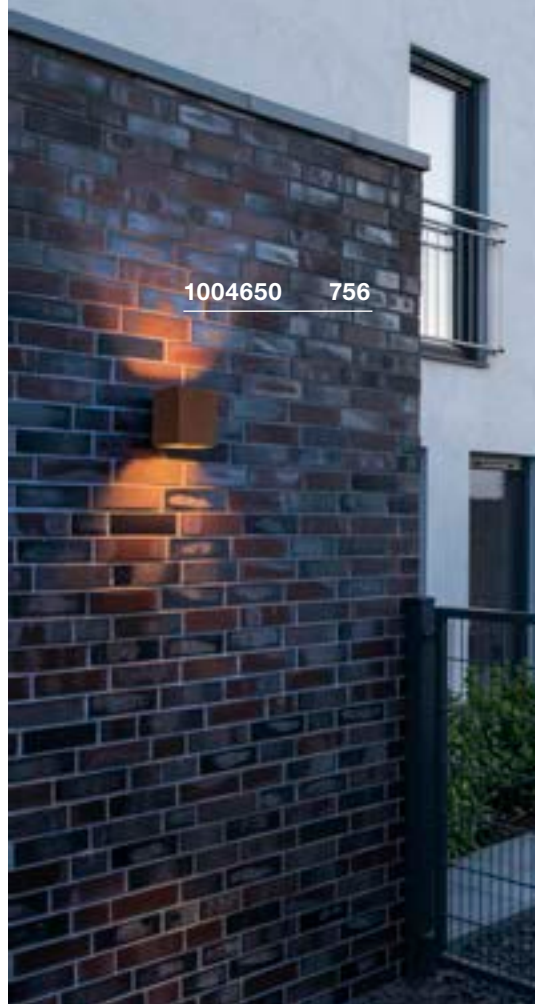



OVALISK SENSOR WL

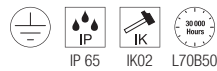
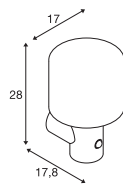

220-240V ~50/60Hz | 500mA
Puissance totale : 9,6W
Matière : aluminium / verre



Down 580lm | 3000K | 630lm | 4000K

Coloris	Ref.	CHF
● anthracite	1004679	329.00

OVALISK WL

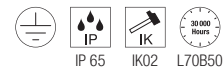
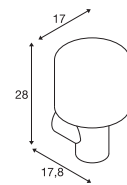

220-240V ~50/60Hz | 500mA
Puissance totale : 9,2W
Matière : aluminium / verre



Down 580lm | 3000K | 630lm | 4000K

Coloris	Ref.	CHF
● anthracite	1004678	309.00



1004679 757

PEMA®
WL

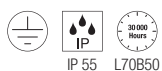
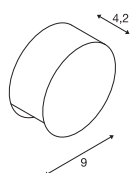
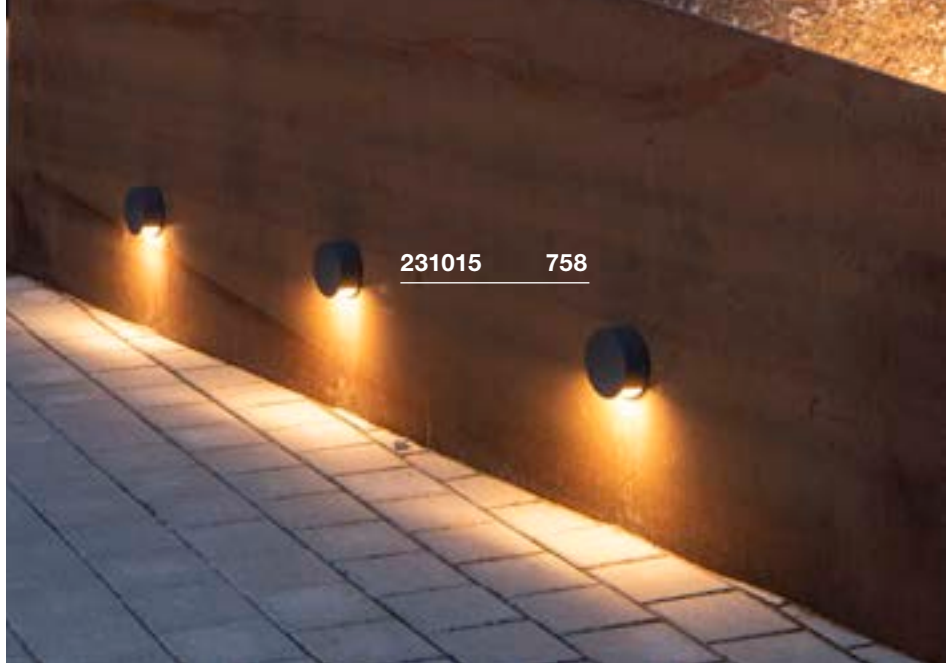

220-240V ~50/60 Hz
Puissance totale : 3,8W
Matière : aluminium / polycarbonate (PC)

- Protection IP55 uniquement en cas de montage avec le faisceau vers le bas.



Down 170lm | 3000K

Coloris	Ref.	CHF
● anthracite	231015	138.00
○ blanc	231010	138.00
● gris	231012	138.00

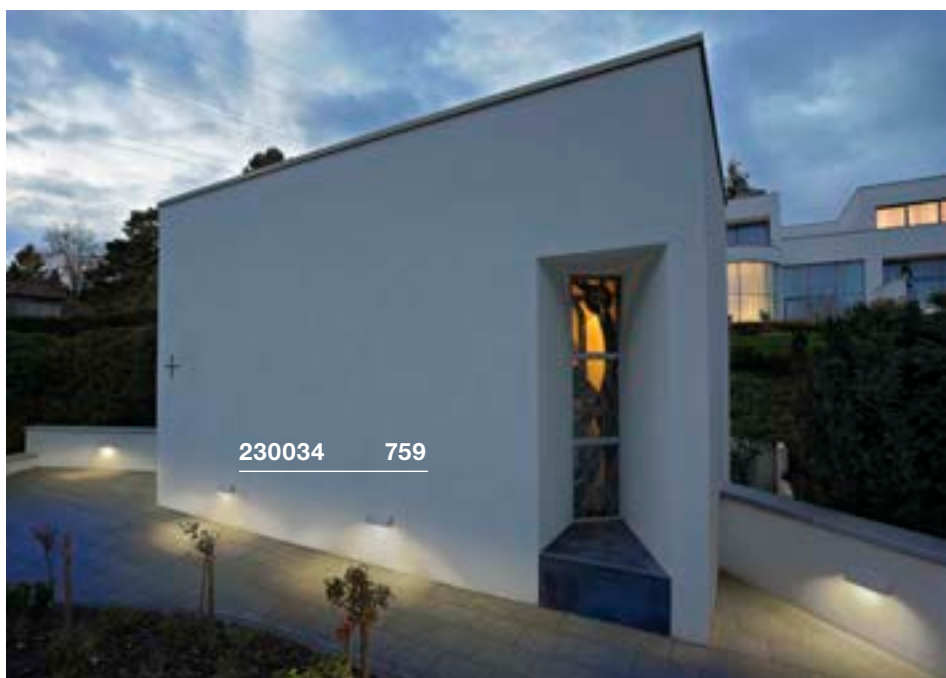
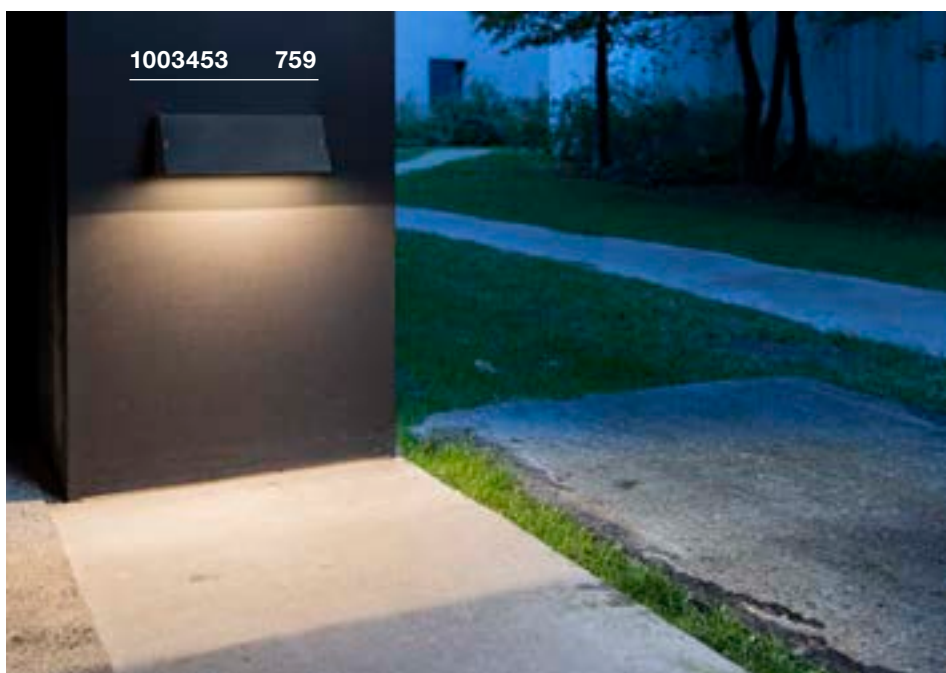



PEMA®
WL

PEMA®
WL

PEMA®
WL, E27

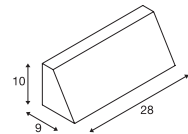
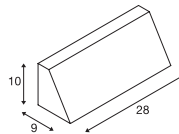
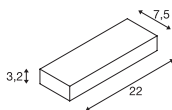

220-240V ~50/60 Hz
Puissance totale : 7,7W
Matière : aluminium / verre



100-277V ~50/60Hz | 350mA
Puissance totale : 14W
Matière : aluminium / verre

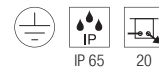

220-240V ~50/60 Hz
Matière : aluminium / verre



Down 640lm | 3000K



Down 1340lm | 3000K | 1420lm | 4000K



Douille : 1xE27 Ø max. : 4,5 cm | L : 21 cm

Coloris	Ref.	CHF
● anthracite	1002069	160.00
○ blanc	1002070	160.00

Coloris	Ref.	CHF
● noir	1003453	175.00
● gris	1003454	175.00

Coloris	Ref.	CHF
● noir	230030	124.00
● gris	230034	124.00



LED E27 | 8W | 240°
3000K | 880lm | CEE=E
8kWh / 1000h



Ref. : 1005289 | 12.90 CHF

FLATT SENSOR WL

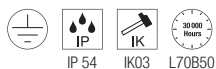
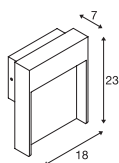

100-240V ~50/60Hz | 300mA
Puissance totale : 13W
Matière : aluminium / aluminium



Down 500lm | 3000K | 550lm | 4000K

Coloris	Ref.	CHF
● anthracite 500 / 530lm	1002954	239.00
●● anthracite / marron 500 / 550lm	1002955	239.00

FLATT WL

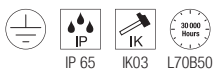
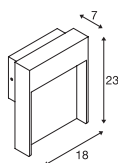

100-240V ~50/60Hz | 300mA
Puissance totale : 13W
Matière : aluminium / aluminium



Down 500lm | 3000K | 530lm | 4000K

Coloris	Ref.	CHF
● anthracite 500 / 530lm	1002952	209.00
●● anthracite / marron 500 / 550lm	1002953	209.00





1002955 760



ASTINA
WL, QPAR51

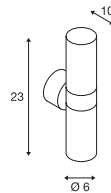

220-240V ~50/60 Hz
Matière : aluminium / verre

ASTINA STEEL
WL, QPAR51

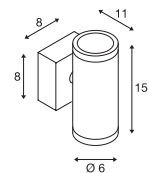

220-240V ~50/60 Hz
Matière : acier inoxydable 304

228775 761

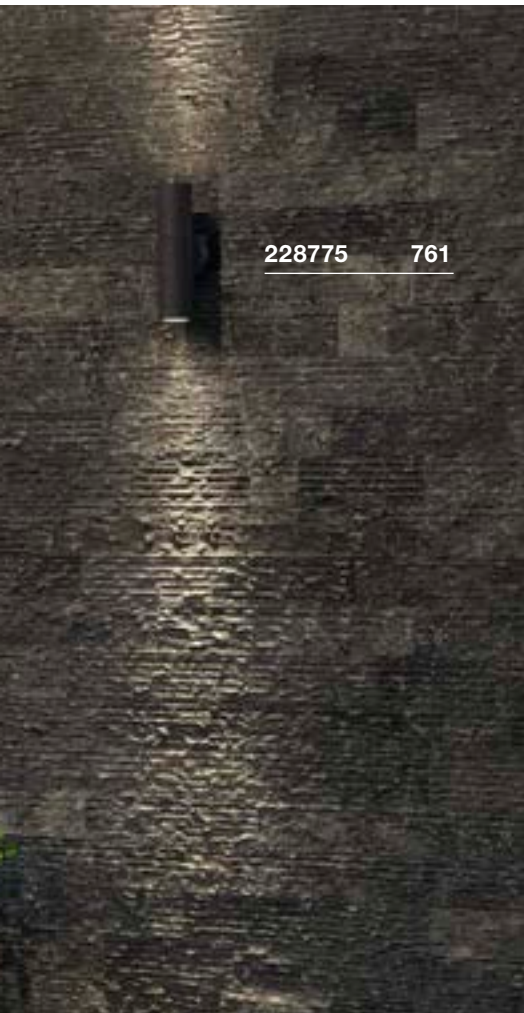

Douilles : 2xGU10 L max. : 9 cm

Coloris	Ref.	CHF
● anthracite	228775	102.00
○ blanc	228771	102.00
● alu brossé	228776	117.00



LED GU10 51mm | 6W | 38°
2700K | 450lm | CEE=F
6kWh / 1000h



Ref. : 1005075 | 10.60 CHF



Douilles : 2xGU10 Ø max. : 5,1 cm L : 5,7 cm

Coloris	Ref.	CHF
● inox	233302	149.00



LED GU10 51mm | 6W | 38°
2700K | 450lm | CEE=F
6kWh / 1000h



Ref. : 1005075 | 10.60 CHF

ANGOLUX SENSOR
WL

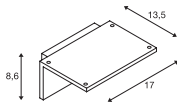

100-240V ~50/60Hz | 240mA
Puissance totale : 9,8W
Matière : aluminium

- Angle de détection 120°
distance de détection max. 9 m
sensibilité d'éclairage réglable
- Protection IP44 uniquement en cas de montage avec le faisceau vers le bas.



Down 750lm | 3000K

Coloris	Ref.	CHF
● anthracite	1001969	239.00
○ blanc	1001970	239.00

ANGOLUX
WL

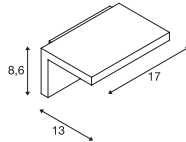

220-240V ~50/60Hz | 80mA
Puissance totale : 6,8W
Matière : aluminium

- Protection IP44 uniquement en cas de montage avec le faisceau vers le bas.



Down 550lm | 3000K

Coloris	Ref.	CHF
● anthracite	231355	192.00
○ blanc	231351	192.00

1001969 762

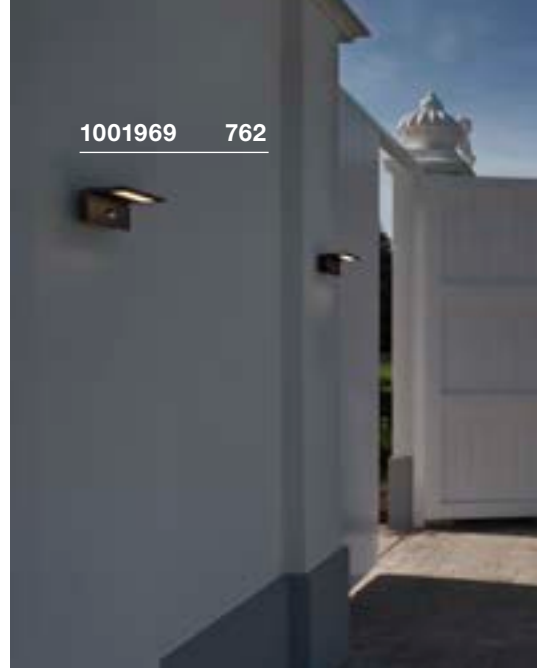

1002504 763

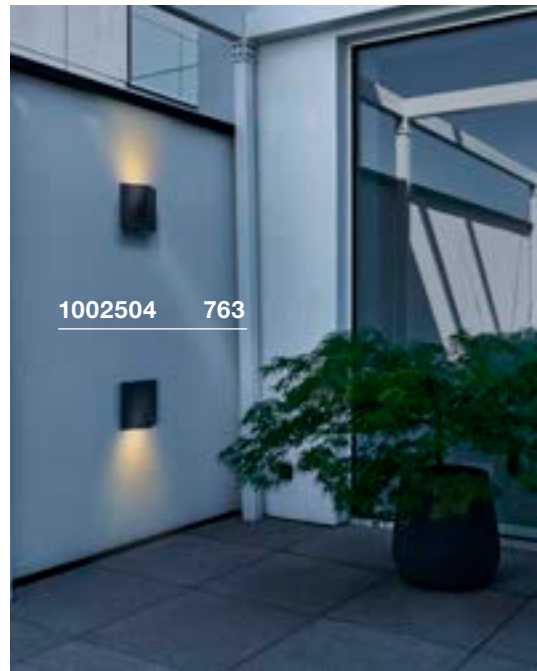

1002505 763

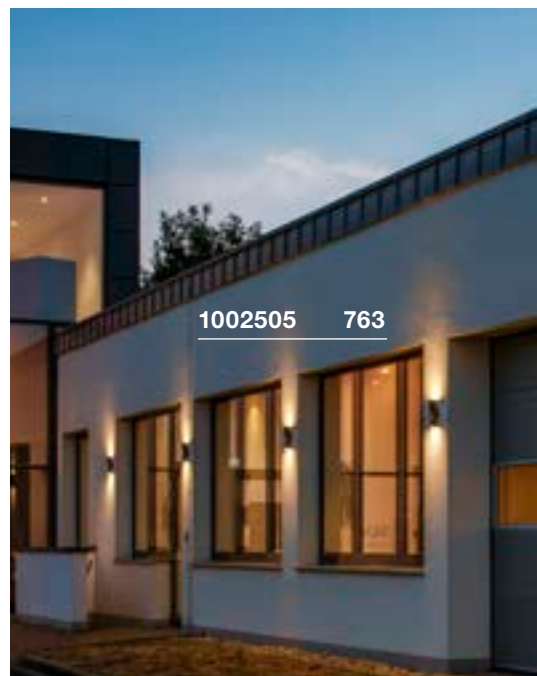



VILUA S
WL

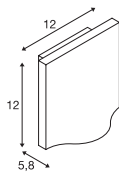

100-277V ~50/60Hz | 700mA
Puissance totale : 9W
Matière : aluminium / verre



Down 405lm | 3000K

Coloris	Ref.	CHF
● anthracite	1002503	193.00

VILUA L
WL

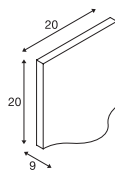

100-277V ~50/60Hz | 350mA
Puissance totale : 17W
Matière : aluminium / verre



Down 940lm | 3000K

Coloris	Ref.	CHF
● anthracite	1002504	245.00

VILUA
UP/DOWN, WL

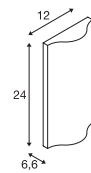

100-277V ~50/60Hz | 700mA
Puissance totale : 16W
Matière : aluminium / verre



Up 400lm | 3000K
Down 400lm | 3000K

Coloris	Ref.	CHF
● anthracite	1002505	245.00

MYRA UP/DOWN
WL, QPAR51

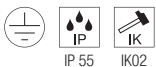
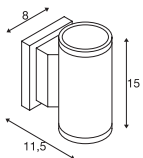

220-240V ~50/60 Hz
Matière : aluminium / verre



Douilles : 2xGU10 | Ø max. : 5,1 cm | L : 5,7 cm

Coloris	Ref.	CHF
● anthracite	233115	156.00
● gris	233114	156.00



LED GU10 51mm | 6W | 38°
2700K | 450lm | CEE=F
6kWh / 1000h



Ref. : 1005077 | 10.60 CHF



Article	Ref.	CHF
Cadre pour montage sur crépis		
● anthracite	233215	25.55
● gris	233214	27.70

233114 764

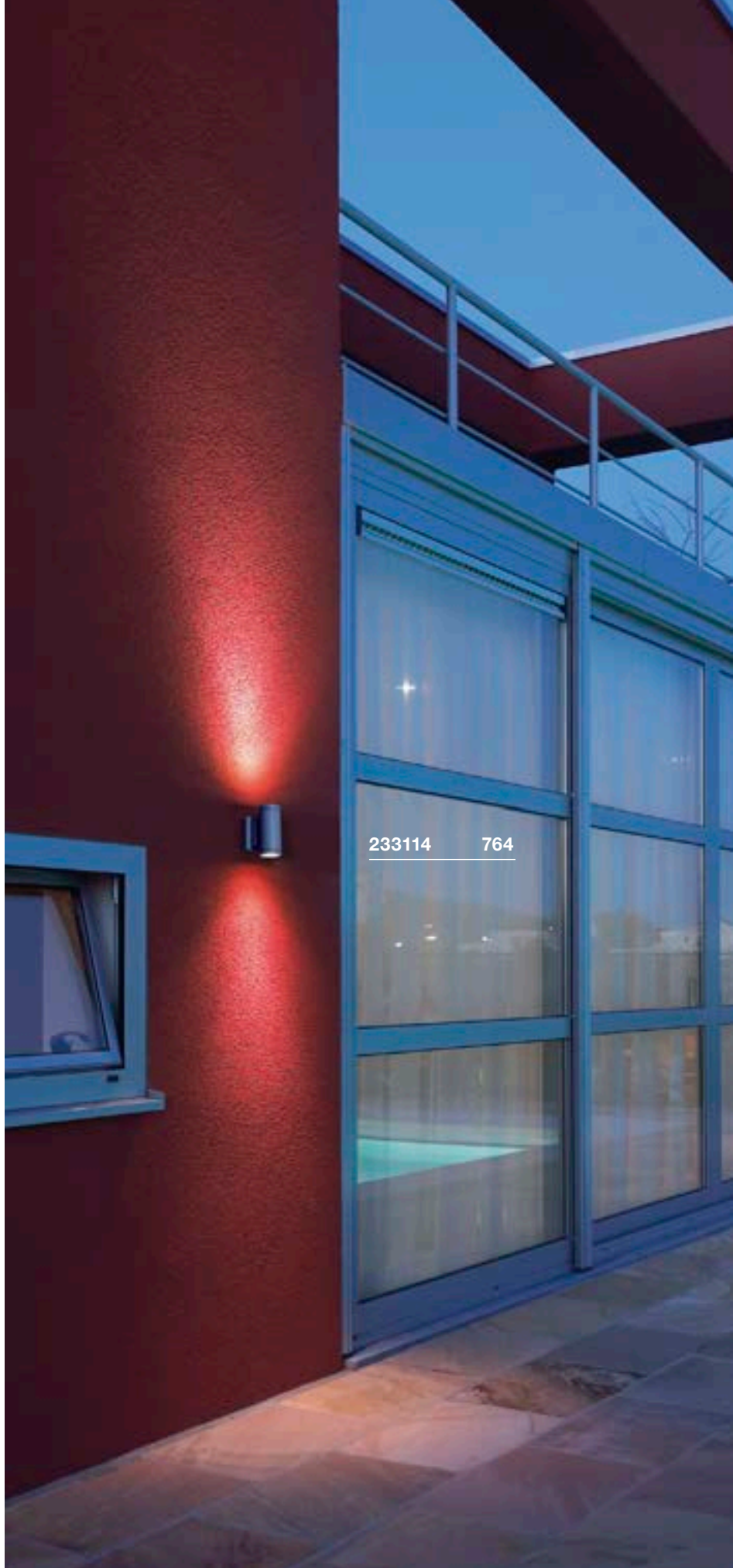



SITRA UP/DOWN
WL

SITRA UP/DOWN
WL, TCR-TSE

230362 765

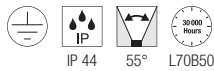
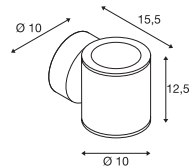
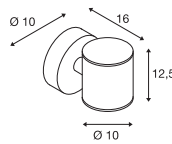

220-240V ~50/60 Hz
Puissance totale : 18W
Matière : aluminium / verre

220-240V ~50/60 Hz
Matière : aluminium / verre



Up 488lm | 3000K
Down 488lm | 3000K

Douilles : 2xGX53 Ø max. : 7,5 cm | L : 3,5 cm

Coloris	Ref.	CHF
● anthracite	1002018	192.00

Coloris	Ref.	CHF
● anthracite	230365	124.00



LED GX53 | 6,1W | 120°
3000K | 490lm | CEE=G
6kWh / 1000h



Ref. : 1005271 | 13.50 CHF



1000334 767



ROX
WL, QPAR111

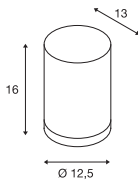

220-240V ~50/60 Hz
Matière : aluminium / verre



Douille : 1xGU10

Coloris	Ref.	CHF
● alu brossé	1000333	179.00



QPAR111 | 12,5W | 10°
3000K | 950lm | CEE=F
13kWh / 1000h



Ref. : 1005278 | 65.00 CHF

ROX UP/DOWN
WL, QPAR111

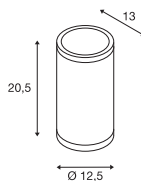

220-240V ~50/60 Hz
Matière : aluminium / verre



Douilles : 2xGU10

Coloris	Ref.	CHF
● alu brossé	1000334	229.00



QPAR111 | 12,5W | 10°
3000K | 950lm | CEE=F
13kWh / 1000h



Ref. : 1005278 | 65.00 CHF

DELWA
WL

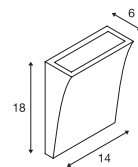

220-240V ~50/60Hz | 700mA
Puissance totale : 10W
Matière : aluminium / verre



Down

840lm | 3000K

Coloris	Ref.	CHF
● anthracite	1000342	239.00
○ blanc	1000340	239.00

SLOTS
WL

WALLYX
WL, QPAR51

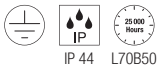
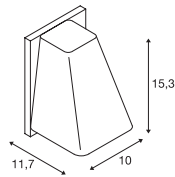
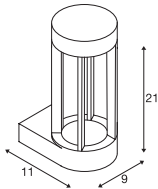

220-240V ~50/60 Hz
Puissance totale : 4,5W
Matière : aluminium / verre



220-240V ~50/60 Hz
Matière : aluminium / verre



Down 140lm | 3000K



Douille : 1xGU10 L max. : 7,6 cm

Coloris	Ref.	CHF
● anthracite	231805	202.00
● rouille	231807	202.00

Coloris	Ref.	CHF
● anthracite	227195	138.00



LED GU10 51mm | 6W | 38°
2700K | 450lm | CEE=F
6kWh / 1000h



Ref. : 1005077 | 10.60 CHF

227195

768

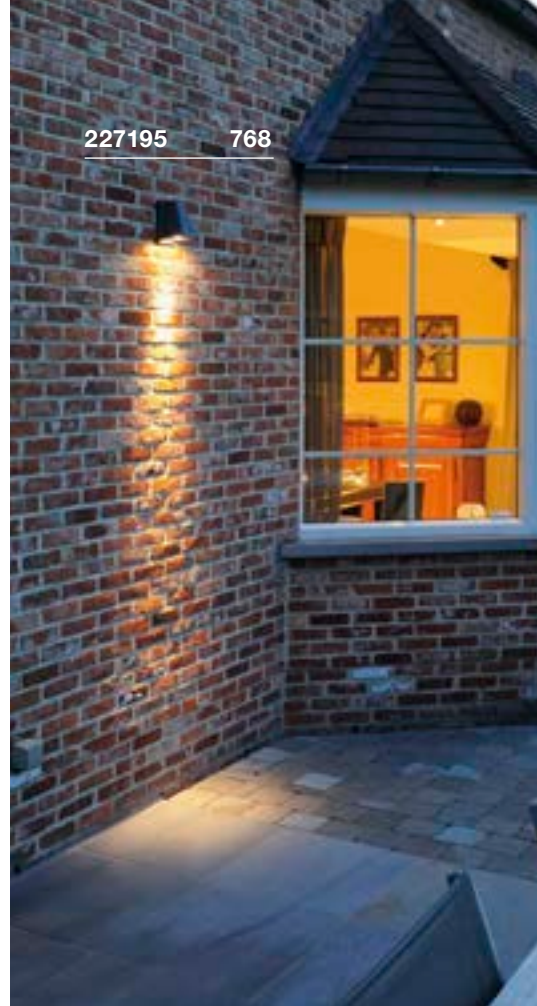



DOWNUNDER OUT
WL, rond

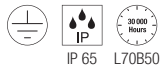
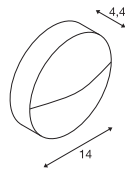

100-240V ~50/60Hz | 500mA
Puissance totale : 4,3W
Matière : aluminium



Down 150lm | 3000K | 160lm | 4000K

Coloris	Ref.	CHF
● anthracite	1002868	169.00

DOWNUNDER OUT
WL, carré

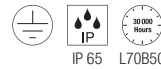
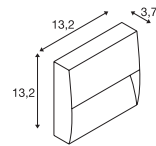

100-240V ~50/60Hz | 500mA
Puissance totale : 4,3W
Matière : aluminium



Down 150lm | 3000K | 160lm | 4000K

Coloris	Ref.	CHF
● anthracite	1002869	169.00

1002868 769

ABRIDOR SENSOR WL

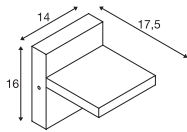

100-240V ~50/60Hz | 300mA
Puissance totale : 12W
Matière : aluminium



Down 950lm | 3000K | 980lm | 4000K

Coloris	Ref.	CHF
● anthracite	1002990	239.00

ABRIDOR WL

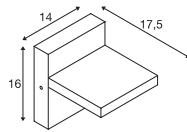

100-240V ~50/60Hz | 300mA
Puissance totale : 12W
Matière : aluminium



Down 950lm | 3000K | 980lm | 4000K

Coloris	Ref.	CHF
● anthracite	1002989	219.00

1002990 770





ORDI SENSOR
WL

ORDI
WL

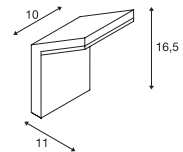
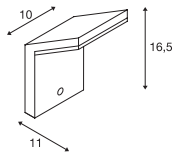

220-240V ~50/60Hz | 110mA
Puissance totale : 9W
Matière : aluminium

220-240V ~50/60Hz | 110mA
Puissance totale : 9W
Matière : aluminium



Down 740lm | 3000K

Down 740lm | 3000K

Coloris	Ref.	CHF
● anthracite	232915	179.00

Coloris	Ref.	CHF
● anthracite	232905	149.00

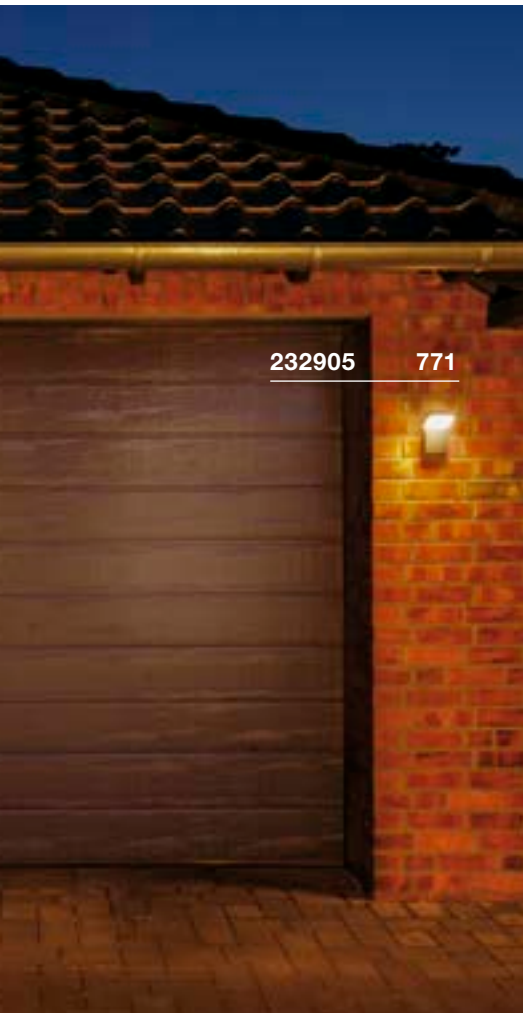

232905

771



232495 773



1002035 773



232485 773



BOX-L
WL, E27

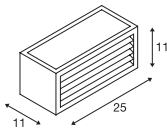

220-240V ~50/60 Hz
Matière : aluminium / acrylique



Douille : 1xE27 Ø max. : 6 cm L : 17,5 cm

Coloris	Ref.	CHF
● anthracite	232495	125.00
○ blanc	232491	125.00
● rouille	232497	125.00



LED E27 | 8W | 240°
3000K | 880lm | CEE=E
8kWh / 1000h



Ref. : 1005289 | 12.90 CHF

BOX-L
WL

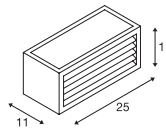

100-277V ~50/60Hz | 500mA
Puissance totale : 19W
Matière : aluminium / acrylique



Down 600lm | 3000K

Coloris	Ref.	CHF
● anthracite	1002035	160.00

BOX UP/DOWN
WL, QT-DE12

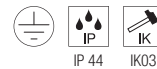
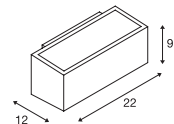

220-240V ~50/60 Hz
Matière : aluminium



Douille : 1xR7s 78 mm

Coloris	Ref.	CHF
● anthracite	232485	125.00



LED R7s | 9W | 330°
3000K | 1050lm | CEE=E
9kWh / 1000h



Ref. : 1005287 | 27.70 CHF



232101 775

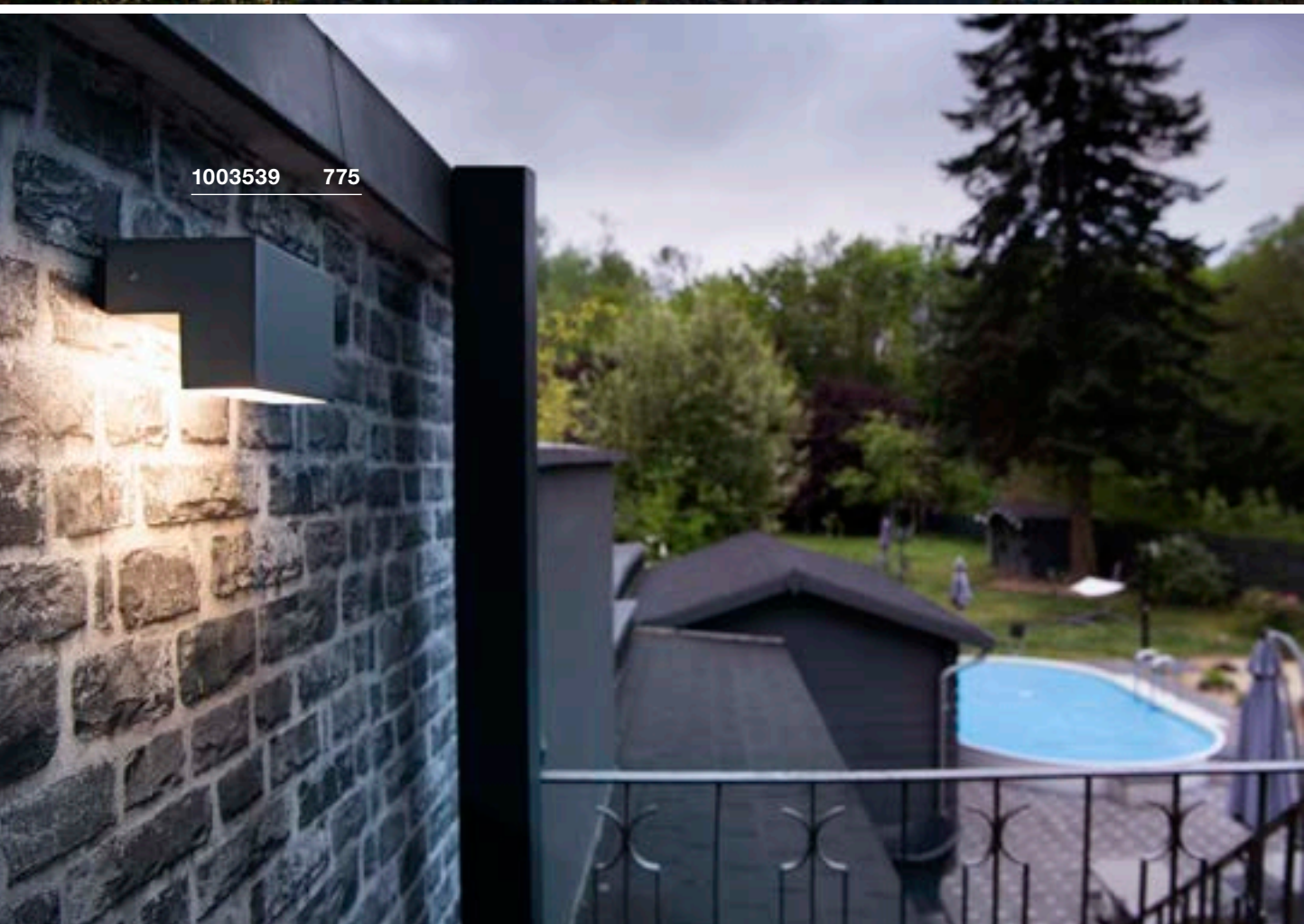

1003539 775



LOGS
WL

OUT-BEAM UP /
FLOOD DOWN
WL

L-LINE OUT
WL

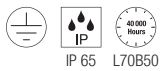
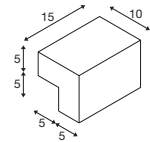
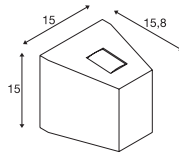
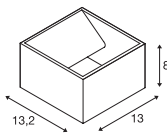

220-240V ~50/60Hz | 500mA
Puissance totale : 9,5W
Matière : aluminium



220-240V ~50/60Hz | 500mA
Puissance totale : 18W
Matière : aluminium / verre

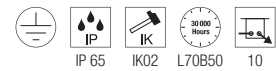

220-240V ~50/60Hz | 350mA
Puissance totale : 7W
Matière : aluminium / polycarbonate (PC)



Down 520lm | 3000K
800lm



Up 50lm | 3000K
Down 690lm | 3000K



Down 500lm | 3000K | 570lm | 4000K

Coloris	Ref.	CHF
● anthracite		
520lm	232105	279.00
○ blanc		
800lm	232101	279.00

Coloris	Ref.	CHF
● anthracite	229665	329.00
● gris	229664	329.00

Coloris	Ref.	CHF
● anthracite	1003539	172.00

232045 777





PHOTONIA
WL, E27

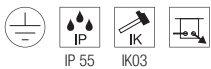
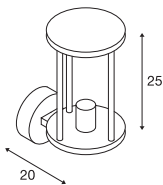

220-240V ~50/60 Hz
Matière : aluminium / verre



Douille : 1xE27 Ø max. : 9 cm L : 15 cm

Coloris	Ref.	CHF
● anthracite	232045	259.00

LED E27 | 7,5W | 320°
2500K | 700lm | CEE=F
8kWh / 1000h

Ref. : 1005265 | 33.00 CHF

⊕

Article	Ref.	CHF
Entretoises		
● anthracite	1002853	10.60

MOLAT
WL, E27

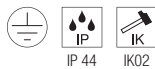
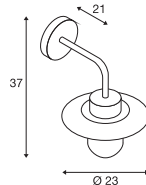

220-240V ~50/60 Hz
Matière : aluminium / verre



Douille : 1xE27 Ø max. : 6,5 cm L : 14,5 cm

Coloris	Ref.	CHF
● anthracite	1000820	134.00

A60 | 7,5W | 320°
2700K | 800lm | CEE=F
8kWh / 1000h

Ref. : 1005303 | 12.90 CHF

GLOO PURE
WL, E27

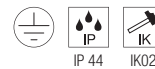
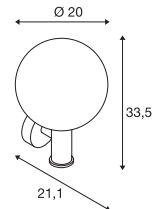

220-240V ~50/60 Hz
Matière : aluminium / verre



Douille : 1xE27 Ø max. : 4,8 cm L : 18 cm

Coloris	Ref.	CHF
● anthracite	1002002	117.00

LED E27 | 8W | 240°
4000K | 920lm | CEE=E
8kWh / 1000h

Ref. : 1005290 | 12.90 CHF



1000336 779

F-POL
WL, E27

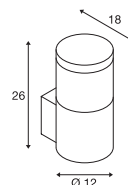

230355 779

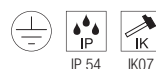

220-240V ~50/60 Hz
Matière : aluminium / polycarbonate (PC)



Douille : 1xE27 Ø max. : 5,1 cm L : 14 cm

Coloris	Ref.	CHF
● anthracite	231585	169.00



LED E27 | 8W | 240°
4000K | 920lm | CEE=E
8kWh / 1000h



Ref. : 1005290 | 12.90 CHF



CARRÉ WL, E27

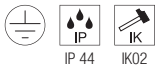
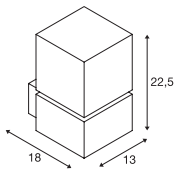

220-240V ~50/60 Hz
Matière : acier inoxydable 304



Douille : 1xE27 Ø max. : 7 cm L : 13 cm

Coloris	Ref.	CHF
● inox	1000336	259.00



A60 | 7,5W | 320°
2700K | 800lm | CEE=F
8kWh / 1000h



Ref. : 1005303 | 12.90 CHF

KERAS ELT WL, E27

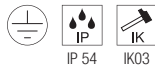
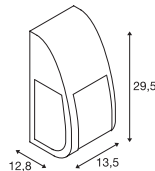

220-240V ~50/60 Hz
Matière : aluminium / polycarbonate (PC)



Douille : 1xE27 Ø max. : 7 cm L : 17,5 cm

Coloris	Ref.	CHF
● anthracite	227176	202.00



A60 | 7,5W | 320°
2700K | 800lm | CEE=F
8kWh / 1000h



Ref. : 1005303 | 12.90 CHF

SITRA WL, TCR-TSE

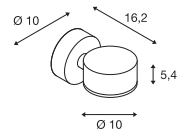

220-240V ~50/60 Hz
Matière : aluminium / verre



Douille : 1xGX53 Ø max. : 7,5 cm L : 3,5 cm

Coloris	Ref.	CHF
● anthracite	230355	117.00



LED GX53 | 6,1W | 120°
3000K | 490lm | CEE=G
6kWh / 1000h



Ref. : 1005271 | 13.50 CHF

RASCALI
WL

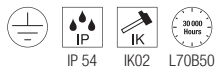
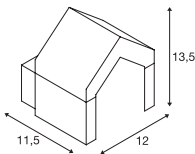

220-240V ~50/60 Hz
Puissance totale : 8W
Matière : aluminium



Down 330lm | 3000K

Coloris	Ref.	CHF
● anthracite	1000797	160.00

IPERI
WL

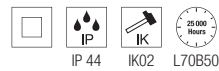
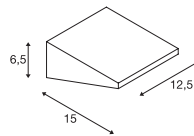

220-240V ~50/60 Hz
Puissance totale : 4,5W
Matière : aluminium

- Protection IP44 uniquement en cas de montage avec le faisceau vers le bas.



Down 400lm | 4000K

Coloris	Ref.	CHF
● noir	231315	149.00

1000797 780





231315 781

QUADRASYL
WL, TCR-TSE

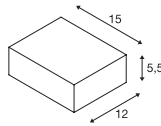

220-240V ~50/60 Hz
Matière : aluminium / verre



Douille : 1xGX53 Ø max. : 7,5 cm L : 2,7 cm

Coloris	Ref.	CHF
● anthracite	232285	85.00



LED GX53 | 6,1W | 120°
3000K | 490lm | CEE=G
6kWh / 1000h



Ref. : 1005271 | 13.50 CHF

CARRÉ TURN
WL, G9

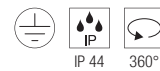
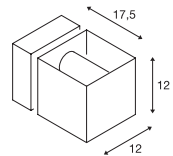

220-240V ~50/60 Hz
Matière : aluminium / verre



Douille : 1xG9 Ø max. : 3,5 cm L : 8 cm

Coloris	Ref.	CHF
● gris	1000335	232.00



LED G9 | 3,6W | 300°
3000K | 400lm | CEE=E
4kWh / 1000h



Ref. : 1005286 | 12.90 CHF



1000335 781

1002905 783



233134 783





TODAY PRO
Display

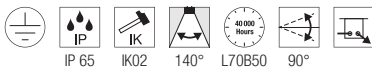
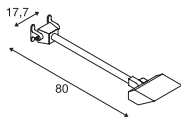

220-240V ~50/60Hz | 640mA
Puissance totale : 29W
Matière : aluminium



Down 2800lm | 4000K

Coloris	Ref.	CHF
● noir	1000880	259.00
○ blanc	1000881	259.00

ESKINA D
Display, PHASE

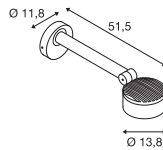

220-240V ~50/60Hz | 350mA
Puissance totale : 14,5W
Matière : aluminium

- Interrupteur CCT sur la tête de lampe



Down 1000lm | 3000K | 1000lm | 4000K

Coloris	Ref.	CHF
● anthracite	1002905	309.00

MYRA DISPLAY
WL, courbe, QPAR51

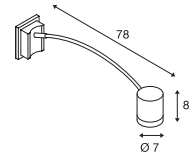

220-240V ~50/60 Hz
Matière : aluminium



Douille : 1xGU10 Ø max. : 5,1 cm | L : 5,7 cm

Coloris	Ref.	CHF
● anthracite	233135	209.00
● gris	233134	209.00



LED GU10 51mm | 6W | 38°
2700K | 450lm | CEE=F
6kWh / 1000h



Ref. : 1005077 | 10.60 CHF



Article	Ref.	CHF
Cadre pour montage sur crépis		
● anthracite	233215	25.55
● gris	233214	27.70

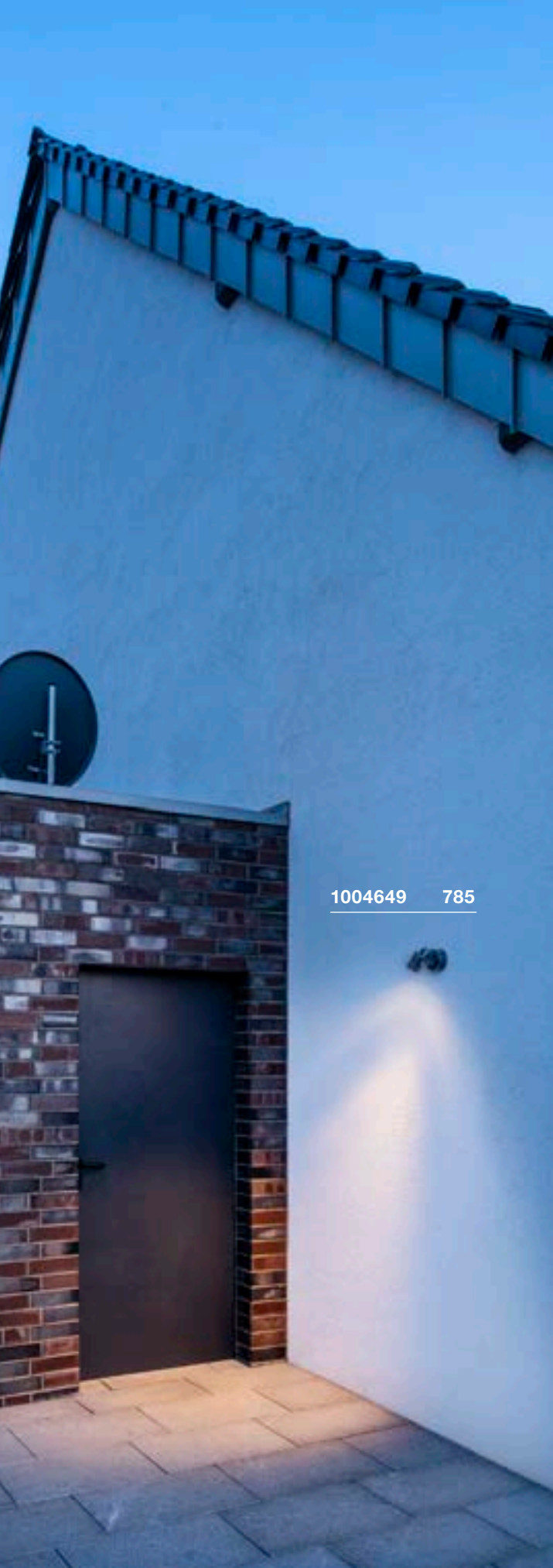

1004649 785

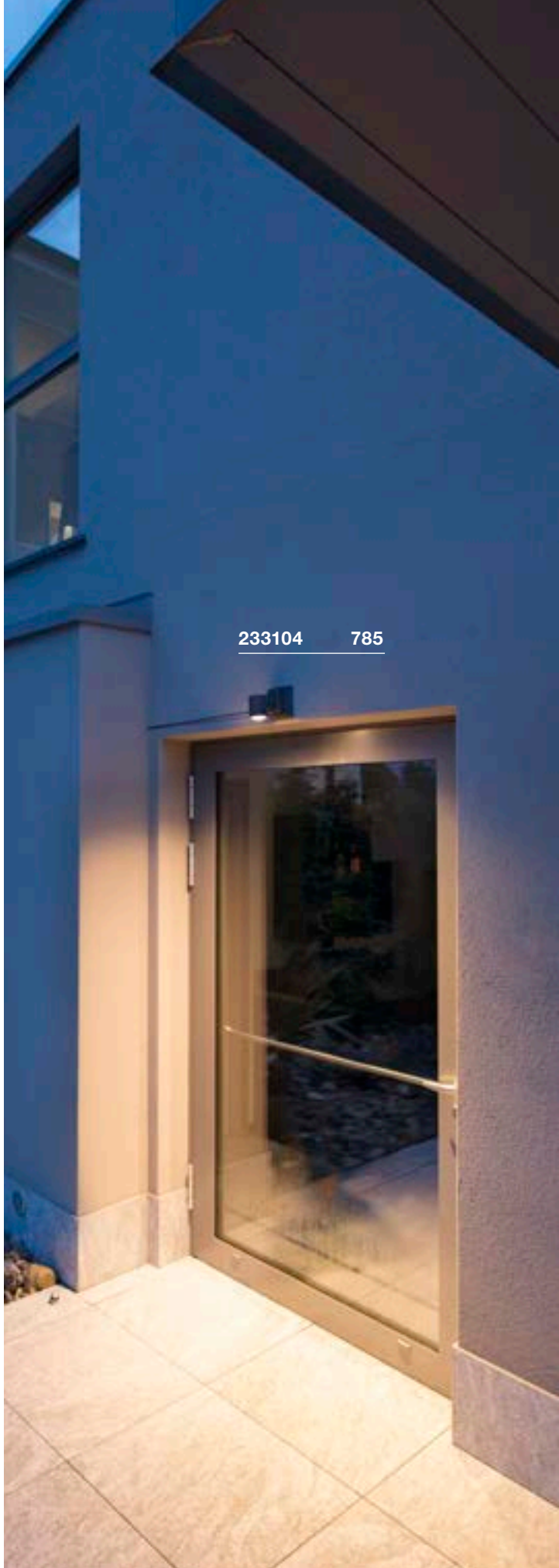

233104 785



LED SPOT
SP

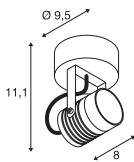

100-240V ~50/60Hz | 240mA
Puissance totale : 6W
Matière : aluminium / verre



Down 400lm | 3000K

Coloris	Ref.	CHF
● anthracite	1004649	85.00
● rouille	1004957	85.00

NAUTILUS
WL QPAR51

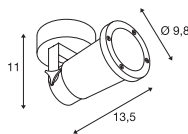

220-240V ~50/60 Hz
Matière : aluminium



Douille : 1xGU10 Ø max. : 5,1 cm L : 8,3 cm

Coloris	Ref.	CHF
● noir	1002867	81.00



LED GU10 51mm | 6W | 38°
2700K | 450lm | CEE=F
6kWh / 1000h



Ref. : 1005077 | 10.60 CHF



Article	Ref.	CHF
NAUTILUS Plaque de montage		
● noir	1002884	7.50

MYRA
CW, simple, QPAR51

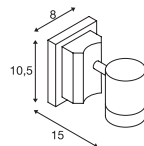

220-240V ~50/60 Hz
Matière : aluminium / verre



Douille : 1xGU10 Ø max. : 5,1 cm L : 5,7 cm

Coloris	Ref.	CHF
● anthracite	233105	128.00
● gris	233104	128.00



LED GU10 51mm | 6W | 38°
2700K | 450lm | CEE=F
6kWh / 1000h



Ref. : 1005077 | 10.60 CHF



Article	Ref.	CHF
Cadre pour montage sur crépis		
● anthracite	233215	25.55
● gris	233214	27.70

1003427 793





SCKET
PHOTONI | 789



LED
S-CUBE | 791



LED
ESKINA FRAME | 791



LED
ENOLA
OCULUS | 792



LED
ENOLA
ROUND S | 793



LED
ENOLA
ROUND M | 793



LED
ENOLA
ROUND L | 793



LED
ENOLA
SQUARE S | 795



LED
ENOLA
SQUARE M | 795



LED
ENOLA S
QUARE L | 795



LED
BIG THEO | 797



SCKET
BIG THEO | 797



LED
OVALISK | 797



SCKET
PHOTONIA | 799



SCKET
MOLAT | 799



SCKET
SITRA | 801



SCKET
ROX | 801



SCKET
ROX | 801

1007586 789

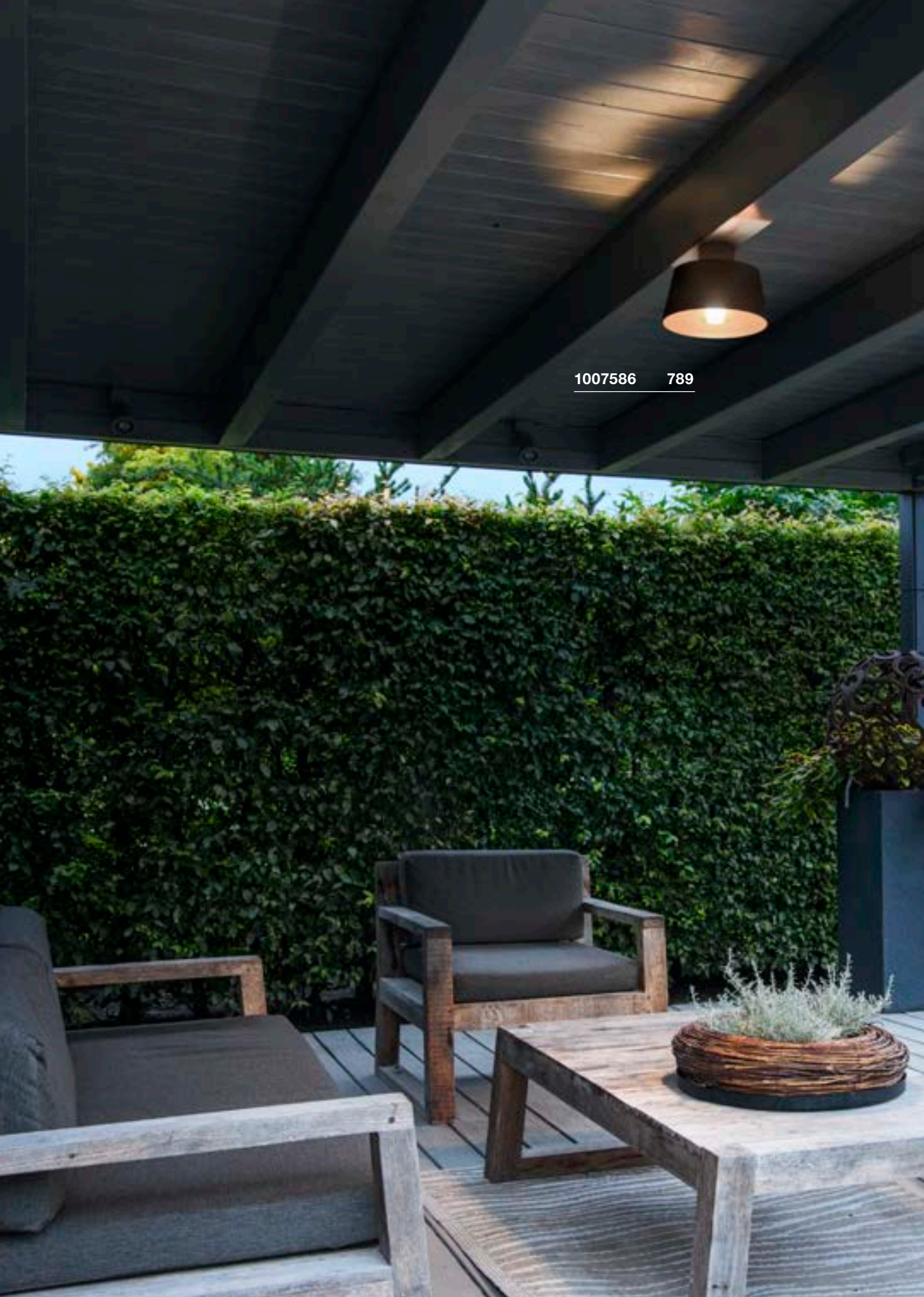



PHOTONI CL, E27

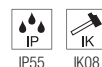
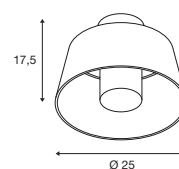

220-240V ~50/60Hz
Matière : aluminium

- Résiste à l'air marin

SOCKET
INSIDE 13
W

Douille : 1xE27 Ø max. : 6 cm L : 11,6 cm

Coloris	Ref.	CHF
● noir	1007586	● 113.90
● rouille	1007582	● 113.90



LED E27 | 8W | 240°
3000K | 880lm | CEE=E
8kWh / 1000h



Ref. : 1005289 | 12.90 CHF

1007461 791





S-CUBE CL

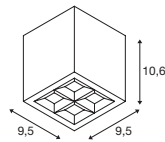

220-240V ~50/60Hz | 350mA
Puissance totale : 15W
Matière : aluminium



Down 1000lm | 2700K | 1200lm | 3000K

Coloris	Ref.	CHF
● anthracite	1007461	● 154.10

ESKINA FRAME CL, simple

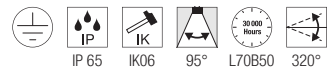
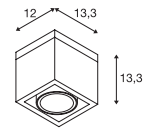

220-240V ~50/60Hz | 350mA
Puissance totale : 15W
Matière : aluminium / verre



Down 1100lm | 3000K | 1200lm | 4000K

Coloris	Ref.	CHF
● anthracite	1006316	219.00

ENOLA OCULUS CL

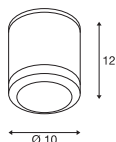

220-240V ~50/60Hz | 500mA
 Puissance totale : 11W
 Matière : aluminium / verre



Down 1000lm | 3000K | 1100lm | 4000K

Coloris	Ref.	CHF
● anthracite	1006327	289.00



Article	Ref.	CHF
Entretoises		
● anthracite	1003479	11.25



1006327 792



ENOLA ROUND S CL

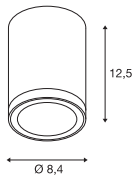

220-240V ~50/60Hz | 500mA
Puissance totale : 9W
Matière : aluminium / verre



Down 540lm | 3000K | 610lm | 4000K

Coloris	Ref.	CHF
● anthracite	1003426	219.00



Article	Ref.	CHF
Entretoises		
● anthracite	1003479	11.25
Réflecteur 60°		
● chrome	1005262	20.20

ENOLA ROUND M CL

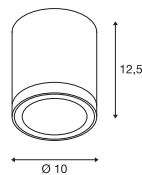

220-240V ~50/60Hz | 500mA
Puissance totale : 11W
Matière : aluminium / verre



Down 840lm | 3000K | 960lm | 4000K

Coloris	Ref.	CHF
● anthracite	1003427	279.00



Article	Ref.	CHF
Entretoises		
● anthracite	1003479	11.25
Lentille 19°		
● noir	1005205	52.00
Lentille asymétrique		
● noir / chrome	1005206	52.00
Réflecteur 60°		
● chrome	1005262	20.20

ENOLA ROUND L CL

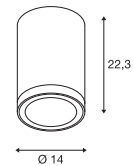

220-240V ~50/60Hz | 900mA
Puissance totale : 36W
Matière : aluminium / verre



Down 3200lm | 3000K | 3500lm | 4000K

Coloris	Ref.	CHF
● anthracite	1003442	359.00



Article	Ref.	CHF
Entretoises		
● anthracite	1003479	11.25
Réflecteur 60°		
● chrome	1005263	27.70

1003421 795

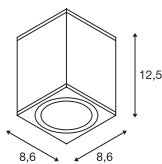

ENOLA CARRÉ S
CL

220-240V ~50/60Hz | 500mA
Puissance totale : 9W
Matière : aluminium / verre



Down 540lm | 3000K | 610lm | 4000K

Coloris	Ref.	CHF
● anthracite	1003420	219.00

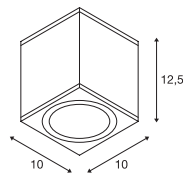

Article	Ref.	CHF
Entretoises		
● anthracite	1003479	11.25
Réflecteur 60°		
● chrome	1005262	20.20

ENOLA CARRÉ M
CL

220-240V ~50/60Hz | 500mA
Puissance totale : 11W
Matière : aluminium / verre



Down 840lm | 3000K | 960lm | 4000K

Coloris	Ref.	CHF
● anthracite	1003421	279.00

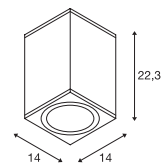

Article	Ref.	CHF
Entretoises		
● anthracite	1003479	11.25
Lentille 19°		
● noir	1005205	52.00
Lentille asymétrique		
● noir / chrome	1005206	52.00
Réflecteur 60°		
● chrome	1005207	29.90

ENOLA CARRÉ L
CL

220-240V ~50/60Hz | 900mA
Puissance totale : 36W
Matière : aluminium / verre



Down 3200lm | 3000K | 3500lm | 4000K

Coloris	Ref.	CHF
● anthracite	1003439	359.00



Article	Ref.	CHF
Entretoises		
● anthracite	1003479	11.25
Réflecteur 60°		
● chrome	1005263	27.70



234535 797



1004677 797



BIG THEO CL

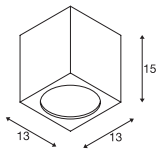

100-277V ~50/60Hz | 500mA
Puissance totale : 21W
Matière : aluminium / verre



Down 2000lm | 3000K

Coloris	Ref.	CHF
● anthracite	234535	239.00

BIG THEO CL, QPAR111

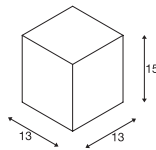

220-240V ~50/60Hz
Matière : aluminium / verre



Douille : 1xGU10

Coloris	Ref.	CHF
● anthracite	229555	160.00
○ blanc	229551	160.00
● gris	229554	160.00



QPAR111 | 12,5W | 10°
3000K | 950lm | CEE=F
13kWh / 1000h

Ref. : 1005278 | 65.00 CHF



OVALISK CL

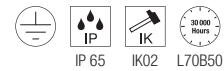
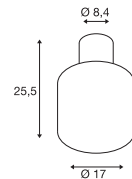

220-240V ~50/60Hz | 350mA
Puissance totale : 7,9W
Matière : aluminium / verre



Down 540lm | 3000K | 570lm | 4000K

Coloris	Ref.	CHF
● anthracite	1004677	309.00

232055 799

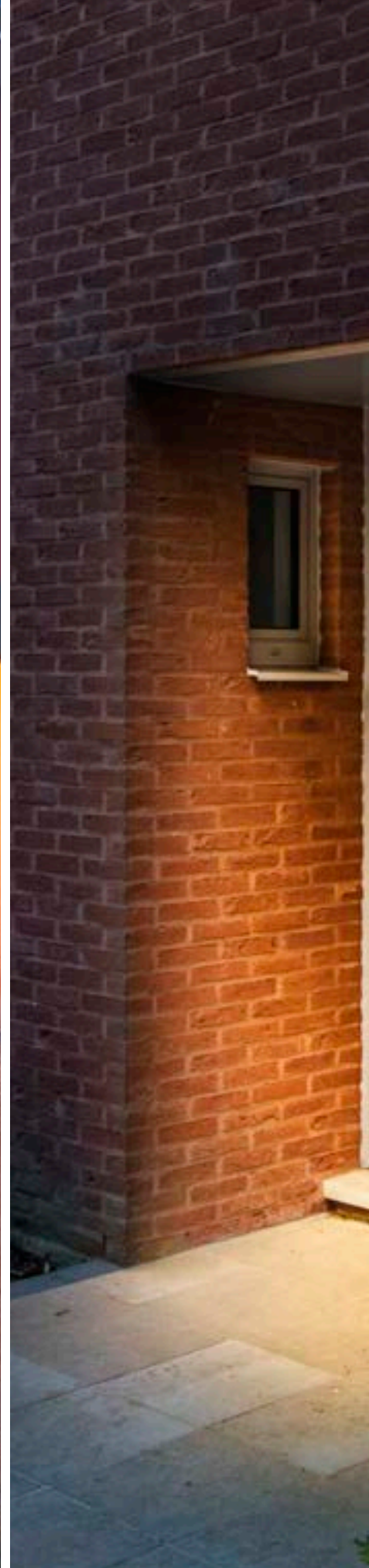



PHOTONIA CL, E27

MOLAT CL, E27

1000823 799

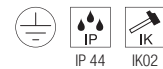
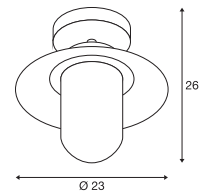
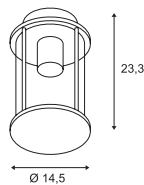

220-240V ~50/60Hz
Matière : aluminium / verre

220-240V ~50/60Hz
Matière : aluminium / verre

SOCKET **INSIDE** <60
W

SOCKET **INSIDE** <60
W

Douille : 1xE27 Ø max. : 9 cm L : 15 cm

Douille : 1xE27 Ø max. : 6,5 cm L : 14,5 cm

Coloris	Ref.	CHF
● anthracite	232055	239.00

Coloris	Ref.	CHF
● anthracite	1000823	152.00



LED E27 | 7,5W | 320°
2500K | 700lm | CEE=F
8kWh / 1000h



Ref. : 1005265 | 33.00 CHF



LED E27 | 7,5W | 320°
2500K | 700lm | CEE=F
8kWh / 1000h



Ref. : 1005265 | 33.00 CHF



Article	Ref.	CHF
Entretoises		
● anthracite	1002853	10.60

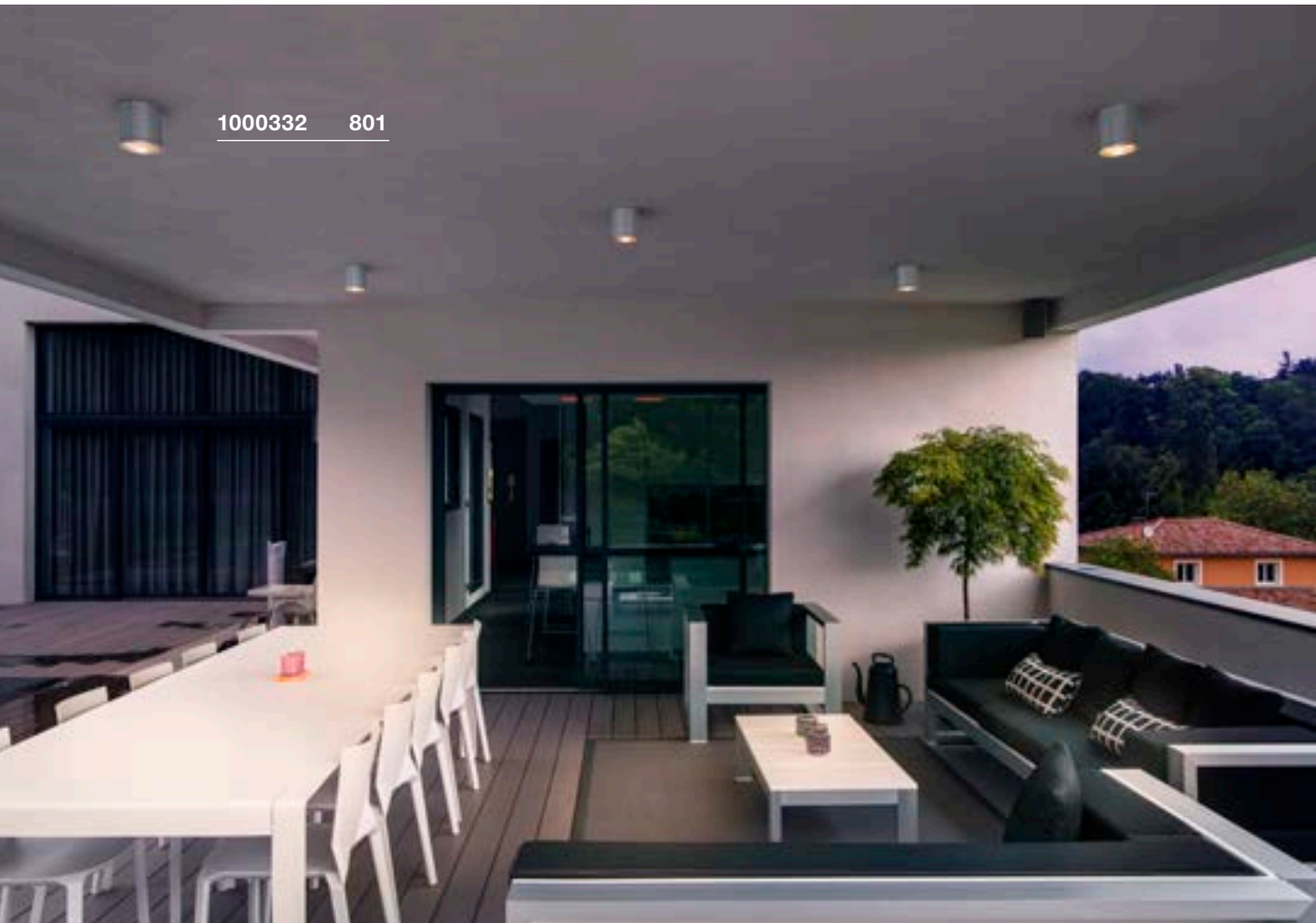



SITRA
CL, TCR-TSE

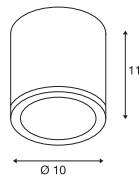

220-240V ~50/60Hz
Matière : aluminium / verre



Douille : 1xGX53 Ø max. : 7,5 cm L : 3,5 cm

Coloris	Ref.	CHF
● anthracite	231545	117.00
○ blanc	231541	117.00



LED GX53 | 6,1W | 120°
3000K | 490lm | CEE=G
6kWh / 1000h



Ref. : 1005271 | 13.50 CHF

ROX
CL, QPAR111

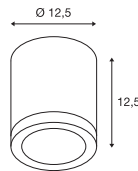

220-240V ~50/60Hz
Matière : aluminium / verre



Douille : 1xGU10

Coloris	Ref.	CHF
● alu brossé	1000332	156.00



QPAR111 | 12,5W | 10°
3000K | 950lm | CEE=F
13kWh / 1000h



Ref. : 1005278 | 65.00 CHF

ROX
CL, GX53

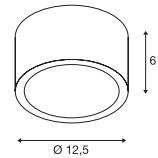

220-240V ~50/60Hz
Matière : aluminium / verre



Douille : 1xGX53 Ø max. : 7,5 cm L : 3,5 cm

Coloris	Ref.	CHF
● alu brossé/ transparent	1000339	202.00



LED GX53 | 6,1W | 120°
3000K | 490lm | CEE=G
6kWh / 1000h



Ref. : 1005271 | 13.50 CHF

1005202 811





LED
R-CUBE | 805



LED
S-CUBE | 805



SCKET
S-TUBE | 805



LED
ESKINA SPOT
SENSOR | 807



LED
ESKINA SPOT | 807



SCKET
SITRA 360 | 808



SCKET
THEO BRACKET | 808



LED
HELIA | 809



LED
HELIA | 809



SCKET
MYRA | 811



LED
OUT-BEAM
FRAME | 811



LED
QUADRULO | 811



LED
AINOS | 812-813



LED
AINOS | 813



LED
AINOS | 813



LED
RUBA | 814



SCKET
BULAN | 815



SCKET
BULAN GRID | 815



LED
TERANG 200 | 817



LED
IMPERVA | 817



1007511 805

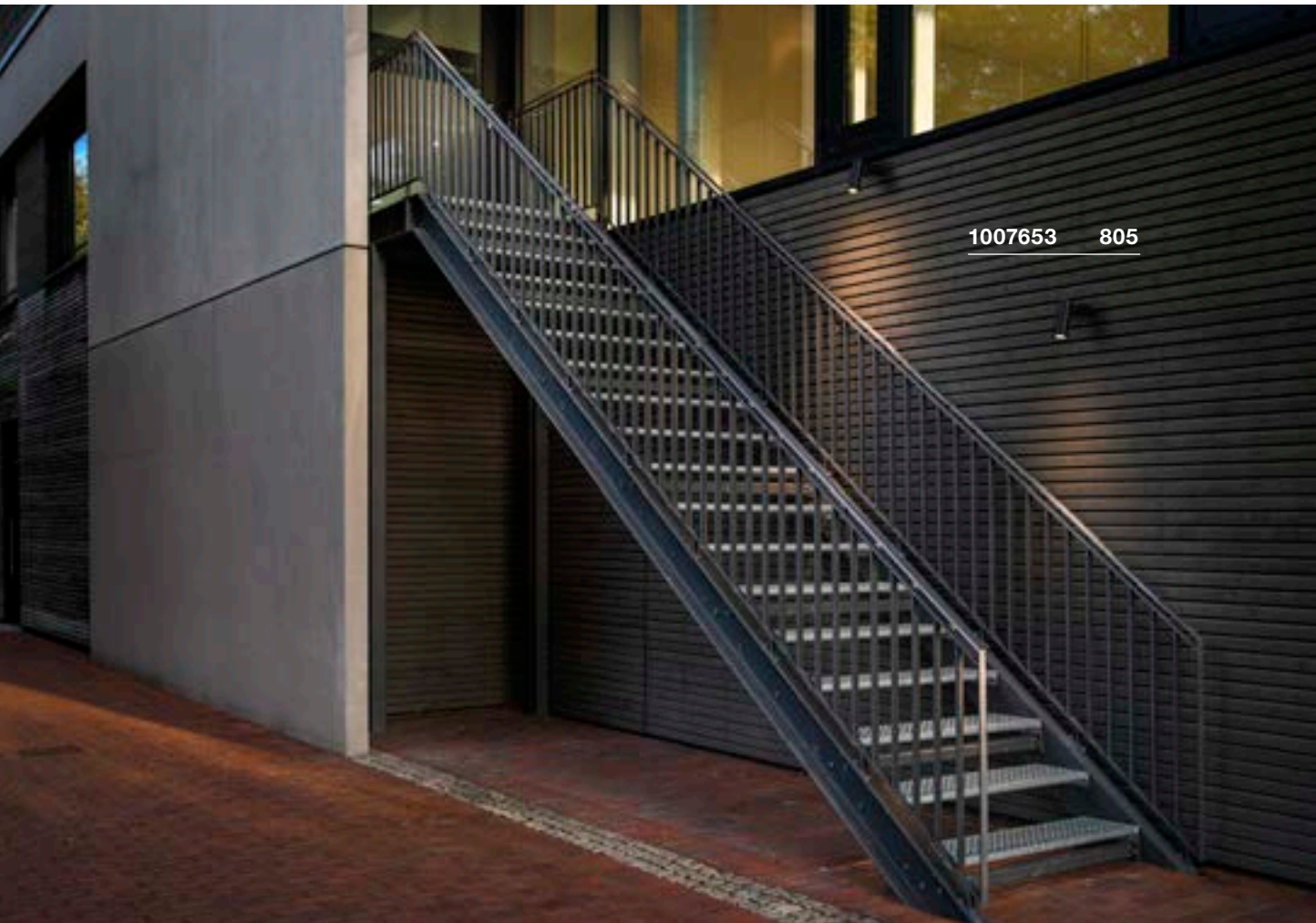

1007653 805



R-CUBE
CW

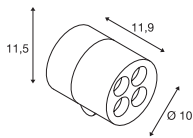

Antracite

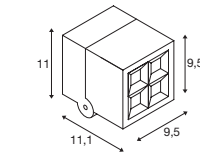

S-TUBE
CW

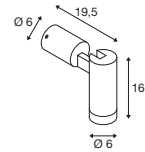

220-240V ~50/60Hz | 350mA
Puissance totale : 15W
Matière : aluminium



220-240V ~50/60Hz | 350mA
Puissance totale : 15W
Matière : aluminium

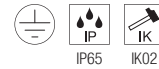

220-240V ~50/60Hz
Matière : aluminium



Down 800lm | 2700K | 800lm | 3000K



Down 1000lm | 2700K | 1200lm | 3000K



Douille : 1xGU10 Ø max. : 5 cm | L : 5,5 cm

Coloris	Ref.	CHF
● anthracite	1007511	● 177.10

Coloris	Ref.	CHF
● anthracite	1007458	● 177.10

Coloris	Ref.	CHF
● noir	1007653	● 113.90



LED GU10 51 mm | 6W | 38°
2700K | 450lm | CEE=F
6kWh / 1000h



Ref. : 1005077 | 10.60 CHF

1002904 807

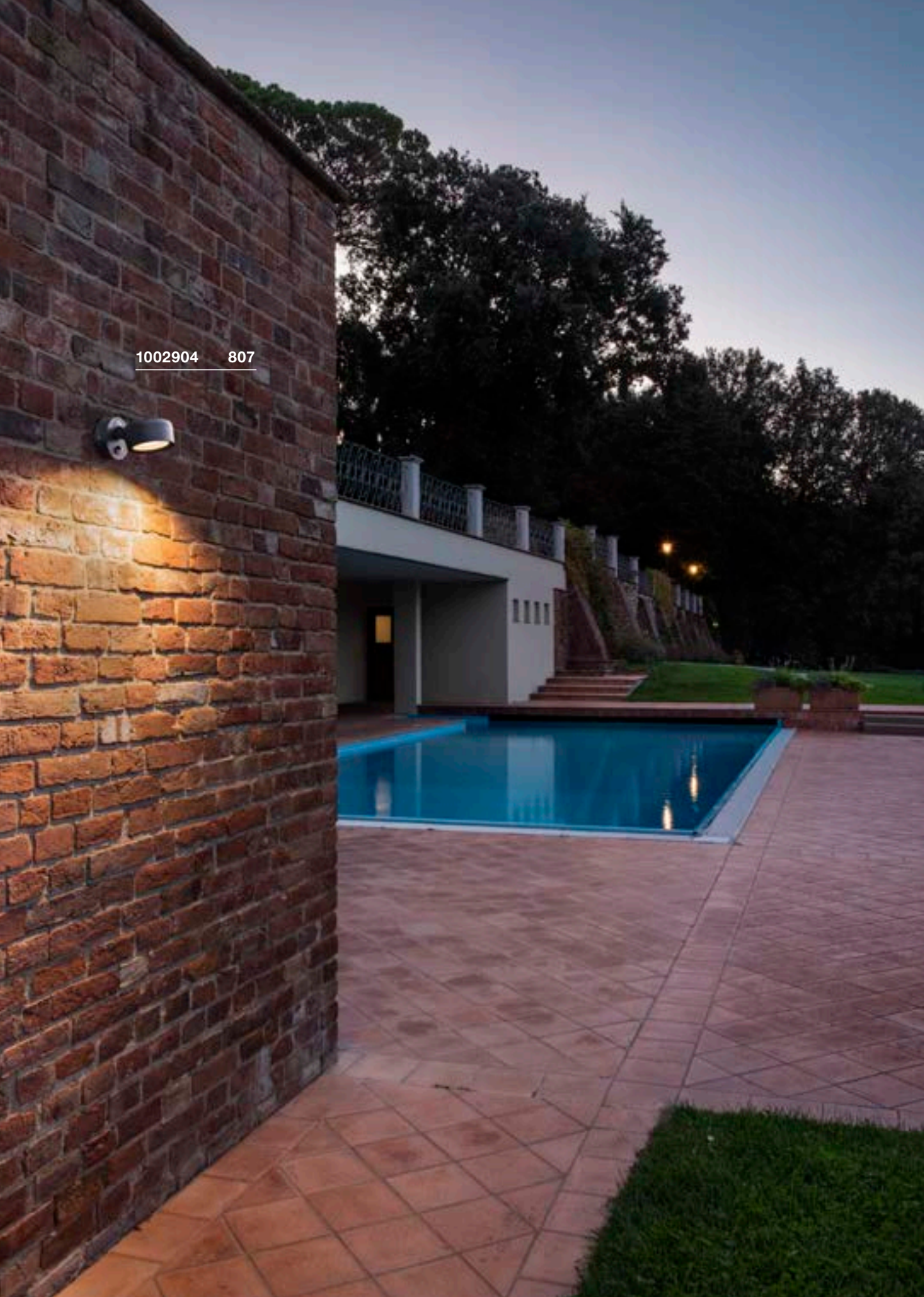



ESKINA SPOT SENSOR CW, PHASE

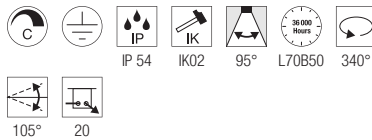
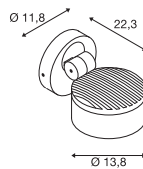

220-240V ~50/60Hz | 350mA
Puissance totale : 15W
Matière : aluminium

- Détecteur de mouvement intégré à la patère.



Down 1000lm | 3000K | 1000lm | 4000K

Coloris	Ref.	CHF
● anthracite	1002904	309.00

ESKINA SPOT CW, PHASE

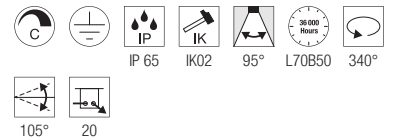
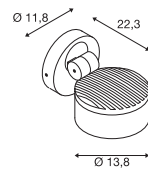

220-240V ~50/60Hz | 350mA
Puissance totale : 14,5W
Matière : aluminium



Down 1000lm | 3000K | 1000lm | 4000K

Coloris	Ref.	CHF
● anthracite	1002903	279.00

SITRA 360
CW, TCR-TSE

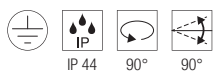
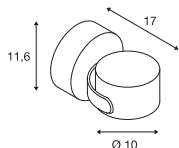

220-240V ~50/60Hz
Matière : aluminium / verre



Douille : 1xGX53 Ø max. : 7,5 cm L : 3,5 cm

Coloris	Ref.	CHF
● anthracite	231515	99.00



LED GX53 | 6,1W | 120°
3000K | 490lm | CEE=G
6kWh / 1000h



Ref. : 1005271 | 13.50 CHF

THEO BRACKET
CW

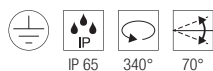
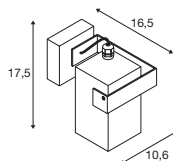

220-240V ~50/60Hz
Matière : aluminium / verre



Douille : 1xGU10 Ø max. : 5,1 cm L : 5,7 cm

Coloris	Ref.	CHF
● anthracite	1004653	94.00



LED GU10 51 mm | 6W | 38°
2700K | 450lm | CEE=F
6kWh / 1000h



Ref. : 1005077 | 10.60 CHF



233245 809



1004653 808

HELIA
CW, simple, PHASE

HELIA
CW, double, PHASE

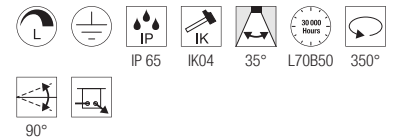
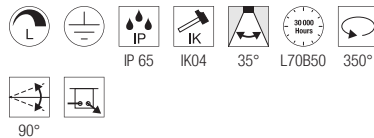
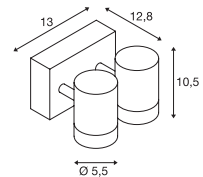
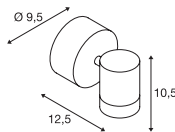

220-240V ~50/60Hz | 500mA
Puissance totale : 6,5W
Matière : aluminium / verre

220-240V ~50/60Hz | 500mA
Puissance totale : 13W
Matière : aluminium / verre



Down 440lm | 3000K

Down 880lm | 3000K

Coloris	Ref.	CHF
● anthracite	233245	219.00

Coloris	Ref.	CHF
● anthracite	233255	399.00



Article	Ref.	CHF
Entretoises		
● anthracite	1002853	10.60

Article	Ref.	CHF
Entretoises		
● anthracite	1002853	10.60

1003519 811



1005202 811

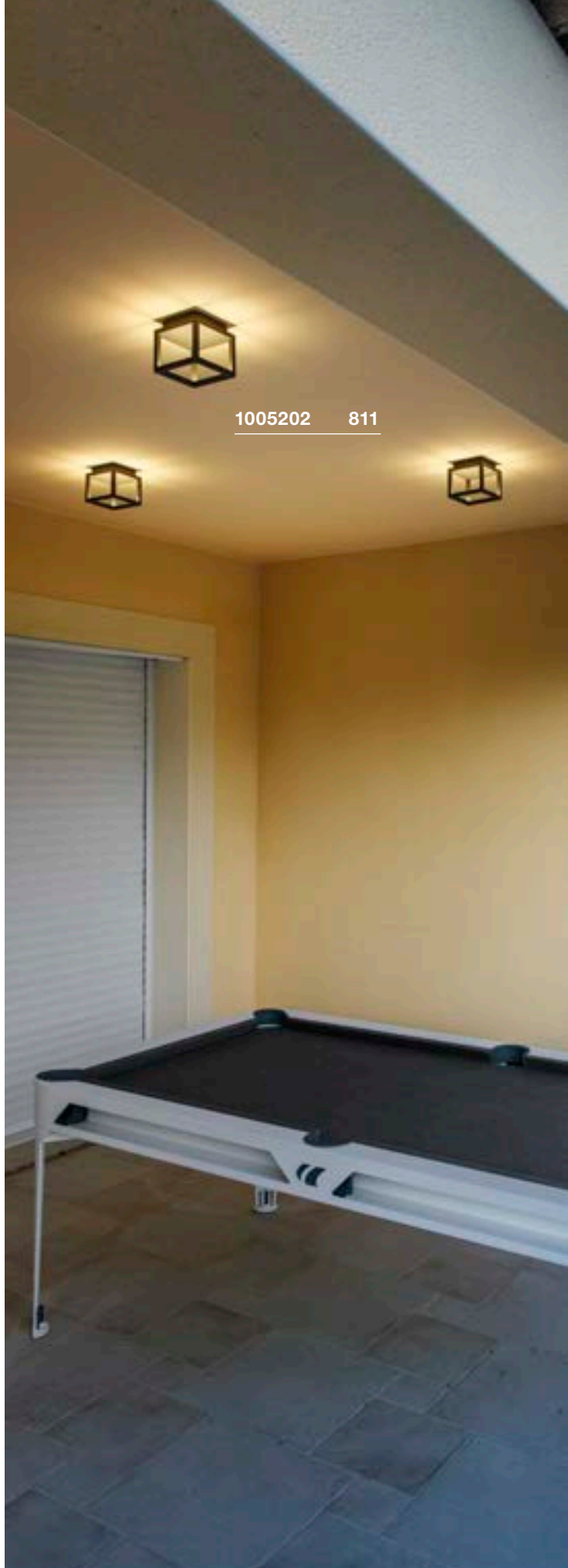



MYRA
WL, double, QPAR51

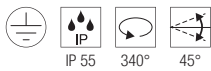
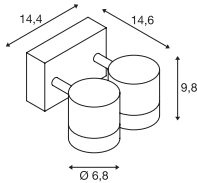

220-240V ~50/60Hz
Matière : aluminium / verre



Douilles : 2xGU10 | Ø max. : 5,1 cm | L : 5,7 cm

Coloris	Ref.	CHF
● anthracite	233095	219.00
● gris	233094	219.00



LED GU10 51 mm | 6W | 38°
2700K | 450lm | CEE=F
6kWh / 1000h



Ref. : 1005077 | 10.60 CHF



Article	Ref.	CHF
Entretoises		
● anthracite	1002853	10.60

OUT-BEAM FRAME
SP

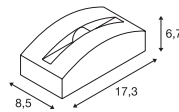

100-240V ~50/60Hz | 700mA
Puissance totale : 3,5W
Matière : aluminium / acrylique



Down | 60lm | 3000K

Coloris	Ref.	CHF
● anthracite	1003518	145.00
○ blanc	1003519	145.00

QUADRULO
CL

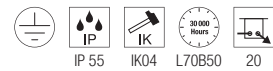
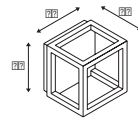

100-277V ~50/60Hz | 480mA
Puissance totale : 7,5W
Matière : aluminium / acrylique



Down | 230lm | 3000K

Coloris	Ref.	CHF
● anthracite	1005202	209.00



229971 813

AINOS CW

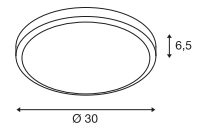

1003452 813

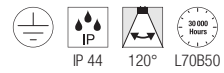

220-240V ~50/60Hz | 500mA
Puissance totale : 21W
Matière : aluminium / polycarbonate (PC)



Down

1430lm | 3000K

Coloris	Ref.	CHF
● anthracite	229965	202.00
○ blanc	229961	202.00



AINOS CW SENSOR

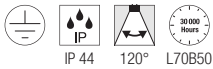
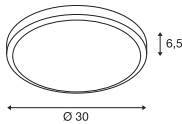

220-240V ~50/60Hz | 500mA
Puissance totale : 22W
Matière : aluminium / polycarbonate (PC)

- Capteur intégré au boîtier.



Down 1430lm | 3000K

Coloris	Ref.	CHF
● anthracite	229975	239.00
○ blanc	229971	239.00

AINOS CW, carré

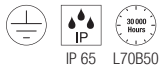
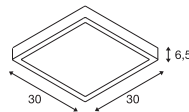

220-240V ~50/60Hz | 500mA
Puissance totale : 17W
Matière : aluminium / polycarbonate (PC)

- Capteur intégré au boîtier.



Down 1300lm | 3000K | 1300lm | 4000K

Coloris	Ref.	CHF
● anthracite	1003450	193.00
○ blanc	1003449	193.00

AINOS CW SENSOR, carré

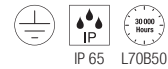
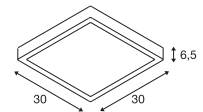

220-240V ~50/60Hz | 500mA
Puissance totale : 18W
Matière : aluminium / polycarbonate (PC)

- Capteur intégré au boîtier.



Down 1300lm | 3000K | 1300lm | 4000K

Coloris	Ref.	CHF
● anthracite	1003452	245.00
○ blanc	1003451	245.00

RUBA CW

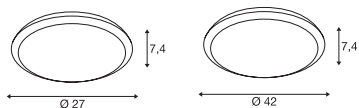

220-240V ~50/60Hz | 600mA
 Puissance totale : 22W
 Matière : polycarbonate (PC)



Down	960lm 2000lm	3000K	1100lm 2300lm	4000K
------	-----------------	-------	------------------	-------

Coloris	Ref.	CHF
○ blanc Ø: 27cm 960 / 1100lm 12W	1005089	138.00
○ blanc Ø: 42cm 2000 / 2300lm 22W	1005090	259.00

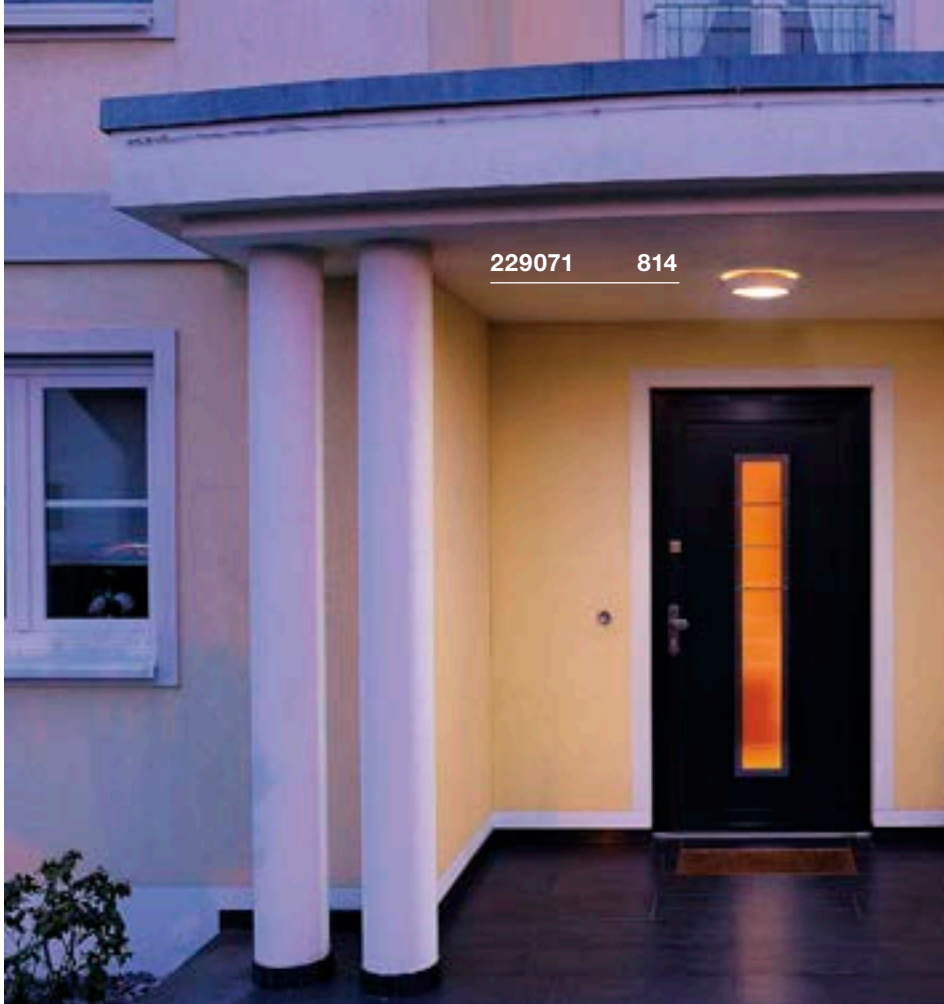

229071 814



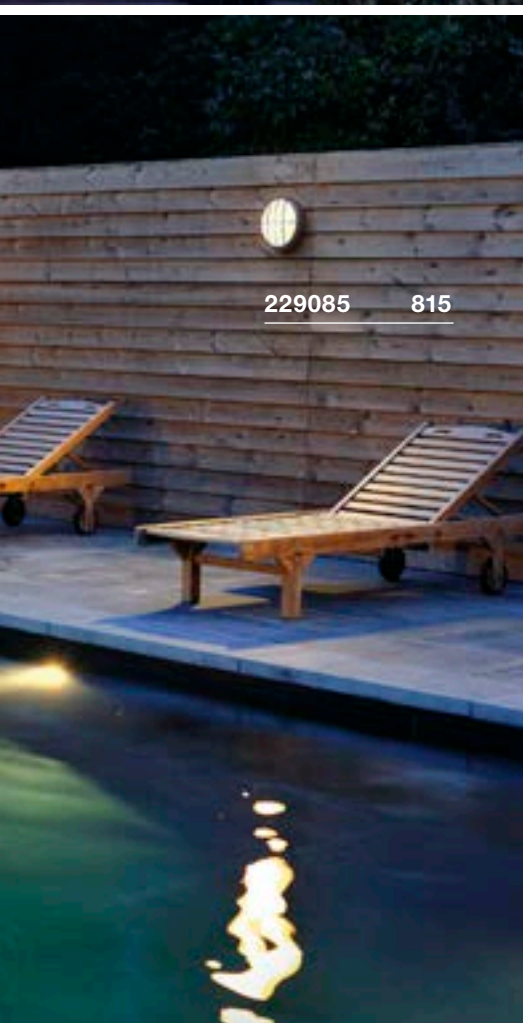

BULAN
CW, E14

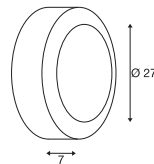

220-240V ~50/60Hz
Matière : aluminium / verre



Douille : 1xE14 Ø max. : 4,8 cm L : 13 cm

Coloris	Ref.	CHF
● anthracite	229075	78.00
○ blanc	229071	78.00
● gris	229072	78.00



C35 | 4,2W | 320°
2700K | 350lm | CEE=G
5kWh / 1000h



Ref. : 1005285 | 12.90 CHF

BULAN GRID
CW, E27

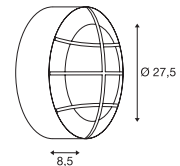

220-240V ~50/60Hz
Matière : aluminium / polycarbonate (PC)



Douilles : 2xE27 Ø max. : 5,2 cm L : 17,3 cm

Coloris	Ref.	CHF
● anthracite	229085	85.00
○ blanc	229081	85.00



| 13,5W | 240°
4000K | 1600lm | CEE=E
14kWh / 1000h



Ref. : 1005308 | 13.80 CHF



229935 817



TERANG 200 CW

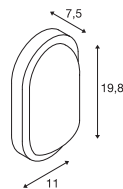

220-240V ~50/60Hz
Puissance totale : 11W
Matière : aluminium / polycarbonate (PC)



Down 830lm | 3000K

Coloris	Ref.	CHF
● anthracite	229935	99.00
○ blanc	229931	99.00

IMPERVA 120 CW

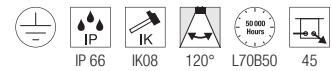
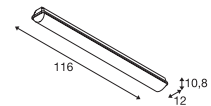

220-240V ~50/60Hz | 700mA
Puissance totale : 40W
Matière : polycarbonate (PC)



Down 4600lm | 3000K

Coloris	Ref.	CHF
● gris	1001314	138.00



233605 823



SCKET

CONCRETO | 821



LED

CONCRETO | 821



LED

ADI | 822



LED

DOWNUNDER
OUT S | 823



LED

DOWNUNDER
OUT M | 823



LED

DOWNUNDER
OUT L | 823



LED

BRICK MESH | 825



LED

BRICK | 825



LED

BRICK | 825



SCKET

BRICK
DOWNUNDER | 827



LED

BRICK
DOWNUNDER | 827



1006406 821



1006407 821



CONCRETO EL, Wing

CONCRETO EL, Cut

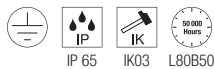
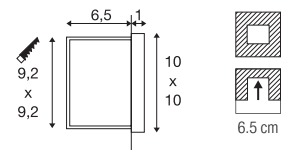
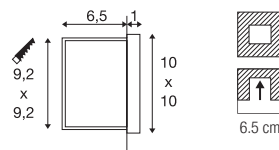

IP 65 IK03 L80B50

Aspect Wing : aile
100-240V ~50/60Hz | 700mA
Puissance totale : 3,2W
Matière : béton / aluminium

- Installation uniquement avec le faisceau vers le bas
- Pot d'encastrement inclus



Down

45lm | 3000K

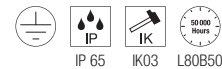

IP 65 IK03 L80B50

Aspect Cut : découpé
100-240V ~50/60Hz | 700mA
Puissance totale : 3,2W
Matière : béton / aluminium

- Installation uniquement avec le faisceau vers le bas
- Pot d'encastrement inclus



Down

15lm | 3000K

Coloris	Ref.	CHF
● gris	1006406	● 122.00

Coloris	Ref.	CHF
● gris	1006407	● 122.00

ADI
EL

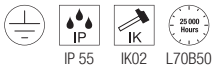
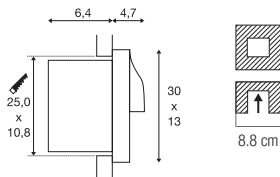

100-277V ~50/60Hz | 500mA
Puissance totale : 18W
Matière : aluminium / polycarbonate (PC)

- Installation uniquement avec le faisceau vers le bas
- Pot d'encastrement à commander séparément



Down 940lm | 3000K

Coloris	Ref.	CHF
● anthracite	233635	289.00



Article	Ref.	CHF
Pot d'encastrement ● noir	233639	24.50

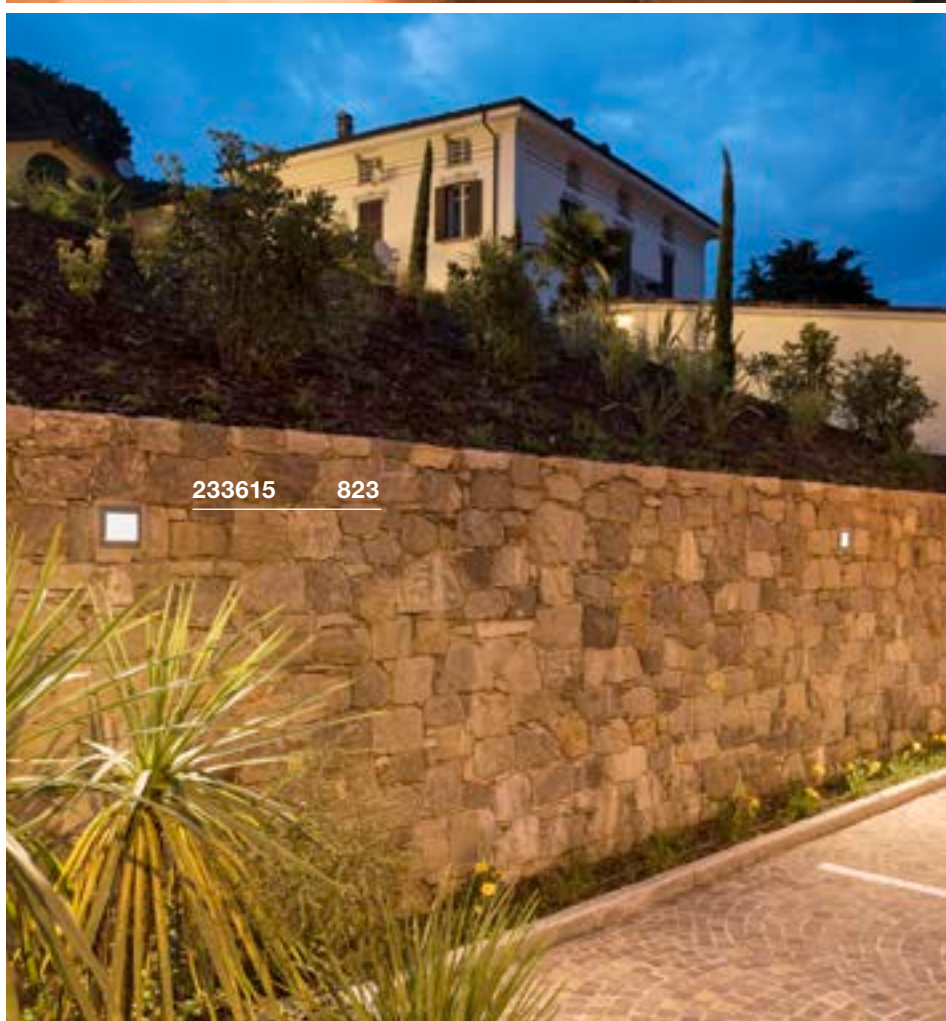



DOWNUNDER OUT S EL

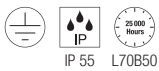
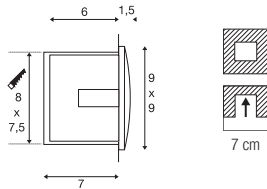

220-240V ~50/60Hz | 300mA
 Puissance totale : 1,7W
 Matière : aluminium / plastique

- Installation uniquement avec le faisceau vers le bas.
- Pot d'encastrement inclus



Down 25lm | 3000K
 65lm

Coloris	Ref.	CHF
● anthracite		
25lm	233605	79.00
○ blanc		
65lm	233601	79.00

DOWNUNDER OUT M EL

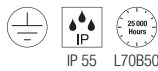
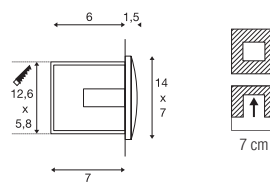

220-240V ~50/60Hz | 300mA
 Puissance totale : 4W
 Matière : aluminium / plastique

- Installation uniquement avec le faisceau vers le bas.
- Pot d'encastrement inclus



Down 85lm | 3000K
 155lm

Coloris	Ref.	CHF
● anthracite		
85 lm	233625	79.00
○ blanc		
155lm	233621	79.00

DOWNUNDER OUT L EL

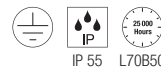
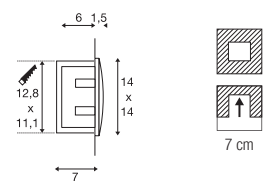

220-240V ~50/60Hz | 300mA
 Puissance totale : 4W
 Matière : aluminium / plastique

- Installation uniquement avec le faisceau vers le bas.
- Pot d'encastrement inclus



Down 85lm | 3000K

Coloris	Ref.	CHF
● anthracite	233615	117.00



233650

825



233660

825

BRICK MESH EL

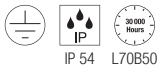
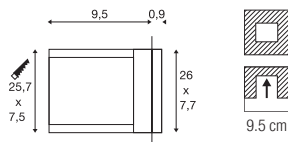
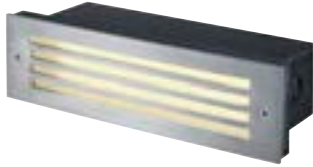

100-240V ~50/60Hz | 24V
Puissance totale : 3,3W
Matière : acier inoxydable 316 / verre

- Pot d'encastrement inclus



Down 52lm | 3000K

Coloris	Ref.	CHF
● inox	229110	279.00

BRICK EL, symétrique

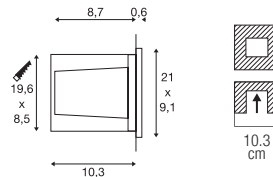

220-240V ~50/60Hz | 144mA
Puissance totale : 9,5W
Matière : aluminium / acier inoxydable 316

- Pot d'encastrement inclus



Down 950lm | 3000K

Coloris	Ref.	CHF
● inox	233650	359.00

BRICK EL, asymétrique

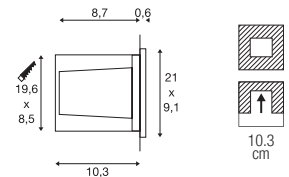

220-240V ~50/60Hz | 144mA
Puissance totale : 9,5W
Matière : aluminium / acier inoxydable 316

- Pot d'encastrement inclus



Down 850lm | 3000K

Coloris	Ref.	CHF
● inox	233660	359.00

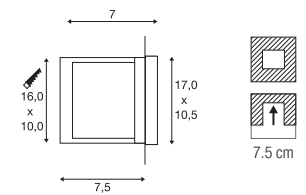
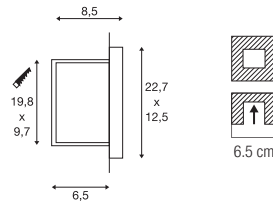

229062 827

BRICK DOWNUNDER
EL, E14BRICK DOWNUNDER
EL

IP 44 IK02 10

220-240V ~50/60Hz
Matière : aluminium / verre

- Aucun pot d'encastrement n'est requis



Douille : 1xE14 Ø max. : 4,3 cm L : 12 cm

Coloris	Ref.	CHF
● gris	229062	48.00

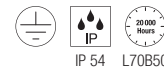

IP 54 L70B50

220-240V ~50/60Hz
Puissance totale : 1,4W
Matière : aluminium / verre

- Pot d'encastrement inclus



Down 30lm | 3000K

Coloris	Ref.	CHF
● gris	229702	85.00

C35 | 4,2W | 320°
2700K | 350lm | CEE=G
5kWh / 1000h

Ref. : 1005285 | 12.90 CHF



1006106 839



NEW

LED
DASAR® 600 | 831



NEW

LED
DASAR® 1200 | 831



NEW

LED
DASAR® S | 833



NEW

LED
DASAR® S | 833



NEW

LED
DASAR® L | 835



NEW

LED
DASAR® L | 835



NEW

LED
DASAR® XL | 837



NEW

LED
DASAR® XL | 837



LED

DASAR®
FLAT 80 | 839



LED

DASAR®
FLAT 120 | 839



LED

DASAR® 255 | 839



LED

DASAR® 920 | 840



LED

DASAR® 920 | 840



LED

DASAR® 270 | 841



LED

DASAR® 270 | 841



SCKET

DASAR® 115 | 843



SCKET

DASAR® 115 | 843



SCKET

DASAR® 115 | 843



SCKET

DASAR®
EXACT 116 | 845



SCKET

DASAR®
EXACT 116 | 845



SCKET

DASAR® 215 | 846



SCKET

DASAR® 215 | 846



SCKET

DASAR® 215 | 847



LED

DASAR® 215 | 847



LED

TRAIL-LITE® 60 | 848



LED

POWER
TRAIL-LITE® | 849



LED

POWER
TRAIL-LITE® | 849



LED

GIMBLE OUT | 849



LED

SMALL PLOT | 851



LED

SMALL PLOT | 851



SMALL PLOT | 851



SMALL PLOT | 851



LED

BIG PLOT | 853



LED

BIG PLOT | 853



BIG PLOT | 853



BIG PLOT | 853



LED

ROCCI | 854



LED

ROCCI | 854



LED

ROCCI 200 | 855



LED

ROCCI 200 | 855



SCKET

SOLASTO | 857



SCKET

SOLASTO | 857



1007196 831

DASAR® 600 EL

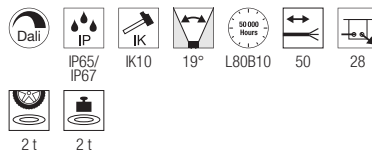
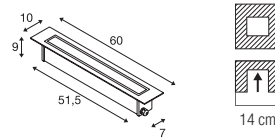

220-240V ~50/60Hz | 550mA
Puissance totale : 18W
Matière : acier inoxydable 316

- Connecteur inclus



Up 2200lm | 3000K

Coloris	Ref.	CHF
● inox	1007195	● 631.40



Article	Ref.	CHF
Pot d'encastrement		
● noir	1007198	33.40

DASAR® 1200 EL

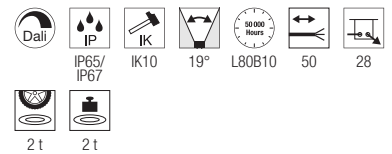
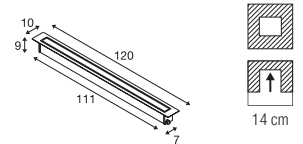

220-240V ~50/60Hz | 900mA
Puissance totale : 34W
Matière : acier inoxydable 316

- Connecteur inclus



Up 4100lm | 3000K

Coloris	Ref.	CHF
● inox	1007196	● 838.40



Article	Ref.	CHF
Pot d'encastrement		
● noir	1007197	56.40



1007680 833



DASAR® S RL, rond

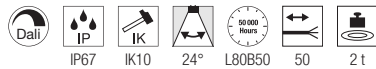
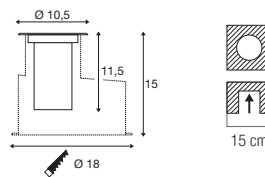

220-240V ~50/60Hz | 200mA
Puissance totale : 4W
Matière : aluminium

- Boîtier de raccordement IP



Up 350lm | 3000K

Coloris	Ref.	CHF
● anthracite	1007680	● 240.40



Article	Ref.	CHF
Pot d'encastrement S		
● noir	1007682	56.40
Réflecteur 15°		
● argent	1007683	6.90
Réflecteur 36°		
● argent	1007684	6.90
Réflecteur 50°		
● argent	1007685	6.90

DASAR® S RL, carré

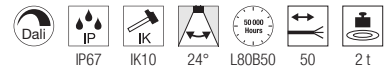
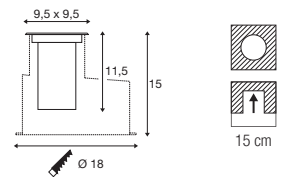

220-240V ~50/60Hz | 200mA
Puissance totale : 4W
Matière : aluminium

- Boîtier de raccordement IP



Up 350lm | 3000K

Coloris	Ref.	CHF
● anthracite	1007681	● 240.40



Article	Ref.	CHF
Pot d'encastrement S		
● noir	1007682	56.40
Réflecteur 15°		
● argent	1007683	6.90
Réflecteur 36°		
● argent	1007684	6.90
Réflecteur 50°		
● argent	1007685	6.90



1007243 835



DASAR® L RL, rond

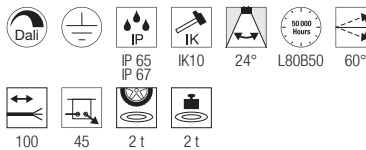
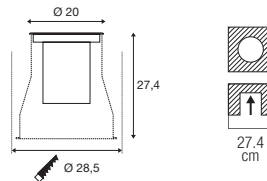

220-240V ~50/60Hz | 500mA
Puissance totale : 19W
Matière : aluminium

- Connecteur en Y inclus



Up 1950lm | 3000K

Coloris	Ref.	CHF
● inox	1007243	550.90



Article	Ref.	CHF
Pot d'encastrement pour DASAR L		
● noir	1007245	56.40
○ argent	1007238	13.80
○ argent	1007239	13.80
○ argent	1007240	13.80

DASAR® L RL, carré

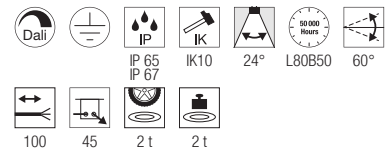
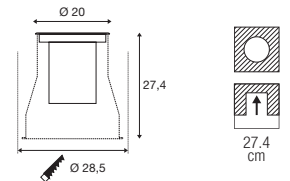

220-240V ~50/60Hz | 500mA
Puissance totale : 19W
Matière : aluminium

- Connecteur en Y inclus



Up 1950lm | 3000K

Coloris	Ref.	CHF
● noir	1007244	550.90



Article	Ref.	CHF
Pot d'encastrement pour DASAR L		
● noir	1007245	56.40
○ argent	1007238	13.80
○ argent	1007239	13.80
○ argent	1007240	13.80



1007242 837



DASAR® XL RL, rond

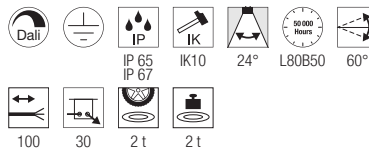
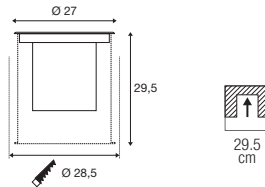

220-240V ~50/60Hz | 700mA
Puissance totale : 27W
Matière : aluminium

- Connecteur en Y inclus



Up 2790lm | 3000K

Coloris	Ref.	CHF
● inox	1007241	● 665.90



Article	Ref.	CHF
Pot d'encastrement pour DASAR XL		
● noir	1007246	67.90
○ argent	1007238	13.80
○ argent	1007239	13.80
○ argent	1007240	13.80

DASAR® XL RL, carré

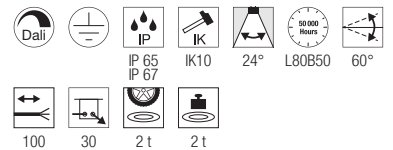
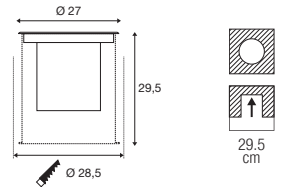

220-240V ~50/60Hz | 700mA
Puissance totale : 27W
Matière : aluminium

- Connecteur en Y inclus



Up 2790lm | 3000K

Coloris	Ref.	CHF
● inox	1007242	● 665.90



Article	Ref.	CHF
Pot d'encastrement pour DASAR XL		
● noir	1007246	67.90
○ argent	1007238	13.80
○ argent	1007239	13.80
○ argent	1007240	13.80



228412 839



229383 839



DASAR® FLAT 80 EL

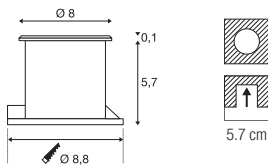

220-240V ~50/60Hz
Puissance totale : 3,5W
Matière : acier inoxydable 304 / verre

- Répond aux critères des deux indices de protection.
- Ce luminaire peut être encastré dans le bois.
- Câble nu



Up 140lm | 3000K

Coloris	Ref.	CHF
● inox	228412	156.00

DASAR® FLAT 120 EL

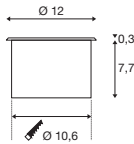

220-240V ~50/60Hz | 350mA
Puissance totale : 7W
Matière : acier inoxydable 304 / verre

- Câble nu



Up 490lm | 3000K
540lm | 4000K

Coloris	Ref.	CHF
● inox		
● 490lm 3000K	1006106	182.00
● inox		
● 540lm 4000K	1006107	182.00

DASAR® 255 EL

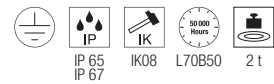
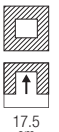
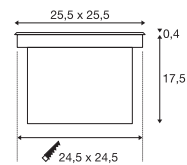

220-240V ~50/60Hz | 750mA
Puissance totale : 31W
Matière : acier inoxydable 316 / verre

- Répond aux critères des deux indices de protection.



Up 1660lm | 3000K
1720lm | 4000K

Coloris	Ref.	CHF
● inox		
● 1660lm 3000K	229383	469.00
● inox		
● 1720lm 4000K	229381	469.00



Article	Ref.	CHF
Boîte de connexion IP68, 3 pôles		
● noir	228730	21.30

DASAR® 920
EL

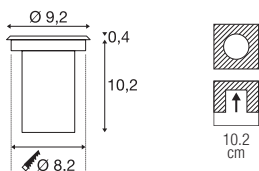

12-24V
Puissance totale : 6,5W
Matière : acier inoxydable 316 / verre

- Câble nu



Up 520lm | 3000K

Coloris	Ref.	CHF
● inox	233500	179.00



Article	Ref.	CHF
Alimentation LED 15W 12V		
○ blanc	1005444	35.00
Alimentation LED 15W 24V		
○ blanc	1005445	35.00

DASAR® 920
EL

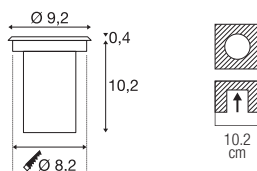

220-240V ~50/60Hz | 400mA
Puissance totale : 5,5W
Matière : acier inoxydable 316 / verre

- Câble nu



Up 300lm | 3000K

Coloris	Ref.	CHF
● inox	233520	229.00



233500 840





DASAR® 270
EL, asymétrique

DASAR® 270
EL, symétrique

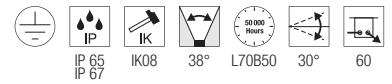
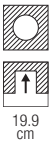
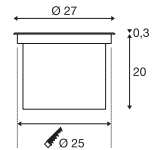
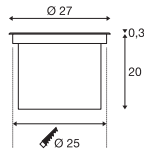

220-240V ~50/60Hz | 700mA
Puissance totale : 30W
Matière : acier inoxydable 316 / verre

220-240V ~50/60Hz | 700mA
Puissance totale : 30W
Matière : acier inoxydable 316 / verre



Up 2000lm | 3000K
2100lm | 4000K

Up 2500lm | 3000K
2600lm | 4000K

Coloris	Ref.	CHF
● inox 2000lm 3000K	1002893	539.00
● inox 2100lm 4000K	1002895	539.00

Coloris	Ref.	CHF
● inox 2500lm 3000K	1002897	539.00
● inox 2600lm 4000K	1002898	539.00



Article	Ref.	CHF
DASAR® 270 diffuseur nid d'abeille		
● noir	1002899	17.90





229320 843



DASAR® 115
RL, carré, QPAR51

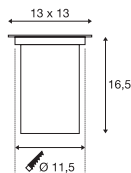

220-240V ~50/60Hz
Matière : acier inoxydable 316 / verre



Douille : 1xGU10 Ø max. : 5,1 cm L : 6 cm

Coloris	Ref.	CHF
● inox	229324	156.00

LED GU10 51mm | 6W | 38°
 2700K | 450lm | CEE=F
 6kWh / 1000h

Ref. : 1005075 | 10.60 CHF

DASAR® 115
RL, rond, QPAR51

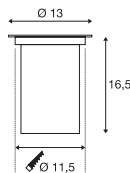

220-240V ~50/60Hz
Matière : acier inoxydable 316 / verre



Douille : 1xGU10 Ø max. : 5,1 cm L : 6 cm

Coloris	Ref.	CHF
● inox	229320	156.00

LED GU10 51mm | 6W | 38°
 2700K | 450lm | CEE=F
 6kWh / 1000h

Ref. : 1005075 | 10.60 CHF

DASAR® 115
RL, carré, QPAR51

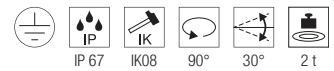
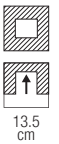
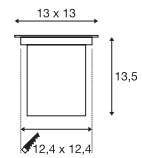

220-240V ~50/60Hz
Matière : acier inoxydable 316 / verre



Douille : 1xGU10 Ø max. : 5,1 cm L : 6 cm

Coloris	Ref.	CHF
● inox	229374	156.00

LED GU10 51mm | 6W | 38°
 2700K | 450lm | CEE=F
 6kWh / 1000h

Ref. : 1005075 | 10.60 CHF



228430 845



DASAR® EXACT 116
EL, carré, QPAR51

DASAR® EXACT 116
EL, rond, QPAR51

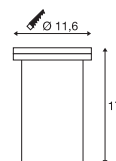
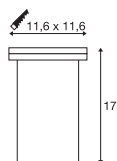

220-240V ~50/60Hz
Matière : acier inoxydable 316 / verre

220-240V ~50/60Hz
Matière : acier inoxydable 316 / verre



Douille : 1xGU10 Ø max. : 5,1 cm L : 6 cm

Douille : 1xGU10 Ø max. : 5,1 cm L : 6 cm

Coloris	Ref.	CHF
● inox	228434	169.00

Coloris	Ref.	CHF
● inox	228430	169.00



LED GU10 51mm | 6W | 38°
2700K | 450lm | CEE=F
6kWh / 1000h



Ref. : 1005077 | 10.60 CHF



LED GU10 51mm | 6W | 38°
2700K | 450lm | CEE=F
6kWh / 1000h



Ref. : 1005077 | 10.60 CHF

DASAR® 215
RL, rond, QPAR111

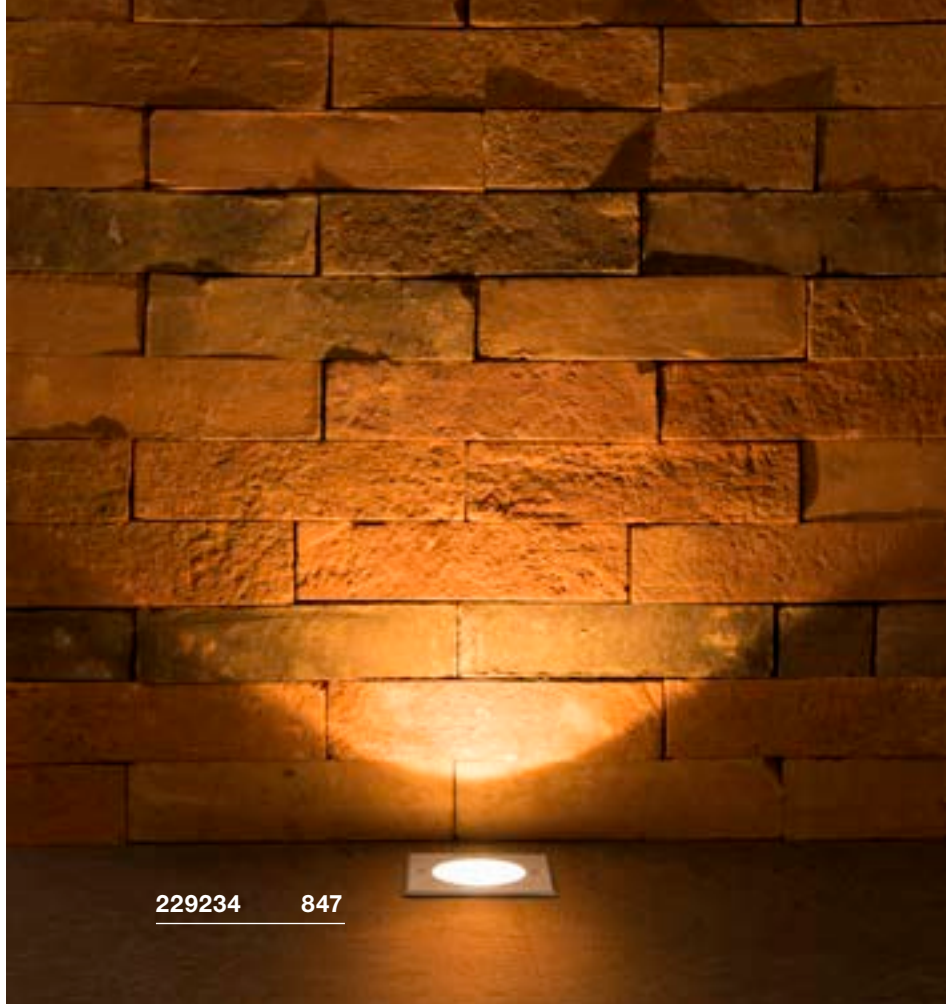
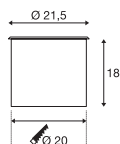

220-240V ~50/60Hz
Matière : acier inoxydable 316 / verre

SOCKET INSIDE <75 W

Douille : 1xGU10

Coloris	Ref.	CHF
● inox	229230	309.00



QPAR111 | 12,5W | 10°
3000K | 950lm | CEE=F
13kWh / 1000h



Ref. : 1005278 | 65.00 CHF





DASAR® 215
RL, carré, QPAR111

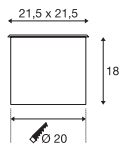

18 cm



220-240V ~50/60Hz
Matière : acier inoxydable 316 / verre



Douille : 1xGU10

Coloris	Ref.	CHF
● inox	229234	309.00



QPAR111 | 12,5W | 10°
3000K | 950lm | CEE=F
13kWh / 1000h



Ref. : 1005278 | 65.00 CHF

DASAR® 215
RL, rond, E27

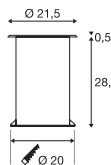

28,3 cm



220-240V ~50/60Hz
Matière : acier inoxydable 316 / verre



Douille : 1xE27 | Ø max. : 4,5 cm | L : 13,4 cm

Coloris	Ref.	CHF
● inox	229200	299.00



LED E27 | 8W | 240°
3000K | 880lm | CEE=E
8kWh / 1000h



Ref. : 1005289 | 12.90 CHF

DASAR® 370
EL, rond

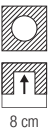
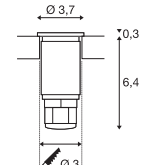

8 cm

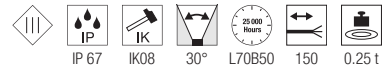

12-24V
Puissance totale : 2W
Matière : acier inoxydable 316 / verre

- Ce luminaire peut être encastré dans le bois
- Câble nu



Up | 120lm | 3000K

Coloris	Ref.	CHF
● inox	233540	209.00



Article	Ref.	CHF
Alimentation LED 15W 12V		
○ blanc	1005444	35.00
Alimentation LED 15W 24V		
○ blanc	1005445	35.00

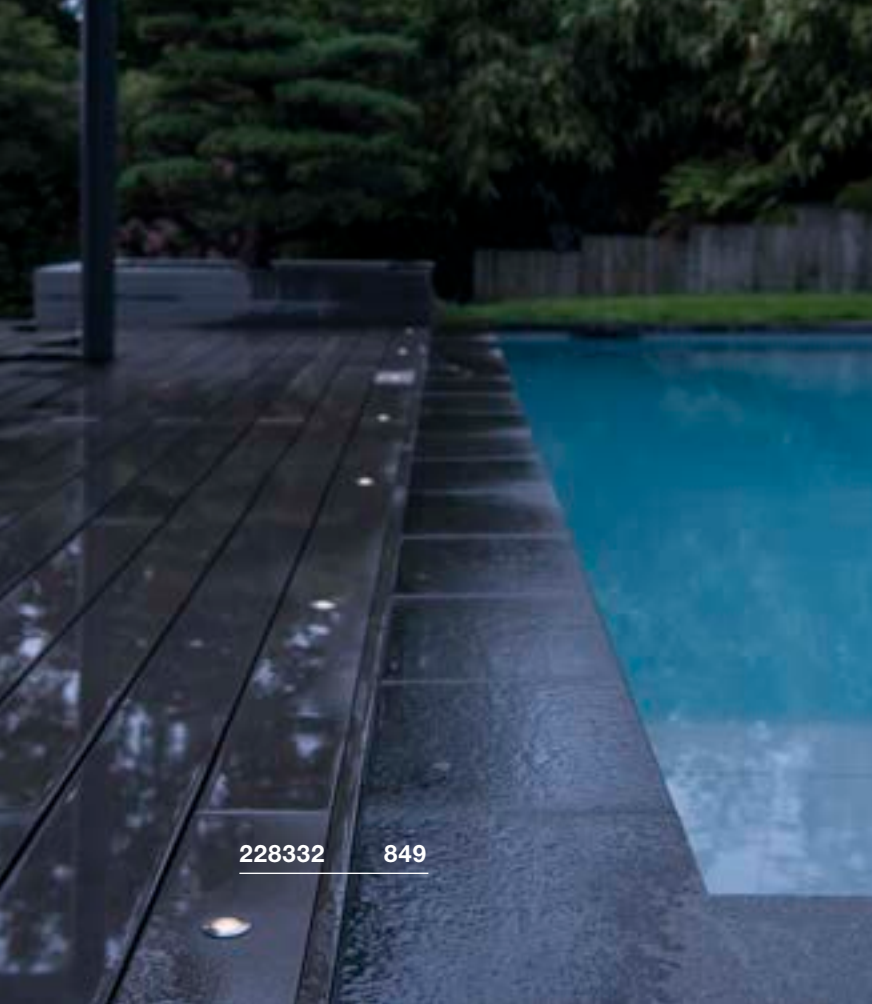

228332 849

TRAIL-LITE® 60 EL

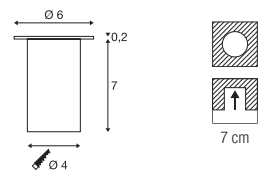

1000384 849



12V ~50/60Hz
Puissance totale : 0,3W
Matière : acier inoxydable 316 / verre

- Fonctionne uniquement avec un transformateur ferromagnétique.
- Pot d'encastrement inclus
- Ce luminaire peut être encastré dans le bois



Up

10lm | 3000K

Coloris	Ref.	CHF
● inox	227462	85.00



POWER TRAIL-LITE® EL, carré

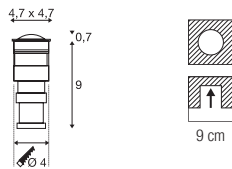

350mA
Puissance totale : 1W
Matière : acier inoxydable 316 / verre

- Fonctionne uniquement avec un driver 350mA. Câblage en série uniquement ! Pot d'encastrement inclus. Ce luminaire peut être encastré dans le bois.
- Câble nu



Up 45lm | 3000K

Coloris	Ref.	CHF
● inox	228342	106.00



Article	Ref.	CHF
Driver LED 3W 350mA		
○ blanc	1005248	21.00

POWER TRAIL-LITE® EL, rond

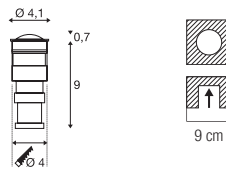

350mA
Puissance totale : 1W
Matière : acier inoxydable 316 / verre

- Fonctionne uniquement avec un driver de 350mA. Câblage en série uniquement !
- Ce luminaire peut être encastré dans le bois
- Câble nu



Up 45lm | 3000K

Coloris	Ref.	CHF
● inox	228332	106.00

GIMBLE OUT EL

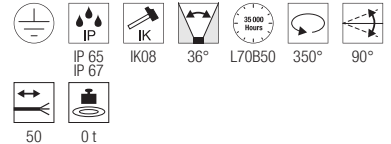
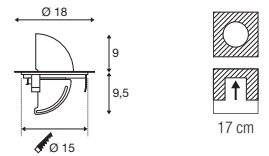

220-240V ~50/60Hz | 600mA
Puissance totale : 13W
Matière : acier inoxydable 316

- Câble nu



Up 1100lm | 3000K

Coloris	Ref.	CHF
● inox	1000384	409.00



Article	Ref.	CHF
Pot d'encastrement		
● noir	1000655	96.00
Tube d'encastrement DN160		
● gris	233792	64.00
Boîte de connexion IP68, 3 pôles		
● noir	228730	21.30



1006171 + 1006173 851

SMALL PLOT Module

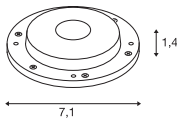

24V DC
Puissance totale : 2,6W
Matière : aluminium /
polyméthacrylate de méthyle (PMMA)

- Produit livré sans cache.
- Câble nu



Up 240lm | 3000K

Coloris	Ref.	CHF
● alu brossé	1006172	102.00



Article	Ref.	CHF
Alimentation LED 12/20W 24V, avec serre-câble		
○ blanc	1005381	49.10
Alimentation LED 15W 24V		
○ blanc	1005445	35.00

SMALL PLOT Module

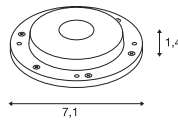

24V DC
Puissance totale : 2,6W
Matière : acier inoxydable /
polyméthacrylate de méthyle (PMMA)

- Produit livré sans cache.
- Câble nu



Up 240lm | 3000K

Coloris	Ref.	CHF
● inox	1006171	125.00



Article	Ref.	CHF
Alimentation LED 12/20W 24V, avec serre-câble		
○ blanc	1005381	49.10
Alimentation LED 15W 24V		
○ blanc	1005445	35.00

SMALL PLOT Cache, 2 fenêtres



H : 1,7 cm
Ø : 10,3 cm
Matière 1006173 : acier inoxydable
Matière 1006174 : aluminium

- Charge maximale de 500 kg pour 1006174
- Charge maximale de 800 kg pour 1006173

Coloris	Ref.	CHF
● anthracite	1006174	52.00
● inox	1006173	169.00

SMALL PLOT Cache, 4 fenêtres



H : 1,7 cm
Ø : 10,3 cm
Matière 1006175 : acier inoxydable
Matière 1006176 : aluminium

Coloris	Ref.	CHF
● anthracite	1006176	52.00
● inox	1006175	169.00



1001359 + 1001255 853



BIG PLOT Module

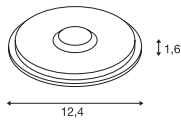

220-240V ~50/60Hz
Puissance totale : 5,5W
Matière : aluminium /
polyméthacrylate de méthyle (PMMA)

- Produit livré sans cache
- Câble nu



Up 500lm | 3000K

Coloris	Ref.	CHF
● alu brossé	1001256	117.00



Article	Ref.	CHF
Boîte de connexion en T		
● noir	228726	33.00
Boîte de connexion IP68, 3 pôles		
● noir	228730	21.30

BIG PLOT Module

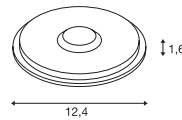

220-240V ~50/60Hz
Puissance totale : 5,5W
Matière : acier inoxydable /
polyméthacrylate de méthyle (PMMA)

- Produit livré sans cache
- Câble nu



Up 500lm | 3000K

Coloris	Ref.	CHF
● inox	1001359	160.00



Article	Ref.	CHF
Boîte de connexion en T		
● noir	228726	33.00
Boîte de connexion IP68, 3 pôles		
● noir	228730	21.30

BIG PLOT Cache, 2 fenêtres



H : 2 cm
Ø : 17 cm
Matière : aluminium

- Charge maximale de 500 kg pour 1001262
- Charge maximale de 800 kg pour 1001254

Coloris	Ref.	CHF
● anthracite	1001262	66.00
● inox	1001254	239.00

BIG PLOT Cache, 4 fenêtres



800 kg

H : 2 cm
Ø : 17 cm
Matière : acier inoxydable 316

Coloris	Ref.	CHF
● anthracite	1001263	66.00
● inox	1001255	239.00

ROCCI
EL, carré

ROCCI
EL, rond

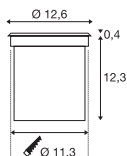
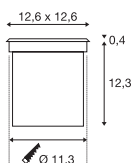

100-277V ~50/60Hz | 700mA
Puissance totale : 8,6W
Matière : acier inoxydable 316 / verre

100-277V ~50/60Hz | 700mA
Puissance totale : 8,6W
Matière : acier inoxydable 316 / verre



Up 580lm | 3000K



Up 580lm | 3000K

Coloris	Ref.	CHF
● inox	227604	219.00

Coloris	Ref.	CHF
● inox	227600	209.00

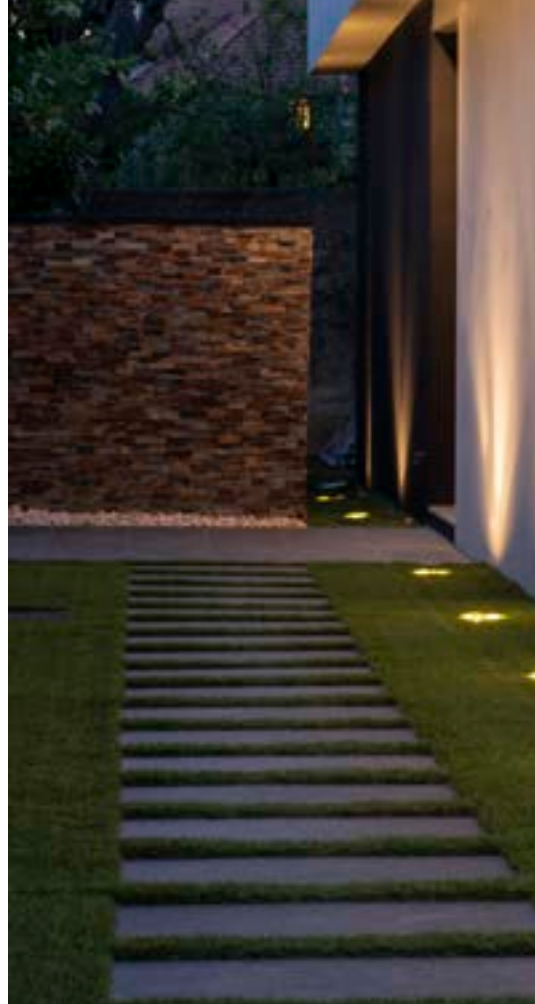



227604 854

ROCCI 200
EL, carré

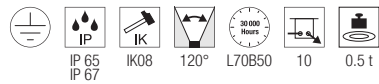
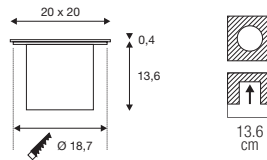

100-277V ~50/60Hz | 350mA
Puissance totale : 16W
Matière : acier inoxydable 316 / verre



Up 1530lm | 3000K

Coloris	Ref.	CHF
● inox	1006105	219.00

ROCCI 200
EL, rond

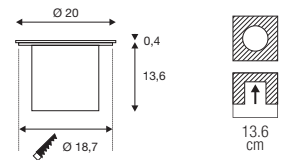

100-277V ~50/60Hz | 350mA
Puissance totale : 16W
Matière : acier inoxydable 316 / verre



Up 1530lm | 3000K

Coloris	Ref.	CHF
● inox	1006104	219.00



1006105 855



227680

857



SOLASTO EL, carré

SOLASTO EL, rond

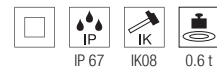
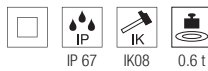
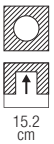
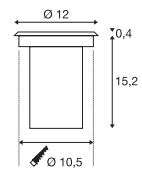
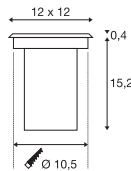

220-240V ~50/60Hz
Matière : acier inoxydable 304 / verre

220-240V ~50/60Hz
Matière : acier inoxydable 304 / verre



Douille : 1xGU10

Douille : 1xGU10

Coloris	Ref.	CHF
● inox	227684	96.00

Coloris	Ref.	CHF
● inox	227680	96.00



LED GU10 51mm | 6W | 38°
2700K | 450lm | CEE=F
6kWh / 1000h



Ref. : 1005075 | 10.60 CHF



LED GU10 51mm | 6W | 38°
2700K | 450lm | CEE=F
6kWh / 1000h



Ref. : 1005075 | 10.60 CHF

1006400 281





LED QT | 860



LED C35 | 860



LED TCR-TSE | 860



LED QR51 | 861



LED QPAR51 | 861



LED | 862

LED QPAR111 |
862, 863, 864

QPAR111 | 862, 863



LED A60 | 864, 865



LED T32 | 861



LED T38 | 865



LED T45 | 865



LED ST64 | 865



LED ST58 | 865



LED G125 | 865

LED QT14 G9



220-240V ~50/60Hz
Puissance : 3,6W
Matière : céramique
Ø : 1,8 cm L : 5,4 cm

Flux lumineux	400lm
Courant de lampe	0,03A
Indice de rendu des couleurs	93
Puissance	3,6W
Consommation d'énergie/ 1000h	4kWh

Coloris	Ref.	CHF
○ blanc		
3000K	1005286	12.90

LED QT-DE12 R7S, 78 mm



220-240V ~50/60Hz
Puissance : 9W
Matière : polycarbonate (PC)
Ø : 2,9 cm L : 2,9 cm

Flux lumineux	1050lm
Courant de lampe	0,043A
Indice de rendu des couleurs	95
Puissance	9W
Consommation d'énergie/ 1000h	9kWh

Coloris	Ref.	CHF
● gris		
3000K	1005287	27.70

LED QT-DE12 R7S, 118 mm



220-240V ~50/60Hz
Puissance : 15W
Matière : polycarbonate (PC)
Ø : 2,9 cm L : 2,9 cm

Flux lumineux	2000lm
Courant de lampe	0,068A
Indice de rendu des couleurs	92
Puissance	15W
Consommation d'énergie/ 1000h	15kWh

Coloris	Ref.	CHF
● gris		
3000K	1005288	35.00

LED C35 E14



220-240V ~50/60Hz
Puissance : 4,2W
Matière : verre
Ø : 3,5 cm L : 9,8 cm

Flux lumineux	380lm
Courant de lampe	0,025A
Indice de rendu des couleurs	90
Puissance	4,2W
Consommation d'énergie/ 1000h	5kWh

Coloris	Ref.	CHF
○ transparent		
2700K	1005284	10.60

LED C35 E14



220-240V ~50/60Hz
Puissance : 4,2W
Matière : verre
Ø : 3,5 cm L : 9,8 cm

Flux lumineux	350lm
Courant de lampe	0,025A
Indice de rendu des couleurs	90
Puissance	4,2W
Consommation d'énergie/ 1000h	5kWh

Coloris	Ref.	CHF
○ blanc		
2700K	1005285	12.90

LED TCR-TSE GX53



220-240V ~50/60Hz
Puissance : 6,1W
Matière : polycarbonate (PC) / polycarbonate (PC)
Ø : 7,5 cm L : 2,4 cm

Flux lumineux	490lm
Courant de lampe	0,034A
Indice de rendu des couleurs	93
Puissance	6,1W
Consommation d'énergie/ 1000h	6kWh

Coloris	Ref.	CHF
○ blanc		
2700K	1005272	13.50
○ blanc		
3000K	1005271	13.50
○ blanc		
4000K	1005269	13.50

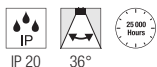
**LED QR51**
GU5.3

12V AC
Puissance : 5,8W
Matière : verre
Ø : 5 cm L : 4,5 cm

Flux lumineux	450lm
Courant de lampe	0,63A
Intensité lumineuse max.	1300cd
Indice de rendu des couleurs	90
Puissance	5,8W
Consommation d'énergie/1000h	6kWh

Coloris	Ref.	CHF
<input type="radio"/> transparent 2700K	1001574	49.10
<input type="radio"/> transparent 3000K	1001575	49.10

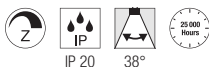
LED QPAR51
GU10, tunable 2700-6500K, smart

220-240V ~50/60Hz
Puissance : 5W
Matière : polyamide 66 (PA 66) / polycarbonate (PC)
Ø : 5 cm L : 5,4 cm

Flux lumineux	350lm
Courant de lampe	0,04A
Intensité lumineuse max.	530cd
Indice de rendu des couleurs	92
Puissance	5W
Consommation d'énergie/1000h	5kWh

Coloris	Ref.	CHF
<input type="radio"/> blanc 2700-6500K	1005311	44.90

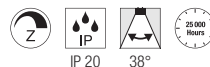
LED QPAR51
GU10, RGBW, smart

220-240V ~50/60Hz
Puissance : 5,2W
Matière : polyamide 66 (PA 66) / polycarbonate (PC)
Ø : 5 cm L : 6,1 cm

Flux lumineux	350lm
Courant de lampe	0,042A
Intensité lumineuse max.	680cd
Indice de rendu des couleurs	92
Puissance	5,2W
Consommation d'énergie/1000h	5kWh

Coloris	Ref.	CHF
<input type="radio"/> blanc	1005312	62.00

LED QPAR51
GU10

NEW



220-240V ~50/60Hz
Puissance : 2,4W
Matière : verre
Ø : 5 cm L : 5,4 cm

Flux lumineux	230lm
Courant de lampe	0.025A
Intensité lumineuse max.	450cd
Indice de rendu des couleurs	80
Puissance	2,4W
Consommation d'énergie/1000h	3kWh

Coloris	Ref.	CHF
<input type="radio"/> transparent 2700K	1007230	7.50
<input type="radio"/> transparent 3000K	1007231	7.50

LED T32
GU10

220-240V ~50/60Hz
Puissance : 3,2W
Matière : verre
Ø : 3,2 cm L : 10 cm

Flux lumineux	270lm
Courant de lampe	0.0175A
Indice de rendu des couleurs	90
Puissance	3,2W

Coloris	Ref.	CHF
<input type="radio"/> transparent 2700K	1006321	55.20

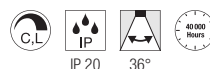
LED QPAR51
GU10

220-240V ~50/60Hz
Puissance : 6W
Matière : verre
Ø : 5 cm L : 5 cm

Flux lumineux	360lm
Courant de lampe	0.033A
Intensité lumineuse max.	680cd
Indice de rendu des couleurs	93
Puissance	6W
Consommation d'énergie/1000h	6kWh

Coloris	Ref.	CHF
<input type="radio"/> argent 2200-2700K	1005273	12.90

LED QPAR51 GU10

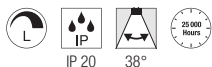

220-240V ~50/60Hz
Puissance : 6W
Matière : polycarbonate (PC)
Ø : 5 cm L : 5 cm

Flux lumineux	450lm
Courant de lampe	0.037A
Intensité lumineuse max.	880cd
Indice de rendu des couleurs	92
Puissance	6W
Consommation d'énergie/1000h	6kWh

Coloris	Ref.	CHF
● noir		
2700K	1005077	10.60
● noir		
3000K	1005080	10.60
● noir		
4000K	1005083	10.60

LED QPAR51 GU10

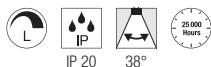

220-240V ~50/60Hz
Puissance : 6W
Matière : polycarbonate (PC)
Ø : 5 cm L : 5 cm

Flux lumineux	450lm
Courant de lampe	0.037A
Intensité lumineuse max.	880cd
Indice de rendu des couleurs	92
Puissance	6W
Consommation d'énergie/1000h	6kWh

Coloris	Ref.	CHF
○ blanc		
2700K	1005076	10.60
○ blanc		
3000K	1005079	10.60
○ blanc		
4000K	1005082	10.60

LED QPAR51 GU10

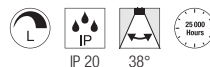

220-240V ~50/60Hz
Puissance : 6W
Matière : polycarbonate (PC)
Ø : 5 cm L : 5,4 cm

Flux lumineux	450lm
Courant de lampe	0.037A
Intensité lumineuse max.	880cd
Indice de rendu des couleurs	92
Puissance	6W
Consommation d'énergie/1000h	6kWh

Coloris	Ref.	CHF
● gris		
2700K	1005075	10.60
● gris		
3000K	1005078	10.60
● gris		
4000K	1005081	10.60

LED QPAR111 GU10

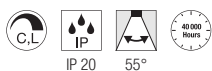

220-240V ~50/60Hz
Puissance : 12W
Matière : aluminium
Ø : 11 cm L : 7 cm

Flux lumineux	680lm
Courant de lampe	0.05A
Intensité lumineuse max.	930cd
Indice de rendu des couleurs	90
Puissance	12W
Consommation d'énergie/1000h	12kWh

Coloris	Ref.	CHF
● alu brossé		
2700K	1005297	107.00
● alu brossé		
3000K	1005298	107.00
● alu brossé		
4000K	1005299	107.00

QPAR111 GU10, RGBW, smart

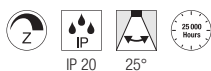

220-240V ~50/60Hz
Puissance : 10W
Matière : aluminium
Ø : 11,1 cm L : 7 cm

Flux lumineux	750lm
Courant de lampe	0.059A
Intensité lumineuse max.	3500cd
Indice de rendu des couleurs	94
Puissance	10W
Consommation d'énergie/1000h	10kWh

Coloris	Ref.	CHF
○ blanc	1005315	96.00

QPAR111 GU10, RGBW, smart

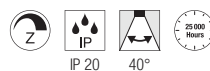

220-240V ~50/60Hz
Puissance : 10W
Matière : aluminium / polycarbonate (PC)
Ø : 11,1 cm L : 7 cm

Flux lumineux	780lm
Courant de lampe	0.059A
Intensité lumineuse max.	2000cd
Indice de rendu des couleurs	94
Puissance	10W
Consommation d'énergie/1000h	10kWh

Coloris	Ref.	CHF
○ blanc	1005316	96.00



QPAR111 GU10, tunable 2700-6500K, smart

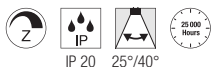

220-240V ~50/60Hz
Puissance : 10W
Matière : aluminium / polycarbonate (PC)
Ø : 11,1 cm L : 7 cm

Flux lumineux	760lm
Courant de lampe	0,053A
Intensité lumineuse max.	4000cd
Indice de rendu des couleurs	93
Puissance	10W
Consommation d'énergie/ 1000h	10kWh

Coloris	Ref.	CHF
○ blanc		
2700-6500K 25°	1005313	70.00
○ blanc		
2700-6500K 40°	1005314	70.00

LED QPAR111 GU10

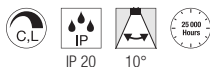

220-240V ~50/60Hz
Puissance : 12,5W
Matière : aluminium
Ø : 11,1 cm L : 7 cm

Flux lumineux	900lm
Courant de lampe	0,058A
Intensité lumineuse max.	11000cd
Indice de rendu des couleurs	90
Puissance	12,5W
Consommation d'énergie/ 1000h	13kWh

Coloris	Ref.	CHF
○ argent		
2700K	1005275	65.00
○ argent		
3000K	1005278	65.00
○ argent		
4000K	1005281	65.00

LED QPAR111 GU10

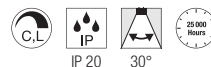

220-240V ~50/60Hz
Puissance : 12,5W
Matière : aluminium
Ø : 11,1 cm L : 7 cm

Flux lumineux	950lm
Courant de lampe	0,058A
Intensité lumineuse max.	3000cd
Indice de rendu des couleurs	93
Puissance	12,5W
Consommation d'énergie/ 1000h	13kWh

Coloris	Ref.	CHF
○ argent		
2700K	1005276	62.00
○ argent		
3000K	1005279	62.00
○ argent		
4000K	1005282	62.00

LED QPAR111 GU10

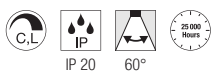

220-240V ~50/60Hz
Puissance : 12,5W
Matière : aluminium
Ø : 11,1 cm L : 7 cm

Flux lumineux	1000lm
Courant de lampe	0,058A
Intensité lumineuse max.	1000cd
Indice de rendu des couleurs	93
Puissance	12,5W
Consommation d'énergie/ 1000h	13kWh

Coloris	Ref.	CHF
○ argent		
2700K	1005277	62.00
○ argent		
3000K	1005280	62.00
○ argent		
4000K	1005283	62.00

LED QPAR111 GU10

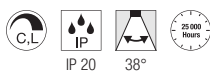

220-240V ~50/60Hz
Puissance : 8W
Matière : verre
Ø : 11,1 cm L : 6,1 cm

Flux lumineux	680lm
Courant de lampe	0,046A
Intensité lumineuse max.	1300cd
Indice de rendu des couleurs	93
Puissance	8W
Consommation d'énergie/ 1000h	8kWh

Coloris	Ref.	CHF
○ transparent		
2700K	1005274	35.20

LED QPAR111 GU10



220-240V ~50/60Hz
Puissance : 7,3W
Matière : plastique / aluminium
Ø : 11,1 cm L : 7,1 cm

Flux lumineux	530lm
Courant de lampe	0,051A
Intensité lumineuse max.	1400cd
Indice de rendu des couleurs	93
Puissance	7,3W
Consommation d'énergie/ 1000h	8kWh

Coloris	Ref.	CHF
○ argent		
2700K	1005291	24.50
○ argent		
3000K	1005292	24.50

LED QPAR111 GU10

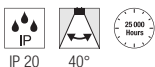

220-240V ~50/60Hz
Puissance : 7,3W
Matière : plastique / aluminium
Ø : 11,1 cm L : 7,1 cm

Flux lumineux	500lm
Courant de lampe	0.051A
Intensité lumineuse max.	1000cd
Indice de rendu des couleurs	93
Puissance	7,3W
Consommation d'énergie/1000h	8kWh

Coloris	Ref.	CHF
○ argent 2700K	1005294	24.50
○ argent 3000K	1005295	24.50
○ argent 4000K	1005296	24.50

LED A60 E27, tunable 2700-6500K, smart



220-240V ~50/60Hz
Puissance : 9W
Matière : polyamide 66 (PA 66)
Ø : 6 cm L : 11 cm

Flux lumineux	800lm
Courant de lampe	0.067A
Indice de rendu des couleurs	92
Puissance	9W
Consommation d'énergie/1000h	9kWh

Coloris	Ref.	CHF
○ blanc 2700-6500K	1005317	42.90

LED A60 E27, RGBW, smart

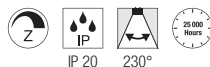

220-240V ~50/60Hz
Puissance : 9W
Matière : polyamide 66 (PA 66) / polycarbonate (PC)
Ø : 6 cm L : 11 cm

Flux lumineux	800lm
Courant de lampe	0.073A
Indice de rendu des couleurs	92
Puissance	9W
Consommation d'énergie/1000h	9kWh

Coloris	Ref.	CHF
○ blanc	1005318	59.00

LED A60 E27

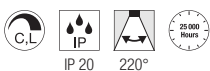

220-240V ~50/60Hz
Puissance : 9W
Matière : plastique
Ø : 6 cm L : 11 cm

Flux lumineux	800lm
Courant de lampe	0.048A
Indice de rendu des couleurs	90
Puissance	9W
Consommation d'énergie/1000h	9kWh

Coloris	Ref.	CHF
○ blanc 2700K	1005301	9.50

LED A60 E27

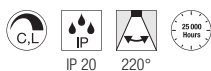

220-240V ~50/60Hz
Puissance : 13,2W
Matière : plastique
Ø : 6 cm L : 12 cm

Flux lumineux	1300lm
Courant de lampe	0.062A
Indice de rendu des couleurs	93
Puissance	13,2W
Consommation d'énergie/1000h	13kWh

Coloris	Ref.	CHF
○ blanc 2700K	1005302	17.00

LED A60 E27



220-240V ~50/60Hz
Puissance : 7,5W
Matière : verre
Ø : 6 cm L : 10,5 cm

Flux lumineux	800lm
Courant de lampe	0.038A
Indice de rendu des couleurs	93
Puissance	7,5W
Consommation d'énergie/1000h	8kWh

Coloris	Ref.	CHF
○ transparent 2700K	1005303	12.90

**LED T38**
E27

220-240V ~50/60Hz
Puissance : 8W
Matière : plastique
Ø : 3,8 cm L : 11,6 cm

Flux lumineux	880lm
Courant de lampe	0.035A
Indice de rendu des couleurs	94
Puissance	8W
Consommation d'énergie / 1000h	8kWh

Coloris	Ref.	CHF
○ blanc		
3000K	1005289	12.90
○ blanc		
4000K	1005290	12.90

LED T45
E27

220-240V ~50/60Hz
Puissance : 13,5W
Matière : plastique
Ø : 4,5 cm L : 14 cm

Flux lumineux	1520lm
Courant de lampe	0.06A
Indice de rendu des couleurs	94
Puissance	13,5W
Consommation d'énergie / 1000h	14kWh

Coloris	Ref.	CHF
○ blanc		
3000K	1005307	13.80
○ blanc		
4000K	1005308	13.80

LED ST64
E27

220-240V ~50/60Hz
Puissance : 7,5W
Matière : verre
Ø : 6,4 cm L : 14,5 cm

Flux lumineux	700lm
Courant de lampe	0.038A
Indice de rendu des couleurs	90
Puissance	7,5W
Consommation d'énergie / 1000h	8kWh

Coloris	Ref.	CHF
● or		
2500K	1005265	33.00

LED A60
E27, Tête miroir, Chrom

220-240V ~50/60Hz
Puissance : 7,5W
Matière : verre
Ø : 6 cm L : 10,5 cm

Flux lumineux	720lm
Courant de lampe	0.038A
Indice de rendu des couleurs	92
Puissance	7,5W
Consommation d'énergie / 1000h	8kWh

Coloris	Ref.	CHF
● chrome		
2700K	1005305	24.50

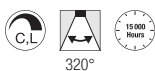
LED ST58
E27

220-240V ~50/60Hz
Puissance : 7,5W
Matière : verre
Ø : 5,8 cm L : 14,2 cm

Flux lumineux	800lm
Courant de lampe	0.038A
Indice de rendu des couleurs	93
Puissance	7,5W
Consommation d'énergie / 1000h	8kWh

Coloris	Ref.	CHF
○ transparent		
2700K	1005268	13.80

LED G125
E27

220-240V ~50/60Hz
Puissance : 7,5W
Matière : verre
Ø : 12,5 cm L : 17,8 cm

Flux lumineux	800lm
Courant de lampe	0.038A
Indice de rendu des couleurs	93
Puissance	7,5W
Consommation d'énergie / 1000h	8kWh

Coloris	Ref.	CHF
○ transparent		
2700K	1005310	27.70



1007300 151

1007308 151

1002913 189



TRANSFORMATEUR
TENSEO | 868



TRANSFORMATEUR
| 868



INTERFACE
DALI | 868



CONVERTISSEUR
| 868



VARIATEUR
UNIVERSEL DALI | 869



CONTRÔLEUR
DALI | 869



CONTRÔLEUR | 869



ALIMENTATION
LED | 869, 870, 871



ALIMENTATION LED
VARIABLE | 871, 872



DRIVER LED | 870,
872, 875, 876, 877



DRIVER LED
VARIABLE | 871, 872,
873, 874, 875



MODULE RF | 874, 875



CROCHET DE
PLAFOND | 878



SERRE-CÂBLE | 878



GLENOS®
PATÈRE | 878



CÂBLE TEXTILE | 878



CÂBLE 3 PÔLES | 878



FILIN DE SUSPENSION
MÉTALLIQUE | 878



EMBOUS
STOPPEURS POUR
CÂBLE MÉTALLIQUE
| 879



CÂBLE
D'EXTENSION | 879



FICHE DE
CONNEXION | 879



ADHÉSIF
DOUBLE-FACE | 879



DOUILLE GU10 LED
AVEC BOÎTE DE
CONNEXION | 880



DOUILLE GU10
AVEC BOÎTE DE
CONNEXION | 880



DOUILLE GU10 | 880



BOÎTE DE
CONNEXION | 881



BOÎTE DE
CONNEXION
EN T | 881



BOÎTE DE
CONNEXION | 881

**TRANSFORMATEUR
TENSEO**
12V AC | 60 VA conventionnel



220-240V ~50/60Hz
H : 11 cm
Ø : 11,1 cm
Matière : acier / laiton

Tension de sortie	12V AC
Puissance jusqu'à	60W
Protection thermique	130°C
Nombre de sorties secondaires	1

Coloris	Ref.	CHF
● noir	1002691	128.00
○ blanc	1002692	128.00
● chrome	1002693	128.00

**TRANSFORMATEUR
TENSEO**
12V AC | 105 VA conventionnel



220-240V ~50/60Hz
H : 11 cm
Ø : 11,1 cm
Matière : laiton / verre

Tension de sortie	12V AC
Puissance jusqu'à	105W
Protection thermique	130°C
Nombre de sorties secondaires	1

Coloris	Ref.	CHF
○ blanc	138981	160.00
● chrome	138982	169.00

**TRANSFORMATEUR
TENSEO**
12V AC | 210 VA conventionnel



220-240V ~50/60Hz
H : 11 cm
Ø : 13,5 cm
Matière : acier / laiton

Tension de sortie	12V AC
Puissance jusqu'à	210W
Protection thermique	130°C
Nombre de sorties secondaires	1

Coloris	Ref.	CHF
○ blanc	138991	249.00
● chrome	138992	249.00

TRANSFORMATEUR
60VA | 12V AC



230V ~50Hz
L : 10,5 cm l : 3,3 cm H : 2,2 cm
Matière : polycarbonate (PC)

Tension de sortie	12V AC
Puissance de	10W
Puissance jusqu'à	60W
Facteur de puissance de l'appareil	0.98
Protection thermique	110°C
Nombre de sorties secondaires	1

Coloris	Ref.	CHF
○ blanc	461060	24.50

INTERFACE DALI
1-10V + on/off



250V AC
L : 5,85 cm l : 3,25 cm H : 1,5 cm
Matière : plastique

- Permet de contrôler des alimentations électroniques avec une entrée de commande 1-10V
- Isolation galvanique de l'entrée DALI et de la sortie 1-10V

Tension de sortie	250V AC
Puissance jusqu'à	1000W

Coloris	Ref.	CHF
● gris	1002218	179.00

CONVERTISSEUR
Phase dim -> DALI



100-240V ~50/60Hz
L : 4,6 cm l : 4,5 cm H : 2 cm
Matière : polycarbonate (PC)

Tension de sortie	100-240V AC
Puissance de	0W
Puissance jusqu'à	200W

Coloris	Ref.	CHF
○ blanc	1006452	135.00



VARIATEUR UNIVERSEL DALI 10-300W



230V AC
L : 12,02 cm l : 3,02 cm H : 2,16 cm
Matière : plastique

- Convient au R.L.C. grâce à la détection automatique de la charge. Consommation DALI : 6 mA

Tension de sortie	230V AC
Puissance de	10W
Puissance jusqu'à	300W

Coloris	Ref.	CHF
● gris	1002221	229.00

CONTRÔLEUR DALI 24V DC

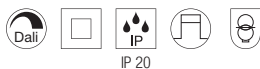

10 V-24V DC
L : 11,6 cm l : 4,2 cm H : 1,8 cm
Matière : polycarbonate (PC)

Tension de sortie	10-24V DC
Nombre de sorties secondaires	1

Coloris	Ref.	CHF
○● blanc / gris	1003106	78.00

CONTRÔLEUR LED Stip CCT / RGBW



NEW



12 V/24V DC
L : 14,5 cm l : 4,65 cm H : 1,6 cm
Matière : polycarbonate (PC)

Tension de sortie	12-24V DC
Puissance de	48W
Puissance jusqu'à	96W
Protection thermique	100°C

Coloris	Ref.	CHF
○ blanc	1006348	95.90

ALIMENTATION LED 15W | 12V

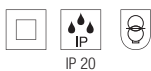

200-240V ~50/60Hz
H : 2,5 cm
Ø : 5,5 cm
Matière : polycarbonate (PC)

Tension de sortie	12V DC
Puissance de	0W
Puissance jusqu'à	15W
Facteur de puissance de l'appareil	0,9
Protection thermique	110°C
Nombre de sorties secondaires	1

Coloris	Ref.	CHF
○ blanc	1005444	35.00

ALIMENTATION LED 15W | 24V

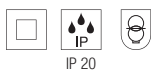

200-240V ~50/60Hz
H : 2,2 cm
Ø : 5,5 cm
Matière : polycarbonate (PC)

Tension de sortie	24V DC
Puissance de	0W
Puissance jusqu'à	15W
Facteur de puissance de l'appareil	0,9
Protection thermique	110°C
Nombre de sorties secondaires	1

Coloris	Ref.	CHF
○ blanc	1005445	35.00

ALIMENTATION LED 20W | 12/24V

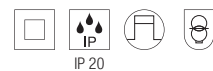

220-240V ~50/60Hz
L : 11,5 cm l : 4,1 cm H : 2,5 cm
Matière : polycarbonate (PC)

Tension de sortie	12/24V DC
Puissance de	0W
Puissance jusqu'à	18W/20W
Facteur de puissance de l'appareil	0,95
Protection thermique	110°C
Nombre de sorties secondaires	1

Coloris	Ref.	CHF
○ blanc	1005381	49.10

DRIVER LED
30W | 24V DC avec serre-câble



220-240V ~50/60Hz
L : 30 cm l : 3 cm H : 1,6 cm
Matière : polycarbonate (PC)

Tension de sortie	24V DC
Puissance de	0W
Puissance jusqu'à	30W
Facteur de puissance de l'appareil	0.95
Protection thermique	110°C
Nombre de sorties secondaires	1

Coloris	Ref.	CHF
<input type="radio"/> blanc	1007250	57.50

DRIVER LED
100W | 24V DC avec serre-câble



220-240V ~50/60Hz
L : 35 cm l : 3 cm H : 1,8 cm
Matière : polycarbonate (PC)

Tension de sortie	24V DC
Puissance de	0W
Puissance jusqu'à	100W
Facteur de puissance de l'appareil	0.95
Protection thermique	110°C
Nombre de sorties secondaires	1

Coloris	Ref.	CHF
<input type="radio"/> blanc	1007251	92.00

DRIVER LED
150W | 24V DC avec serre-câble



220-240V ~50/60Hz
L : 35 cm l : 3 cm H : 1,8 cm
Matière : polycarbonate (PC)

Tension de sortie	24V DC
Puissance de	0W
Puissance jusqu'à	150W
Facteur de puissance de l'appareil	0.95
Protection thermique	110°C
Nombre de sorties secondaires	1

Coloris	Ref.	CHF
<input type="radio"/> blanc	1007252	115.00

DRIVER LED
250W | 24V DC avec serre-câble



220-240V ~50/60Hz
L : 40 cm l : 4 cm H : 2,2 cm
Matière : polycarbonate (PC)

Tension de sortie	24V DC
Puissance de	0W
Puissance jusqu'à	250W
Facteur de puissance de l'appareil	0.95
Protection thermique	110°C
Nombre de sorties secondaires	1

Coloris	Ref.	CHF
<input type="radio"/> blanc	1007253	138.00

ALIMENTATION LED
25W | 24V

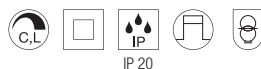

220-240V ~50/60Hz
L : 12,8 cm l : 5,2 cm H : 3 cm
Matière : polycarbonate (PC) / polycarbonate (PC)

Tension de sortie	24V DC
Puissance de	9.6W
Puissance jusqu'à	25W
Facteur de puissance de l'appareil	0.95
Protection thermique	110°C
Nombre de sorties secondaires	1

Coloris	Ref.	CHF
<input type="radio"/> blanc / gris	1006336	41.90

ALIMENTATION LED
50W | 24V

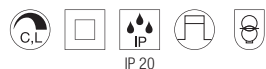

220-240V ~50/60Hz
L : 18,4 cm l : 6,1 cm H : 3,2 cm
Matière : polycarbonate (PC) / polycarbonate (PC)

Tension de sortie	24V DC
Puissance de	12W
Puissance jusqu'à	50W
Facteur de puissance de l'appareil	0.95
Protection thermique	110°C
Nombre de sorties secondaires	1

Coloris	Ref.	CHF
<input type="radio"/> blanc / bleu	1003104	64.00



ALIMENTATION LED 100W | 24V DC



220-240V ~50/60Hz
L : 21 cm l : 6,7 cm H : 3,4 cm
Matière : polycarbonate (PC) /
polycarbonate (PC)

Tension de sortie	24V DC
Puissance de	33W
Puissance jusqu'à	100W
Facteur de puissance de l'appareil	0.95
Protection thermique	110°C
Nombre de sorties secondaires	1

Coloris	Ref.	CHF
○ blanc / bleu	1003105	149.00

DRIVER LED 30W | 24V DC à variation DALI, avec serre-câble



220-240V ~50/60Hz
L : 30 cm l : 3 cm H : 1,6 cm
Matière : polycarbonate (PC)

Tension de sortie	24V DC
Puissance de	12W
Puissance jusqu'à	30W
Facteur de puissance de l'appareil	0.95
Protection thermique	110°C
Nombre de sorties secondaires	1

Coloris	Ref.	CHF
○ blanc	1007254	69.00

DRIVER LED 100W | 24V DC à variation DALI, avec serre-câble

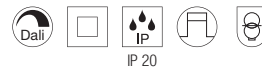

220-240V ~50/60Hz
L : 35 cm l : 3 cm H : 1,8 cm
Matière : polycarbonate (PC)

Tension de sortie	24V DC
Puissance de	30W
Puissance jusqu'à	100W
Facteur de puissance de l'appareil	0.95
Protection thermique	110°C
Nombre de sorties secondaires	1

Coloris	Ref.	CHF
○ blanc	1007255	126.50

DRIVER LED 150W | 24V DC à variation DALI, avec serre-câble

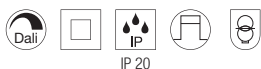

220-240V ~50/60Hz
L : 35 cm l : 3 cm H : 1,8 cm
Matière : polycarbonate (PC)

Tension de sortie	24V DC
Puissance de	45W
Puissance jusqu'à	150W
Facteur de puissance de l'appareil	0.95
Protection thermique	110°C
Nombre de sorties secondaires	1

Coloris	Ref.	CHF
○ blanc	1007256	161.00

DRIVER LED 250W | 24V DC à variation DALI, avec serre-câble

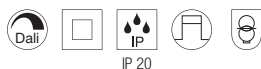

220-240V ~50/60Hz
L : 40 cm l : 4 cm H : 2,2 cm
Matière : polycarbonate (PC)

Tension de sortie	24V DC
Puissance de	75W
Puissance jusqu'à	250W
Facteur de puissance de l'appareil	0.95
Protection thermique	110°C
Nombre de sorties secondaires	1

Coloris	Ref.	CHF
○ blanc	1007257	184.00

ALIMENTATION LED 60W | variation DALI, 24V, 2 canaux

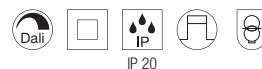

220-240V ~50/60Hz
L : 20,2 cm l : 5,8 cm H : 3 cm
Matière : polycarbonate (PC)

Tension de sortie	24V DC
Puissance de	5W
Puissance jusqu'à	60W
Facteur de puissance de l'appareil	0.95
Protection thermique	110°C
Nombre de sorties secondaires	2

Coloris	Ref.	CHF
○ blanc	1006133	182.00

ALIMENTATION LED
100W | 24V | variation DALI,
2 canaux

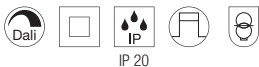

220-240V ~50/60Hz
L : 34,7 cm l : 4 cm H : 2,2 cm
Matière : polycarbonate (PC)

Puissance de	5W
Puissance jusqu'à	100W
Facteur de puissance de l'appareil	0.95
Protection thermique	110°C
Nombre de sorties secondaires	2

Coloris	Ref.	CHF
<input type="radio"/> blanc	1006134	209.00

DRIVER LED
10W | 200mA | variable,
avec serre-câble



220-240V ~50/60Hz
L : 8,5 cm l : 4,1 cm H : 2,2 cm
Matière : polycarbonate (PC)

Tension de sortie	30-42V DC
Puissance de	6W
Puissance jusqu'à	8.4W
Facteur de puissance de l'appareil	0.9
Protection thermique	110°C
Nombre de sorties secondaires	1

Coloris	Ref.	CHF
<input type="radio"/> blanc	1007215	40.30

DRIVER LED
6W | 350mA | variable



220-240V ~50/60Hz
L : 6,3 cm l : 4 cm H : 2,3 cm
Matière : polycarbonate (PC)

Tension de sortie	10-17V DC
Puissance de	3.5W
Puissance jusqu'à	5.9W
Facteur de puissance de l'appareil	0.9
Protection thermique	110°C
Nombre de sorties secondaires	1

Coloris	Ref.	CHF
<input type="radio"/> blanc	1002791	35.20

DRIVER LED
20W | 350mA | variable



220-240 V 0/~50/60Hz
L : 11,6 cm l : 4,1 cm H : 2,5 cm
Matière : polycarbonate (PC)

Tension de sortie	28-50V DC
Puissance de	9.8W
Puissance jusqu'à	17.5W
Facteur de puissance de l'appareil	0.95
Protection thermique	110°C
Nombre de sorties secondaires	1

Coloris	Ref.	CHF
<input type="radio"/> blanc	1007228	46.00

DRIVER LED
20W | 350mA/500mA | PHASE



220-240 V 0/~50/60Hz
L : 11,6 cm l : 4,1 cm H : 2,5 cm
Matière : polycarbonate (PC)

Tension de sortie	10-30V DC
Puissance de	3.5W
Puissance jusqu'à	15W
Facteur de puissance de l'appareil	0.95
Protection thermique	110°C
Nombre de sorties secondaires	1

Coloris	Ref.	CHF
<input type="radio"/> blanc	1007227	46.00

DRIVER LED
700mA | PHASE

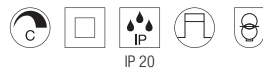

220-240V ~50/60Hz
L : 8,5 cm l : 4,1 cm H : 2,2 cm
Matière : polycarbonate (PC)

Tension de sortie	8.6-12.9V DC
Puissance de	6W
Puissance jusqu'à	9W
Facteur de puissance de l'appareil	0.9
Protection thermique	110°C
Nombre de sorties secondaires	1

Coloris	Ref.	CHF
<input type="radio"/> blanc	1007213	40.30



DRIVER LED

20W | 700mA | variable

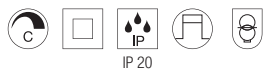

200-240V ~50/60Hz
L : 11,5 cm l : 4,1 cm H : 2,5 cm
Matière : polycarbonate (PC)

Tension de sortie	18-26V DC
Puissance de	12.6W
Puissance jusqu'à	18.2W
Facteur de puissance de l'appareil	0.9
Protection thermique	110°C
Nombre de sorties secondaires	1

Coloris	Ref.	CHF
○ blanc	1006202	42.90

DRIVER LED

40W | 700mA | variable

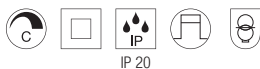

200-240V ~50/60Hz
L : 14,5 cm l : 4 cm H : 3 cm
Matière : polycarbonate (PC)

Tension de sortie	32-54V DC
Puissance de	22.4W
Puissance jusqu'à	37.8W
Facteur de puissance de l'appareil	0.9
Protection thermique	110°C
Nombre de sorties secondaires	1

Coloris	Ref.	CHF
○ blanc	1005446	55.00

DRIVER LED

40W | 1050mA | variable

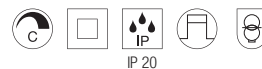

220-240V ~50/60Hz
L : 16,6 cm l : 5,2 cm H : 2,4 cm
Matière : polycarbonate (PC)

Tension de sortie	22-43V DC
Puissance de	23W
Puissance jusqu'à	45W
Facteur de puissance de l'appareil	0.95
Protection thermique	110°C
Nombre de sorties secondaires	1

Coloris	Ref.	CHF
○ blanc	464804	70.00

DRIVER LED

40W | 1000mA | variable

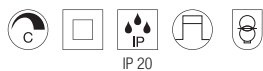

220-240V ~50/60Hz
L : 14,5 cm l : 4 cm H : 3 cm
Matière : polycarbonate (PC)

Tension de sortie	25-40V DC
Puissance de	26.3W
Puissance jusqu'à	42W
Facteur de puissance de l'appareil	0.9
Protection thermique	110°C
Nombre de sorties secondaires	1

Coloris	Ref.	CHF
○ blanc	1005387	65.00

DRIVER LED

25W | 150-700mA | variable DALI

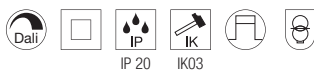

220-240 V 0/~50/60Hz
L : 11,9 cm l : 5,2 cm H : 2,25 cm
Matière : polycarbonate (PC)

Tension de sortie	2-50V DC
Puissance de	0.3W
Puissance jusqu'à	25W
Facteur de puissance de l'appareil	0.95
Protection thermique	110°C
Nombre de sorties secondaires	1

Coloris	Ref.	CHF
○ blanc	1007229	80.50

DRIVER LED

25W | 150-300mA | variable DALI

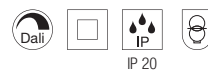

220-240V ~50/60Hz
L : 14,18 cm l : 4,38 cm H : 3 cm
Matière : polycarbonate (PC)

Tension de sortie	10-40V DC
Puissance de	1.5W
Puissance jusqu'à	12W
Facteur de puissance de l'appareil	0.9
Protection thermique	110°C
Nombre de sorties secondaires	1

Coloris	Ref.	CHF
○ blanc	1006456	105.00

MODULE RF pour driver DALI



NEW



L : 4,3 cm l : 3,1 cm H : 1,2 cm
Matière : polycarbonate (PC)

- Zigbee 3.0 Simple Color

MODULE RF pour driver DALI



NEW

L : 4,3 cm l : 3,1 cm H : 1,2 cm
Matière : polycarbonate (PC)

- Casambi

DRIVER LED 12W | 250mA DALI variable avec interface RF



NEW



220-240V ~50/60Hz
L : 14,18 cm l : 4,38 cm H : 3 cm
Matière : polycarbonate (PC)

Tension de sortie	10-40V DC
Puissance de	1,5W
Puissance jusqu'à	12W
Facteur de puissance de l'appareil	0,9
Protection thermique	110°C
Nombre de sorties secondaires	1

Coloris	Ref.	CHF
<input type="radio"/> blanc	1006199	43.70

Coloris	Ref.	CHF
<input type="radio"/> blanc	1006454	148.40

Coloris	Ref.	CHF
<input type="radio"/> blanc	1006194	105.00

DRIVER LED 40W | 500mA DALI variable avec interface RF



NEW

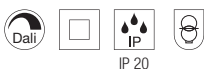

220-240V ~50/60Hz
L : 12,3 cm l : 7,9 cm H : 3 cm
Matière : polycarbonate (PC)

Tension de sortie	10-42V DC
Puissance de	5W
Puissance jusqu'à	42W
Facteur de puissance de l'appareil	0,95
Protection thermique	110°C
Nombre de sorties secondaires	1

Coloris	Ref.	CHF
<input type="radio"/> blanc	1006195	125.00

DRIVER LED 40W | 700mA DALI variable avec interface RF



NEW



220-240V ~50/60Hz
L : 12,3 cm l : 7,9 cm H : 3 cm
Matière : polycarbonate (PC)

Tension de sortie	10-42V DC
Puissance de	5W
Puissance jusqu'à	42W
Facteur de puissance de l'appareil	0,95
Protection thermique	110°C
Nombre de sorties secondaires	1

Coloris	Ref.	CHF
<input type="radio"/> blanc	1006196	125.00

DRIVER LED 40W | 1050mA DALI variable avec interface RF



NEW



220-240V ~50/60Hz
L : 12,3 cm l : 7,9 cm H : 3 cm
Matière : polycarbonate (PC)

Tension de sortie	10-40V DC
Puissance de	5W
Puissance jusqu'à	42W
Facteur de puissance de l'appareil	0,95
Protection thermique	110°C
Nombre de sorties secondaires	1

Coloris	Ref.	CHF
<input type="radio"/> blanc	1006197	125.00



DRIVER LED

20W | 250-700mA variable 1-10 V/ DALI



220-240V ~50/60Hz
L : 15 cm l : 5,2 cm H : 2,8 cm
Matière : polycarbonate (PC)

Tension de sortie	6-60V DC
Puissance de	1.5W
Puissance jusqu'à	20W
Facteur de puissance de l'appareil	0.9
Protection thermique	110°C
Nombre de sorties secondaires	1

Coloris	Ref.	CHF
○ blanc	1002423	117.00

DRIVER LED

40W | 500-1050mA variable 1-10 V/DALI



220-240V ~50/60Hz
L : 12,3 cm l : 7,9 cm H : 2,4 cm
Matière : polycarbonate (PC)

Tension de sortie	9-58V DC
Puissance de	4.5W
Puissance jusqu'à	40W
Facteur de puissance de l'appareil	0.9
Protection thermique	110°C
Nombre de sorties secondaires	1

Coloris	Ref.	CHF
○ blanc	1002424	117.00

DRIVER LED

50W | 700-1500mA variable 1-10 V/DALI

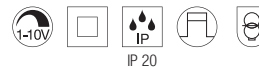

220-240V ~50/60Hz
L : 12,3 cm l : 7,9 cm H : 2,4 cm
Matière : polycarbonate (PC)

Tension de sortie	6-58V DC
Puissance de	4.2W
Puissance jusqu'à	50W
Facteur de puissance de l'appareil	0.9
Protection thermique	110°C
Nombre de sorties secondaires	1

Coloris	Ref.	CHF
○ blanc	1002425	127.00

DRIVER LED

40W | 1050mA DALI CCT tunable



NEW

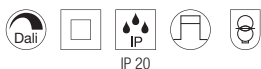

220-240V ~50/60Hz
L : 12,3 cm l : 7,9 cm H : 3 cm
Matière : polycarbonate (PC)

Tension de sortie	10-40V DC
Puissance de	5W
Puissance jusqu'à	42W
Facteur de puissance de l'appareil	0.9
Protection thermique	110°C
Nombre de sorties secondaires	7

Coloris	Ref.	CHF
○ blanc	1006198	178.30

MODULE RF

pour driver DALI



NEW



L : 4,3 cm l : 3,1 cm H : 1,2 cm
Matière : polycarbonate (PC)

- Zigbee 3.0 Dual Color

Coloris	Ref.	CHF
○ blanc	1006455	43.70

DRIVER LED

10W | 250mA



220-240V ~50/60Hz
L : 6,5 cm l : 3,9 cm H : 2 cm
Matière : polycarbonate (PC)

Tension de sortie	26-40V DC
Puissance de	6.5W
Puissance jusqu'à	10W
Facteur de puissance de l'appareil	0.9
Protection thermique	110°C
Nombre de sorties secondaires	1

Coloris	Ref.	CHF
○ blanc	1004780	33.00

DRIVER LED
3W | 350mA



100-240V ~50/60Hz
L : 6,5 cm l : 2,9 cm H : 1,8 cm
Matière : polycarbonate (PC)

Tension de sortie	2,7-10V DC
Puissance de	1W
Puissance jusqu'à	3,5W
Facteur de puissance de l'appareil	0.4
Protection thermique	110°C
Nombre de sorties secondaires	1

Coloris	Ref.	CHF
<input type="radio"/> blanc	1005248	21.00

DRIVER LED
3W | 350mA avec fiche AMP



100-240V ~50/60Hz
L : 6,5 cm l : 2,9 cm H : 1,8 cm
Matière : polycarbonate (PC)

Tension de sortie	2.7-10V DC
Puissance de	1W
Puissance jusqu'à	3.5W
Facteur de puissance de l'appareil	0.4
Protection thermique	110°C
Nombre de sorties secondaires	1

Coloris	Ref.	CHF
<input type="radio"/> blanc	1007270	22.80

DRIVER LED
20W | 350mA



220-240 V 0/~50/60Hz
L : 11,6 cm l : 4,1 cm H : 2,5 cm
Matière : polycarbonate (PC)

Tension de sortie	2-54V DC
Puissance de	0.7W
Puissance jusqu'à	19W
Facteur de puissance de l'appareil	0.95
Protection thermique	110°C
Nombre de sorties secondaires	1

Coloris	Ref.	CHF
<input type="radio"/> blanc	1007225	34.50

DRIVER LED
21W | 500mA avec serre-câble



220-240V 0/~50/60Hz
L : 11,6 cm l : 4,1 cm H : 2,5 cm
Matière : polycarbonate (PC)

Tension de sortie	2-42V DC
Puissance de	1W
Puissance jusqu'à	21W
Facteur de puissance de l'appareil	0.95
Protection thermique	110°C
Nombre de sorties secondaires	1

Coloris	Ref.	CHF
<input type="radio"/> blanc	1007226	34.50

DRIVER LED
3W | 700mA avec serre-câble

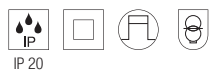

100-240V ~50/60Hz
L : 6,5 cm l : 2,9 cm H : 1,8 cm
Matière : polycarbonate (PC)

Tension de sortie	2,7-4V DC
Puissance de	1.9W
Puissance jusqu'à	2.8W
Facteur de puissance de l'appareil	0.4
Protection thermique	110°C
Nombre de sorties secondaires	1

Coloris	Ref.	CHF
<input type="radio"/> blanc	1007216	26.50

DRIVER LED
30W | 700mA



220-240V ~50/60Hz
L : 14,7 cm l : 4,3 cm H : 3 cm
Matière : polycarbonate (PC)

Tension de sortie	30-42V DC
Puissance de	21W
Puissance jusqu'à	29,5W
Facteur de puissance de l'appareil	0.9
Protection thermique	110°C
Nombre de sorties secondaires	1

Coloris	Ref.	CHF
<input type="radio"/> blanc	1004781	41.60

**DRIVER LED**
40W | 1050mA

220-240V ~50/60Hz
L : 14,7 cm l : 4,3 cm H : 3 cm
Matière : polycarbonate (PC)

Tension de sortie	30-42V DC
Puissance de	31.5W
Puissance jusqu'à	44W
Facteur de puissance de l'appareil	0.9
Protection thermique	110°C
Nombre de sorties secondaires	1

Coloris	Ref.	CHF
<input type="radio"/> blanc	1004782	49.10

DRIVER LED
40W | 700/900/1000mA

120-277V ~50/60Hz
L : 12,3 cm l : 7,9 cm H : 3 cm
Matière : polycarbonate (PC)

Tension de sortie	28-52V DC
Puissance de	19.6W
Puissance jusqu'à	40W
Facteur de puissance de l'appareil	0.9
Protection thermique	110°C
Nombre de sorties secondaires	3

Coloris	Ref.	CHF
<input type="radio"/> blanc	1006120	65.00

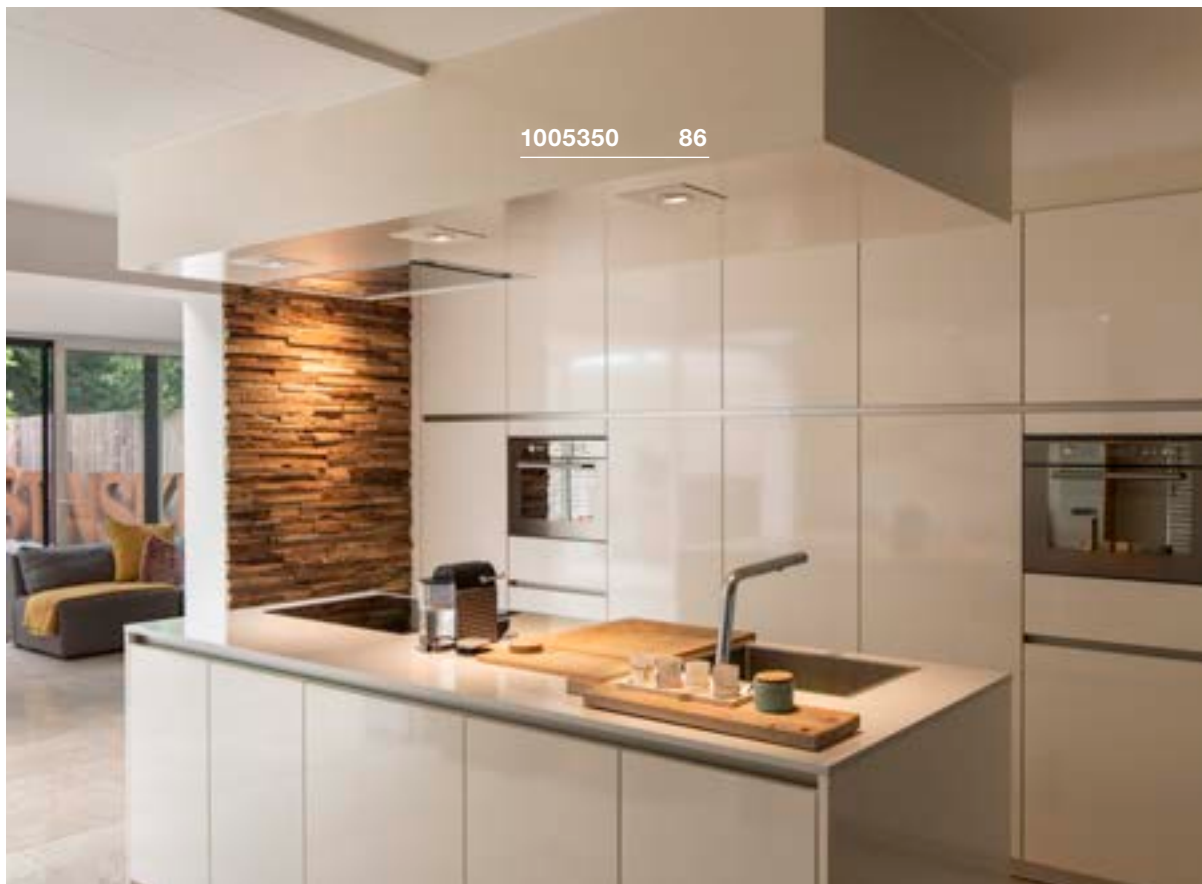

1005350 **86**

CROCHET DE PLAFOND



L : 4,6 cm
 Ø : 1,8 cm
 Matière : aluminium

Coloris	Ref.	CHF
● noir	132670	24.50
○ blanc	132671	24.50

SERRE-CÂBLE



L : 3,1 cm
 Ø : 1,4 cm
 Matière : aluminium

Coloris	Ref.	CHF
● noir	132680	17.00
○ blanc	132681	17.00

GLENOS® Patère



220-240V ~50/60Hz
 L : 8,5 cm l : 8,5 cm H : 2,7 cm
 Matière : aluminium

Tension nominale	220-240V ~50/60Hz
Intensité max.	8.5A

Coloris	Ref.	CHF
● noir	210060	41.60
○ blanc	210061	41.60
● gris	210064	41.60

CÂBLE TEXTILE 3 pôles, 10 m



L : 1000 cm
 Ø : 0,6 cm
 Matière : polychlorure de vinyle (PVC) / textile

Tension max. 300V ACV

Coloris	Ref.	CHF
● noir	961270	64.00

CÂBLE 3 pôles, 3 x 0,75 mm², 10 m



L : 1000 cm

Tension max. 300V ACV

Coloris	Ref.	CHF
○ transparent	961250	33.00

FILIN DE SUSPENSION MÉTALLIQUE



L : 500 cm
 Ø : 0,15 cm
 Matière : acier / plastique

Tension max. 300V ACV

Coloris	Ref.	CHF
○ argent	961037	24.50



EMBOUS STOPPEURS POUR CÂBLE MÉTALLIQUE



IP 20

Ø : 0,7 cm
Matière : acier

CÂBLE D'EXTENSION



IP 20

L : 100 cm
Matière : plastique

- Avec fiche et raccord AMP

Intensité max. 0.35A

Coloris	Ref.	CHF
● gris	961034	33.00

Coloris	Ref.	CHF
○ blanc	111861	10.60

FICHE DE CONNEXION 3 sorties



IP 20

L : 5,2 cm l : 1,4 cm H : 1,3 cm
Matière : plastique

ADHÉSIF DOUBLE-FACE



L : 300 cm l : 0,9 cm

Intensité max. 0.35A

Coloris	Ref.	CHF
● noir	111850	17.00

Coloris	Ref.	CHF
○ transparent	220000	18.00



1000735 699

DOUILLE GU10 LED AVEC BOÎTE DE CONNEXION max. 10 W

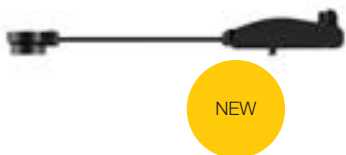

NEW



IP 20

L : 3,8 cm l : 3,1 cm H : 1,7 cm
Matière : plastique

DOUILLE GU10 AVEC BOÎTE DE CONNEXION universel



IP 20

220-240V ~50/60Hz
L : 2,8 cm l : 2,8 cm H : 3,7 cm
Matière : céramique / plastique

- Longueur de câble : 15 cm

DOUILLE GU10



IP 20

230V ~50Hz
H : 1,6 cm
Ø : 2,8 cm
Matière : céramique

- Longueur de câble : 15 cm

Tension nominale 230V ~50Hz

Coloris	Ref.	CHF
● noir	1007283	6.90

Coloris	Ref.	CHF
● blanc / noir	1000909	10.60

Coloris	Ref.	CHF
○ blanc	955135	3.10



BOÎTE DE CONNEXION IP68, 3 pôles



IP 68

230V ~50Hz
L : 11,5 cm
Ø : 2,7 cm
Matière : polyamide (PA)

Tension nominale	230V ~50Hz
Tension max.	450V ACV
Intensité max.	17.5A

Coloris	Ref.	CHF
● noir	228730	21.30

BOÎTE DE CONNEXION EN T IP68, 3 pôles



IP 68

230V ~50Hz
L : 11 cm l : 6,4 cm H : 3 cm
Matière : polyamide (PA)

Tension nominale	230V ~50Hz
Tension max.	500V DCV
Intensité max.	17.5A

Coloris	Ref.	CHF
● noir	228726	33.00

BOÎTE DE CONNEXION IP68, 5 pôles



IP 68

230V ~50Hz
L : 13 cm
Ø : 3,2 cm
Matière : polyamide (PA)

Tension nominale	230V ~50Hz
Tension max.	450V ACV
Intensité max.	32A

Coloris	Ref.	CHF
● noir	228725	21.30

BOÎTE DE CONNEXION IP68, 5 pôles, DALI



NEW





IP 68

450 V
L : 18 cm l : 6,3 cm H : 3,3 cm
Matière : polyamide 66 (PA 66)

Tension nominale	450V
Intensité max.	16A

Coloris	Ref.	CHF
● noir	1006453	41.90

NUMINOS®





	Encastrés	83 – 87, 91 – 93
	Appliques et plafonniers	99 – 101
	Plafonniers	103 – 105
	Suspensions	106 – 109
	Rails 3 allumages	110 – 113, 115
	Système 48 V	469 – 471
	Accessoires	94 – 95

Ou tout simplement configurer en ligne sur : numinos.slv.com

NEW TRIA®

	Encastrés	122 – 147
---	-----------------	-----------

MEDO®

	Appliques et plafonniers	148 – 161
	Plafonniers	164 – 165
	Suspensions	166 – 167
	Encastrés	168 – 169

LALU®

	Suspensions	176 – 183
---	-------------------	-----------

ONE®

	Suspensions	186 – 191
	Appliques et plafonniers	192 – 193
	Rails 3 allumages	194 – 195
	Lampes à poser et lampadaires	196 – 199

Remarque : les références à 7 chiffres se trouvent à partir de la page 886

111000		117351	262	143021	495
111262	238			143022	495
111292	239	132000		143030	497
111362	145	132020	409	143031	497
111382	145	132021	409	143032	497
111850	879	132024	409	143040	497
111861	879	132600	279, 281, 283, 295, 305, 309, 318	143041	497
		132601	279, 281, 283, 295, 305, 307, 309	143042	497
112000		132605	279, 281, 283, 295, 305, 309	143050	497
112221	227	132610	295, 305	143051	497
112222	227	132611	295, 305	143052	497
112225	227	132660	296	143060	497
112242	234	132661	296	143061	497
112682	227	132662	296	143062	497
112692	227	132670	878	143070	497
112720	238	132671	878	143071	497
112721	238	132680	878	143072	497
112780	238, 239, 240	132681	878	143080	497
112781	238, 239, 240	132690	295	143081	497
112910	220	132691	295	143082	497
112911	220	132835	660	143090	497
				143091	497
113000		133000		143092	497
113140	219	133009	309	143100	497
113141	219	133019	309	143101	497
113150	219	133050	309	143102	497
113151	219	133060	309	143110	497
113160	220	133444	307	143111	497
113161	220	133481	314	143112	497
113170	221	133482	314	143120	279
113171	221	133489	314	143121	279
113262	238	133490	314	143124	279
113292	239	133840	167	143130	497
113492	145	133841	167	143131	497
113512	145	133850	167	143132	497
113540	145	133851	167	143151	497
113541	145			143152	497
113550	145	135000		143160	497
113830	145	135250	153, 157, 161, 165	143161	497
113840	145	135251	153, 157, 161, 165	143162	497
113841	145	135254	153, 157, 161, 165	143169	497
113890	141			143170	497, 499
113891	141	138000		143171	497, 499
113930	257	138981	868	143172	497, 499
113931	257	138982	868	143190	513
113940	257	138991	868	143191	513
113941	257	138992	868	143221	499
113970	141			143230	499
113971	141	139000		143231	499
113976	141	139004	483	143241	499
		139006	484	143251	499
114000		139024	482	143261	499
114420	245	139026	483	143271	499
114421	245	139030	482	143281	499
114426	245	139031	482	143350	521
114430	245	139040	483	143351	521
114431	245	139041	483	143354	521
114436	245	139050	483	143380	497
114440	246	139051	483	143381	497
114441	246	139060	484	143382	497
114450	247	139061	484	143390	513
114451	247	139070	486	143391	513
114480	232	139071	486	143392	513
114481	232	139072	486	143430	519
		139080	486	143431	519
115000		139081	486	143432	519
115510	214	139082	486	143440	519
115511	214	139090	487	143441	519
115520	214	139091	487	143442	519
115521	214	139092	487	143450	515
115530	214	139100	489	143451	515
115531	214	139101	489	143454	515
115540	215	139102	489	143540	520
115541	215	139120	491	143541	520
115550	215	139121	491	143544	520
115551	215	139122	491	143580	507
		139130	489	143581	507
117000		139131	489	143594	511
117100	265	139132	489	143621	511
117101	265			143731	520
117110	265	143000		143811	521
117111	265	143010	495	143930	512
117311	230	143011	495	143932	512
117321	262	143012	495	143941	516
117331	230	143020	495	143951	517

143960	517	151456	367	155530	312
143961	517	151511	263	155540	447
143990	509	151514	263	155550	266
143991	509	151531	263, 408	155551	266
144000		151534	263, 408	155582	267, 297, 449
144010	511	151591	373	155583	267, 297, 449
144011	511	151710	368	155592	267, 297, 449
144019	511	151711	368	155714	306
144200	515	151740	368	155752	375
144201	515	151741	368	155780	447
144204	515	151781	329	155790	447
		151786	329	155910	313
		151791	329	155930	313
		151796	329		
145000		151800	379	156000	
145990	279, 281, 283, 295, 305, 309	151801	379	156050	268
145994	279, 281, 283, 295, 305, 309	151803	379	156051	268
146000		151810	259	156100	297
146010	453	151811	259	156111	267, 297, 449
146332	389	151830	407	156113	267, 297, 449
146682	387	151831	407	156122	267, 297, 449
146692	387	151840	259, 379, 407	156141	296, 448
		151850	305	156143	296, 448
147000		151851	305	156152	296, 448
147301	405	151853	305		
147306	405	151950	242	158000	
147311	405	151952	242	158400	301
147316	405	151960	242	158410	303
147321	405	151962	242	158799	243
147326	405				
147360	411	152000		161000	
147361	411	152010	407	161271	231
147370	411	152011	407	161291	231
147371	411	152020	407	161461	272
147380	411	152021	407		
147381	411	152101	259	165000	
147441	415	152230	541	165358	319
147442	415	152231	541	165359	319
147443	415	152232	541	165390	317
147444	415	152240	541	165400	317
147529	373	152241	541	165410	317
147550	409	152242	541		
147551	409	152320	538	181000	
147559	409	152321	538	181530	485
		152330	399	181531	485
		152331	399	181532	485
148000		152340	383		
148001	271	152341	383	186000	
148002	271	152360	301	186300	485
148004	270	152370	303	186301	485
148005	271	152380	232	186302	485
148010	357	152381	232	186310	485
148012	361	152430	543	186311	485
148013	361	152431	543	186312	485
148016	361	152600	540	186330	485
148018	356	152601	540	186331	485
148019	359	152610	540	186332	485
148060	360	152611	540	186340	485
148070	233	152640	543	186341	485
148071	233	152641	543	186342	485
148091	359	152750	537	186350	485
148540	388	152751	537	186351	485
		152780	537	186352	485
149000		152781	537	186360	485
149381	305	152960	543	186361	485
149387	305	152961	543	186362	485
149388	305			186640	485
149452	381	153000		186641	485
149471	334	153130	536	186642	485
149511	334	153140	535		
149762	332	153141	535	210000	
149772	332	153420	537	210060	318, 878
		153421	537	210061	878
151000		153421	537	210064	878
151040	314	153560	539		
151041	314	153561	539	220000	
151049	314	153564	539	220000	879
151271	366	153850	537		
151275	366	153851	537	227000	
151282	337			227176	779
151320	362	155000		227195	768
151321	362	155156	273	227219	657
151410	367	155180	427	227220	657
151411	367	155236	427	227221	657
151450	367	155373	269	227210	694
151451	367	155490	448		

227418	694	229961	812	232195	676, 677
227462	848	229965	812	232285	781
227505	689	229971	813	232294	682
227600	854	229975	813	232295	682
227604	854			232431	755
227680	857	230000		232435	752
227684	857	230030	759	232441	753
227922	667, 668	230034	759	232445	753
		230044	746	232461	752
228000		230045	746	232465	752
228100	667	230060	631, 661, 671, 685	232485	773
228110	667	230061	671	232491	773
228130	667	230063	671	232495	773
228332	849	230066	671	232497	773
228342	849	230069	671	232531	741
228412	839	230084	747	232535	741
228430	845	230085	747	232537	741
228434	845	230090	642	232905	771
228555	699	230355	779	232915	771
228560	699	230365	765		
228712	653, 665, 685	230435	660	233000	
228722	653, 665	230444	746	233094	811
228725	881	230445	746	233095	811
228730	881	230465	659	233104	785
228752	685	230655	747	233105	785
228753	613, 659	230657	747	233114	764
228754	633, 637			233115	764
228771	761	231000		233134	783
228775	761	231010	758	233135	783
228776	761	231012	758	233145	685
228925	665	231015	758	233165	685
228935	665	231035	696	233185	685
228945	665	231072	693	233214	764, 783, 785
228960	663	231205	743	233215	764, 783, 785
228965	663	231215	637	233245	809
		231225	637	233255	809
229000		231230	633, 637, 640, 641	233302	761
229020	646	231231	681	233427	642
229021	646	231233	648, 649, 655, 669, 673	233437	643
229022	646, 647	231235	649	233447	640
229062	827	231305	681	233457	640
229071	815	231315	780	233500	840
229072	815	231351	762	233520	840
229075	815	231355	762	233540	847
229081	815	231370	649	233570	698
229085	815	231371	649	233571	698
229090	697	231410	647	233580	698
229110	825	231411	647	233582	698
229162	668	231420	648	233601	823
229172	668	231440	649	233605	823
229200	847	231455	675	233615	823
229230	846	231457	675	233621	823
229234	847	231475	672	233625	823
229320	843	231505	685	233635	822
229324	843	231515	808	233639	822
229374	843	231525	703	233650	825
229381	839	231535	703	233660	825
229383	839	231541	801	233792	849
229410	641	231545	801		
229411	641	231585	778	234000	
229420	643	231595	672	234505	736
229421	643	231805	768	234515	735
229422	642, 643, 645, 662	231807	768	234525	737
229430	645	231815	675	234535	797
229431	645	231817	675		
229432	645	231960	692	461000	
229524	736	231961	692	461060	868
229525	736			464804	873
229531	735	232000			
229532	735	232045	777	631000	
229535	735	232055	799	631337	433
229551	797	232065	659	631339	433
229554	797	232075	659		
229555	797	232085	659	900000	
229564	737	232101	775	900011	697, 698
229565	737	232105	775		
229574	735	232115	633	955000	
229575	735	232119	633	955135	880
229664	775	232125	633		
229665	775	232135	678	961000	
229702	827	232145	678	961034	879
229740	695	232155	676	961037	878
229741	697	232165	676	961250	878
229931	817	232175	677	961270	878
229935	817	232185	677		

1000100	
1000127	403
1000128	403
1000129	403
1000130	403
1000131	403
1000132	403
1000135	403
1000136	403

1000300	
1000327	377
1000329	377
1000330	377
1000332	801
1000333	767
1000334	767
1000335	781
1000336	779
1000339	801
1000340	767
1000342	767
1000343	673
1000344	673
1000345	673
1000346	673
1000384	849
1000398	659, 661

1000400	
1000422	365
1000423	365
1000458	567
1000459	567
1000461	567
1000462	567
1000464	567
1000465	567
1000466	569, 571
1000468	569, 571
1000469	569, 571
1000473	569
1000474	569
1000476	569
1000477	569
1000479	569
1000480	569
1000487	569
1000489	569
1000497	573
1000498	573

1000500	
1000523	573
1000524	573
1000525	573
1000533	573
1000534	573
1000535	575
1000536	575
1000540	574
1000546	574
1000549	574
1000557	575
1000558	575
1000560	574
1000561	574
1000566	574
1000567	574
1000571	574
1000574	239
1000575	239
1000576	238
1000577	238
1000579	267, 297, 449
1000580	267, 297, 449

1000600	
1000613	351
1000614	353
1000615	353
1000616	351
1000618	351
1000621	353
1000623	353

1000634	367
1000638	362
1000639	362
1000640	362
1000655	849
1000665	662
1000666	662
1000668	341
1000669	341
1000670	341
1000682	666
1000683	666
1000685	253
1000686	253
1000688	253
1000689	253
1000691	253
1000692	253
1000694	253
1000695	253

1000700	
1000702	405
1000703	405
1000704	405
1000711	516
1000712	517
1000713	511
1000714	228
1000715	228
1000716	228
1000717	228
1000718	228
1000719	228
1000720	228
1000721	228
1000726	165
1000729	379
1000730	379
1000735	699
1000736	699
1000763	448
1000773	296
1000777	339
1000780	339
1000783	274
1000784	274
1000785	274
1000786	274
1000797	780
1000799	684

1000800	
1000801	684
1000807	261
1000808	261
1000809	261, 306
1000810	261, 306
1000811	261, 306
1000812	261, 306
1000813	306
1000820	777
1000821	661
1000822	661
1000823	799
1000824	351
1000825	353
1000833	237
1000880	783
1000881	783
1000886	413
1000887	413
1000889	413
1000890	413
1000892	413
1000893	413
1000895	413
1000896	413

1000900	
1000909	880
1000910	377
1000911	377
1000914	218
1000915	218

1000917	218
1000926	293
1000927	293
1000929	293
1000930	293
1000932	293
1000933	293
1000935	293
1000936	293
1000957	297

1001000	
1001015	236
1001016	236
1001017	237
1001018	237
1001019	430
1001020	430

1001100	
1001165	235
1001166	235
1001167	235
1001168	235
1001169	235
1001171	235
1001172	235

1001200	
1001254	853
1001255	853
1001256	853
1001262	853
1001263	853
1001264	237
1001272	380
1001273	380
1001274	380
1001275	380
1001276	380
1001283	431
1001284	431
1001286	431
1001287	431
1001299	341

1001300	
1001300	341
1001303	341
1001304	341
1001309	293
1001310	293
1001314	817
1001359	853

1001400	
1001400	291
1001403	291
1001406	291
1001409	291
1001460	452
1001461	452
1001462	452
1001463	452
1001468	388
1001472	388
1001488	669
1001489	669
1001490	669
1001494	669

1001500	
1001505	275
1001506	275
1001508	275
1001509	275
1001542	279, 281, 283, 295, 305, 307
1001574	861
1001575	861

1001700	
1001701	312
1001800	
1001861	521
1001868	513

1001869	513	1002203	701	1002890	167
1001871	539	1002215	263, 408	1002891	167
1001872	539	1002216	263	1002893	841
1001900		1002218	868	1002895	841
1001901	170	1002221	869	1002897	841
1001902	170	1002228	335	1002898	841
1001903	170	1002229	335	1002899	841
1001905	171	1002238	357		
1001906	171	1002239	371	1002900	
1001907	171	1002240	371	1002900	721
1001930	234	1002400		1002902	721
1001931	234	1002402	745	1002903	807
1001939	272	1002403	745	1002904	807
1001950	153, 157, 161, 165	1002423	875	1002905	783
1001951	153, 157, 161, 165	1002424	875	1002906	631
1001952	153, 157, 161, 165	1002425	875	1002907	631
1001962	697	1002430	387	1002909	188
1001963	697	1002431	387	1002910	188
1001964	694	1002432	387	1002911	188
1001965	694	1002432	387	1002912	188
1001968	509	1002494	663	1002913	189
1001969	762	1002500		1002914	189
1001970	762	1002503	763	1002915	193
1001999	655	1002504	763	1002917	193
		1002505	763	1002918	193
1002000		1002505	763	1002919	193
1002000	655	1002583	453, 601	1002922	243
1002001	655	1002591	221	1002925	373
1002002	777	1002592	221	1002927	373
1002003	257	1002594	221	1002928	363
1002004	255	1002600		1002929	363
1002005	255	1002602	482	1002931	379
1002006	255	1002603	482	1002933	379
1002008	257	1002604	482	1002934	261
1002010	255	1002607	387	1002936	261
1002011	255	1002608	387	1002937	305
1002012	255	1002608	387	1002939	305
1002013	255	1002686	535	1002940	426
1002015	255	1002690	491	1002941	426
1002018	765	1002691	868	1002948	311
1002020	423	1002692	868	1002949	311
1002021	423	1002693	868	1002950	311
1002022	423	1002694	491	1002951	310
1002023	405	1002695	491	1002952	760
1002024	405	1002696	491	1002953	760
1002025	405	1002697	485	1002954	760
1002029	411	1002698	485	1002955	760
1002030	411	1002699	485	1002956	679
1002032	739	1002700		1002957	679
1002033	739	1002700	485	1002958	679
1002034	739	1002701	485	1002959	679
1002035	773	1002702	485	1002962	329
1002045	315	1002702	485	1002964	329
1002046	315	1002703	485	1002965	261
1002069	759	1002704	485	1002967	272
1002070	759	1002705	485	1002968	272
1002075	425	1002791	872	1002969	401
1002076	425	1002800		1002970	401
1002077	425	1002842	363	1002971	401
1002098	244	1002843	363	1002973	401
1002099	244	1002844	363	1002974	401
		1002844	363	1002975	401
1002100		1002845	497	1002976	401
1002100	244	1002853	723, 725, 727, 729, 730, 777	1002977	401
1002101	244	1002854	520	1002978	401
1002102	244	1002855	381	1002979	241
1002110	517	1002860	389	1002980	241
1002111	517	1002861	489	1002981	241
1002113	517	1002862	489	1002982	243
1002116	387	1002863	489	1002989	770
1002117	387	1002864	490	1002990	770
1002118	387	1002865	490	1002991	681
1002119	387	1002866	490	1002992	681
1002140	383	1002867	785		
1002151	495	1002868	769	1003000	
1002152	495	1002869	769	1003001	683
1002153	495	1002871	652	1003004	281
1002163	279, 281, 283, 295	1002873	509	1003005	281
1002190	333	1002874	509	1003006	281
1002191	333	1002875	509	1003007	281
1002192	333	1002876	535	1003008	223
		1002877	535	1003009	223
1002200		1002878	535	1003010	223
1002201	701	1002882	165	1003011	225
		1002884	785	1003012	225

1003013	225	1003508	339	1004737	591
1003014	419	1003518	811	1004738	376
1003015	419	1003519	811	1004739	376
1003016	419	1003530	290	1004740	370
1003017	417	1003532	290	1004741	370
1003018	417	1003535	651	1004742	370
1003019	417	1003536	650	1004743	370
1003029	448	1003537	651	1004744	281, 295, 309, 318
1003040	275	1003538	651	1004745	281, 295, 309
1003041	275	1003539	775	1004746	281, 295, 309
1003042	275			1004747	749
1003043	275	1004600		1004748	749
1003044	289	1004649	785	1004749	629
1003045	289	1004650	756	1004750	629
1003046	289	1004651	756	1004751	629
1003047	289	1004652	701	1004757	693
1003048	289	1004653	808	1004759	188
1003049	289	1004660	349	1004760	188
1003050	289	1004661	349	1004761	188
1003051	289	1004662	349	1004762	188
1003052	275	1004663	349	1004763	188
1003053	275	1004664	399	1004764	188
1003054	275	1004665	399	1004765	189
1003055	275	1004666	258	1004766	189
1003073	243	1004667	258	1004767	189
1003074	243	1004668	229	1004768	189
		1004669	229	1004769	194
1003100		1004670	355	1004770	194
1003104	870	1004671	355	1004771	194
1003105	871	1004674	295, 309	1004772	194
1003106	869	1004675	295, 309	1004773	296, 448
		1004676	295	1004774	267, 297, 449
1003300		1004677	797	1004775	267, 297, 449
1003316	369	1004678	757	1004780	875
1003317	369	1004679	757	1004781	876
		1004680	653	1004782	877
1003400		1004681	653	1004783	497
1003416	729	1004682	376	1004784	497
1003417	729	1004686	533	1004785	497
1003418	730	1004687	533		
1003419	730	1004688	533	1004800	
1003420	795	1004689	533	1004889	570
1003421	795	1004690	533	1004890	570
1003422	725	1004691	533	1004893	571
1003423	725	1004692	533	1004894	571
1003424	727	1004693	533	1004895	571
1003425	727	1004694	223	1004896	577
1003426	793	1004695	223	1004897	577
1003427	793	1004696	223	1004898	577
1003428	375	1004697	225	1004899	577
1003429	375	1004698	225		
1003430	375	1004699	225	1004900	
1003431	375			1004900	578
1003432	307	1004700		1004901	578
1003435	300	1004700	419	1004902	578
1003436	300	1004701	419	1004903	579
1003437	729	1004702	419	1004904	579
1003438	730	1004705	417	1004905	577
1003439	795	1004706	382	1004906	577
1003440	725	1004707	382	1004907	577
1003441	727	1004708	582	1004908	577
1003442	793	1004709	582	1004909	578
1003447	692	1004710	582	1004910	578
1003448	692	1004712	583	1004911	579
1003449	813	1004713	583	1004912	578
1003450	813	1004714	583	1004913	578
1003451	813	1004716	584	1004914	578
1003452	813	1004717	584	1004915	578
1003453	759	1004718	584	1004916	578
1003454	759	1004719	584	1004917	578
1003455	384	1004720	585	1004932	575
1003456	385	1004721	585	1004933	507
1003457	384	1004722	586	1004934	507
1003458	385	1004723	586	1004935	507
1003459	385	1004725	587	1004936	507
1003460	385	1004726	591	1004957	785
1003466	240	1004727	589	1004969	349
1003467	364	1004729	330	1004970	453
1003468	364	1004730	330	1004971	337
1003470	721	1004731	331		
1003479	792, 793, 795	1004732	359	1005000	
		1004733	356	1005075	862
1003500		1004734	591	1005076	862
1003506	339	1004735	591	1005077	862
1003507	339	1004736	591	1005078	862

1005079	862	1005315	862	1006195	874
1005080	862	1005316	862	1006196	874
1005081	862	1005317	864	1006197	874
1005082	862	1005318	864	1006198	875
1005083	862	1005381	869	1006199	874
1005085	420	1005387	873		
1005086	420	1005390	445	1006200	
1005087	421	1005391	445	1006202	873
1005088	421	1005392	445	1006268	719
1005089	814	1005394	445	1006270	719
1005090	814	1005395	288		
		1005396	288	1006300	
1005100		1005397	532	1006307	355
1005125	755	1005399	532	1006308	355
1005126	755			1006314	749
1005148	739	1005400		1006316	791
1005149	739	1005400	532	1006317	720
1005150	739	1005401	532	1006318	720
1005151	741	1005402	532	1006319	349, 720
1005153	741	1005407	217	1006321	861
1005154	741	1005408	217	1006326	691
1005155	741	1005410	217	1006327	792
1005156	741	1005415	217	1006328	723
1005157	741	1005416	217	1006329	723
1005177	188	1005418	217	1006336	870
1005178	189	1005423	217	1006343	445
		1005424	217	1006344	445
1005200		1005435	220	1006345	288
1005201	744	1005436	220	1006348	869
1005202	811	1005439	630	1006377	295
1005205	725, 727, 729, 730, 731, 793	1005440	630	1006378	295
1005206	725, 727, 729, 730, 731, 793	1005441	683	1006379	614, 615, 616, 617, 618, 619
1005207	725, 727, 729, 730, 731, 793	1005442	639	1006380	614, 615, 616, 617, 618, 619
1005214	318	1005443	751	1006381	614, 615, 616, 617, 618, 619
1005215	318	1005444	869	1006382	614, 615, 616, 617, 618, 619
1005216	318	1005445	869	1006383	616
1005217	318	1005446	171, 873	1006384	619
1005218	318			1006385	618
1005248	876	1006100		1006386	621
1005262	725, 727, 729, 730, 731	1006104	855	1006387	617
1005263	725, 727, 729, 730, 731	1006105	855	1006388	620
1005265	865	1006106	839	1006389	617
1005268	865	1006107	839	1006390	619
1005269	860	1006120	877	1006391	618
1005271	860	1006121	219	1006392	621
1005272	860	1006122	219	1006393	617
1005273	861	1006123	429	1006394	620
1005274	863	1006124	429	1006395	281
1005275	863	1006125	429	1006396	281
1005276	863	1006126	429	1006397	281
1005277	863	1006127	429	1006398	281
1005278	863	1006128	429	1006399	281
1005279	863	1006133	871		
1005280	863	1006134	872	1006400	
1005281	863	1006155	508	1006400	281
1005282	863	1006156	508	1006402	281
1005283	863	1006157	534	1006403	281
1005284	860	1006158	534	1006404	717
1005285	860	1006159	309, 508, 534	1006405	717
1005286	860	1006160	309, 508, 534	1006406	821
1005287	860	1006161	382	1006407	821
1005288	860	1006162	382	1006408	627
1005289	865	1006171	851	1006409	627
1005290	865	1006172	851	1006410	318
1005291	863	1006173	851	1006411	157
1005292	863	1006174	851	1006412	157
1005294	864	1006175	851	1006414	157
1005295	864	1006176	851	1006415	157
1005296	864	1006178	742	1006417	157
1005297	862	1006179	742	1006418	157
1005298	862	1006180	635	1006420	157
1005299	862	1006181	635	1006421	157
		1006182	635	1006423	395
1005300		1006183	743	1006424	395
1005301	864	1006184	637	1006425	397
1005302	864	1006185	191	1006426	397
1005303	864	1006186	191	1006427	397
1005305	865	1006187	191	1006428	397
1005307	865	1006188	191	1006429	397
1005308	865	1006189	191	1006430	397
1005310	865	1006190	191	1006431	285
1005311	861	1006191	691	1006432	285
1005312	861	1006192	691	1006433	285
1005313	863	1006193	691	1006434	285
1005314	863	1006194	874	1006435	285

1006436	285	1006633	475	1007250	870
1006437	285	1006634	475	1007251	870
1006438	285	1006635	475	1007252	870
1006439	397	1006636	475	1007253	870
1006440	397	1006639	477	1007254	871
1006441	347	1006640	477	1007255	871
1006442	347	1006641	477	1007256	871
1006443	347	1006642	477	1007257	871
1006444	347	1006645	477	1007270	876
1006445	505	1006646	477	1007271	208
1006446	505	1006647	477	1007272	208
1006449	285, 347, 395, 505	1006648	477	1007273	209
1006450	285, 347, 395, 505			1007274	209
1006451	285, 347, 395, 505	1007000		1007281	711
1006452	868	1007083	459, 463, 467	1007282	711
1006453	881	1007084	459, 463, 467	1007283	880
1006454	243, 874	1007090	207	1007284	150
1006455	875	1007091	207	1007285	150
1006456	873	1007092	207	1007286	152
		1007093	207	1007287	152
1006500		1007094	207	1007288	150
1006565	459, 463, 467	1007095	205	1007289	150
1006566	459, 463, 467	1007096	205	1007290	152
1006567	459, 463, 467	1007097	205	1007291	152
1006568	459, 463, 467	1007098	205	1007292	150
1006569	459, 463, 467	1007099	205	1007293	150
1006570	459, 463, 467			1007294	152
1006571	459, 463, 467	1007100		1007295	152
1006572	459, 463, 467	1007137	459, 463, 467	1007296	150
1006573	459, 463, 467	1007138	459, 463, 467	1007297	150
1006574	459, 463, 467	1007142	715	1007298	152
1006575	459	1007143	715	1007299	152
1006576	459	1007144	715		
1006577	459	1007145	715	1007300	
1006578	459	1007146	689	1007300	151
1006579	459	1007147	689	1007301	151
1006580	459	1007180	205	1007302	153
1006581	463	1007181	205	1007303	153
1006582	463	1007182	205	1007304	151
1006583	463	1007183	205	1007305	151
1006584	463	1007184	207	1007306	153
1006585	463	1007185	207	1007307	153
1006586	463	1007186	207	1007308	151
1006587	467	1007187	207	1007309	151
1006588	467	1007188	463, 467	1007310	153
1006589	467	1007189	463, 467	1007311	153
1006590	467	1007190	285, 347, 395, 505	1007312	151
1006591	467	1007191	207	1007313	151
1006592	467	1007192	205	1007314	153
1006593	459	1007193	205	1007315	153
1006594	459	1007194	207	1007316	161
1006595	463	1007195	831	1007317	161
1006596	463	1007196	831	1007318	161
1006597	467	1007197	831	1007319	161
1006598	467	1007198	831	1007320	161
1006599	459, 463, 467			1007321	161
		1007200		1007322	161
1006600		1007200	331	1007323	161
1006600	459, 463, 467	1007201	331	1007324	161
1006601	459, 463, 467	1007202	331	1007325	161
1006602	459, 463, 467	1007207	744	1007326	161
1006603	459, 463, 467	1007213	872	1007327	161
1006604	459, 463, 467	1007215	872	1007328	126
1006605	459, 463, 467	1007216	876	1007329	126
1006606	459, 463, 467	1007225	876	1007330	126
1006607	459, 463, 467	1007226	872	1007331	126
1006608	459, 463, 467	1007228	872	1007332	126
1006609	459, 463	1007229	873	1007333	126
1006610	467	1007230	861	1007334	126
1006611	459	1007231	861	1007335	126
1006612	459	1007232	614	1007336	126
1006613	459, 463, 467	1007233	614	1007337	126
1006614	459, 463, 467	1007234	615	1007338	126
1006615	473	1007235	615	1007339	126
1006616	473	1007236	714	1007340	126
1006617	473	1007237	613	1007341	126
1006618	473	1007238	835, 837	1007342	126
1006621	475	1007239	835, 837	1007343	126
1006622	475	1007240	835, 837	1007344	126
1006623	475	1007241	837	1007345	126
1006624	475	1007242	837	1007346	126
1006627	473	1007243	835	1007347	126
1006628	473	1007244	835	1007348	126
1006629	473	1007245	835	1007349	126
1006630	473	1007246	837	1007350	126

1007351	126	1007443	126	1007597	279, 505, 531
1007352	503	1007444	126	1007598	279
1007353	503	1007445	126	1007599	279
1007354	503	1007446	126		
1007355	529	1007447	126	1007600	
1007356	529	1007448	126	1007600	327
1007357	437, 597	1007449	126	1007601	327
1007358	437, 597	1007450	126	1007602	327
1007359	437, 597	1007451	126	1007603	327
1007360	437, 597	1007452	126	1007604	251
1007361	437, 597	1007453	126	1007605	251
1007362	437, 597	1007454	126	1007606	251
1007363	443	1007458	805	1007607	251
1007364	443	1007459	607	1007608	395
1007365	443	1007460	607	1007609	395
1007366	443	1007461	791	1007610	395
1007368	138	1007462	444	1007611	395
1007369	138	1007463	444	1007612	325
1007370	138	1007464	444	1007613	325
1007371	138	1007465	444	1007614	325
1007372	138	1007466	444	1007615	325
1007373	138	1007467	444	1007616	325
1007374	138	1007468	287	1007617	325
1007375	138	1007469	287	1007618	325
1007376	138	1007470	287	1007619	325
1007377	138	1007471	287	1007620	443
1007378	138	1007472	287	1007621	443
1007379	138	1007473	287	1007622	443
1007380	441, 601	1007488	126	1007623	443
1007381	124	1007489	126	1007624	139
1007382	124			1007625	139
1007383	124	1007500		1007626	139
1007384	124	1007511	805	1007627	139
1007385	134	1007512	609	1007628	139
1007386	134	1007513	609	1007629	139
1007387	134	1007521	178	1007630	126
1007388	134	1007522	178	1007631	126
1007389	134	1007523	178	1007632	126
1007390	134	1007524	178	1007633	126
1007391	134	1007525	178	1007634	126
1007392	134	1007526	178	1007635	126
1007393	134	1007527	178	1007636	126
1007394	134	1007528	178	1007637	126
1007395	134	1007529	178	1007638	501
1007396	134	1007530	178	1007639	501
1007397	134	1007531	178	1007640	501
1007398	134	1007532	178	1007641	503
1007399	134	1007533	178	1007642	503
		1007534	178	1007643	503
1007400		1007535	178	1007644	527
1007400	134	1007536	178	1007645	527
1007401	137	1007537	178	1007646	527
1007402	137	1007538	178	1007647	527
1007403	137	1007539	178	1007648	529
1007404	137	1007540	178	1007649	529
1007405	135	1007541	178	1007651	603
1007406	135	1007542	178	1007652	603
1007407	135	1007543	178	1007653	805
1007408	135	1007544	178	1007654	525
1007409	125	1007545	178	1007655	525
1007410	125	1007546	178	1007656	525
1007411	125	1007547	178	1007657	525
1007412	125	1007551	213	1007667	713
1007421	124	1007552	213	1007668	713
1007422	124	1007559	213	1007669	611
1007423	135	1007560	213	1007670	611
1007424	135	1007567	213	1007673	501
1007425	135	1007568	213	1007674	501
1007426	135	1007580	605	1007680	833
1007427	135	1007581	709	1007681	833
1007428	135	1007582	789	1007682	833
1007429	135	1007583	605	1007683	833
1007430	135	1007584	605	1007684	833
1007431	125	1007585	709	1007685	833
1007432	125	1007586	789	1007692	439, 599
1007433	136	1007587	605	1007693	439, 599
1007434	136	1007588	279	1007694	439, 599
1007435	136	1007589	279	1007695	439, 599
1007436	136	1007590	393	1007696	439, 599
1007437	136	1007591	393	1007697	439, 599
1007438	136	1007592	393		
1007439	137	1007593	393		
1007440	137	1007594	345		
1007441	137	1007595	345		
1007442	137	1007596	279, 505, 531		

SIGHT MOVE
1004690



1 ALLUMAGE

RAIL 1 ALLUMAGE EN SAILLIE	495
RAIL 1 ALLUMAGE EN SAILLIE ACCESSOIRES	497
RAIL 1 ALLUMAGE ENCASTRÉ	499
RAIL 1 ALLUMAGE ENCASTRÉ ACCESSOIRES	499

3 ALLUMAGES

RAIL 3 ALLUMAGES EUTRAC® EN SAILLIE	537
RAIL 3 ALLUMAGES EUTRAC® EN SAILLIE ACCESSOIRES	539
RAIL 3 ALLUMAGES EUTRAC® ENCASTRÉ	541
RAIL 3 ALLUMAGES EUTRAC® ENCASTRÉ ACCESSOIRES	541
RAIL 3 ALLUMAGES S-TRACK EN SAILLIE DALI	529
RAIL 3 ALLUMAGES S-TRACK EN SAILLIE DALI ACCESSOIRES	530-531
RAIL 3 ALLUMAGES S-TRACK ENCASTRÉ DALI	533
RAIL 3 ALLUMAGES S-TRACK ENCASTRÉ DALI ACCESSOIRES	535

SYSTÈMES 48 V

RAIL 48 V TRACK EN SAILLIE DALI	457
RAIL 48 V TRACK EN SAILLIE DALI ACCESSOIRES	459
RAIL 48 V TRACK EN SAILLIE PROFOND DALI	461
RAIL 48 V TRACK EN SAILLIE PROFOND DALI ACCESSOIRES	463
RAIL 48 V TRACK ENCASTRÉ DALI	465
RAIL 48 V TRACK ENCASTRÉ DALI ACCESSOIRES	467

A

ABRIDOR 100 BORNE	681
ABRIDOR 60 BORNE	681
ABRIDOR SENSOR WL	770
ABRIDOR WL	770

ACCESSOIRES

ADHÉSIF DOUBLE-FACE	879
ALIMENTATION LED 100W 24V 2 CANAUX, VARIABLE DALI	872
ALIMENTATION LED 100W 24V DC	871
ALIMENTATION LED 15W 12V	869
ALIMENTATION LED 15W 24V	869
ALIMENTATION LED 20W 12/24V	869
ALIMENTATION LED 25W 24V	870
ALIMENTATION LED 50W 24V	870
ALIMENTATION LED 60W DALI, 24V, 2 CANAUX, VARIABLE DALI	871
BOÎTE DE CONNEXION EN T IP68, 3 PÔLES	881
BOÎTE DE CONNEXION IP68, 3 PÔLES	881
BOÎTE DE CONNEXION IP68, 5 PÔLES	881
CÂBLE D'EXTENSION	879
CÂBLE TEXTILE 3 PÔLES, 10 M	878
CONNECTION BOX IP68, 5 PÔLES, DALI	881
CONTROLLER LED STIP CCT / RGBW	869
CONVERTISSEUR PHASE DIM -> DALI	868
CROCHET DE PLAFOND	878
DALI CONTROLLER 24V DC	869
DALI INTERFACE 1-10V + ON/OFF	868
DALI UNIVERSAL DIMMER 10-300W	869
DOUILLE GU10	880
DOUILLE GU10 AVEC BOÎTE DE CONNEXION, UNIVERSEL	880
DOUILLE GU10 LED AVEC BOÎTE DE CONNEXION, MAX. 10W	880
DRIVER LED 10W 200 MA VARIABLE, AVEC SERRE-CÂBLE	872
DRIVER LED 100W 24V DC AVEC SERRE-CÂBLE	870
DRIVER LED 100W 24V DC, VARIABLE DALI, AVEC SERRE-CÂBLE	871
DRIVER LED 10W 250MA	875
DRIVER LED 12W 250 MA DALI VARIABLE AVEC INTERFACE RF	874
DRIVER LED 150W 24V DC AVEC SERRE-CÂBLE	870
DRIVER LED 150W 24V DC, VARIABLE DALI, AVEC SERRE-CÂBLE	871

DRIVER LED 20W 250-700 MA VARIABLE 1-10V/DALI	875
DRIVER LED 20W 700 MA VARIABLE	873
DRIVER LED 20W 350MA DIMMBAR	872
DRIVER LED 20W 350MA	876
DRIVER LED 20W 350MA/500MA PHASE	872
DRIVER LED 21W 500 MA, AVEC SERRE-CÂBLE	876
DRIVER LED 25W 150-300 MA VARIABLE DALI	873
DRIVER LED 25W 150-700 MA VARIABLE DALI	873
DRIVER LED 250W 24V DC AVEC SERRE-CÂBLE	870
DRIVER LED 250W 24V DC, VARIABLE DALI AVEC SERRE-CÂBLE	871
DRIVER LED 3W 350 MA, AVEC FICHE AMP	876
DRIVER LED 3W 700 MA AVEC SERRE-CÂBLE	876
DRIVER LED 30W 24V DC AVEC SERRE-CÂBLE	870
DRIVER LED 30W 24V DC, VARIABLE DALI, AVEC SERRE-CÂBLE	871
DRIVER LED 30W 700MA	876
DRIVER LED 3W 350MA	876
DRIVER LED 40W 1000 MA VARIABLE	873
DRIVER LED 40W 1050 MA VARIABLE	873
DRIVER LED 40W 1050 MA DALI VARIABLE AVEC INTERFACE RF	874
DRIVER LED 40W 500-1050 MA VARIABLE 1-10 V/DALI	875
DRIVER LED 40W 700 MA VARIABLE	873
DRIVER LED 40W 700 MA DALI VARIABLE AVEC INTERFACE RF	874
DRIVER LED 40W 1050MA	877
DRIVER LED 40W 1050MA DALI CCT TUNABLE	875
DRIVER LED 40W 700/900/1000MA	877
DRIVER LED 50W 700-1500 MA VARIABLE 1-10V/DALI	875
DRIVER LED 6W 350 MA VARIABLE	872
DRIVER LED 700MA PHASE	872
DRIVER LED, 40W 500 MA DALI VARIABLE AVEC INTERFACE RF	874
EMBOUTS STOPPEURS POUR CÂBLE MÉTALLIQUE	879
FICHE DE CONNEXION 3 SORTIES	879
FILIN DE SUSPENSION MÉTALLIQUE	878
GLENOS® PATÈRE	878
MODULE RF POUR DRIVER DALI	874, 875
SERRE-CÂBLE	878
TRANSFORMATEUR 60VA 12V AC	868
TRANSFORMATEUR TENSEO 12V AC 105 VA ONVENTIONNEL	868
TRANSFORMATEUR TENSEO 12V AC 210 VA CONVENTIONNEL	868
TRANSFORMATEUR TENSEO 12V AC 50 VA CONVENTIONNEL	868
ADEGAN FL, E27	663
ADEGAN MANILA FL, E27	663
ADI EL	822
AINOS CW	812
AINOS CW SENSOR	813
AINOS CW SENSOR, CARRÉ	813
AINOS CW, CARRÉ	813
AKALO D83 EL	237
ALPA CONE 100 BORNE, E27	665
ALPA MUSHROOM 45 BORNE, E27	665
ALPA MUSHROOM 75 BORNE, E27	665
ALTRA DICE CL, QPAR51	263
ALTRA DICE CW, DOUBLE, QPAR51	263, 408
ALTRA DICE TRACK 1 ALL., QPAR51	521
ALTRA DICE TRACK 3 ALL., QPAR51	556
ANDREAS WL, QT-DE12	373
ANELA CL, PHASE	261
ANELA PD, PHASE	306
ANGOLUX SENSOR WL	762
ANGOLUX WL	762
APONI 120 BORNE, PHASE	666
APONI 90 BORNE, PHASE	666
ARLINA 130 WL	371
ARLINA 60 WL	371
ARROCK ARC BORNE, QPAR51	648

ARROCK GRANITE 40 BORNE, CARRÉ, E27	647
ARROCK GRANITE 70 BORNE, CARRÉ, E27	647
ARROCK SLOT BORNE, QPAR51	649
ARROCK STONE 50 BORNE	649
ARROCK STONE 75 BORNE	649
ASMARA LV, QR-C51	486
ASSO 300 WL, PHASE	366, 367
ASTINA CL, QPAR51	261
ASTINA PD, QPAR51	305
ASTINA STEEL WL, QPAR51	761
ASTINA UP/DOWN WL, QPAR51	379
ASTINA WL, QPAR51	761
ASTO CW, DOUBLE, QPAR51	415
ASTO CW, QUAD, QPAR51	415
ASTO CW, SIMPLE, QPAR51	415
ASTO CW, TRIPLE, QPAR51	415
ASTO TUBE 1 ALL., GU10	505
ASTO TUBE CL, SIMPLE, GU10	395
ASTO TUBE CW, DOUBLE, GU10	397
ASTO TUBE CW, QUADRUPLE, GU10	397
ASTO TUBE CW, SIMPLE, GU10	397
ASTO TUBE CW, TRIPLE, GU10	397
ASTO TUBE RÉFLECTEUR DÉCO	285, 395, 505
ASTO TUBE PD, DOUBLE, GU 10	285
ASTO TUBE PD, QUADRUPLE, GU 10	285
ASTO TUBE PD, SIMPLE, GU 10	285
ASTO TUBE PD, TRIPLE, GU 10	285
ASTO TUBE WL, SIMPLE, GU10	347
ASTO TUBE WL, UP/DOWN, GU10	347
AVO CW, DOUBLE, QPAR51	413
AVO CW, QUAD, QPAR51	413
AVO CW, SIMPLE, QPAR51	413
AVO CW, TRIPLE, QPAR51	413
AVO TRACK 1 ALL., QPAR51	515
AVO TRACK 3 ALL., QPAR51	561

B

BASKET WL, E27	373
BATTEN 120 CW	429
BATTEN 60 CW	429
BENA 120 CW	433
BENA 150 CW	433
BIG NAILS 50 BORNE, E27	668
BIG NAILS 80 BORNE, E27	668
BIG NAUTILUS SP, ROND, QPAR51	694
BIG PLOT CACHE, 2 FENÊTRES	853
BIG PLOT CACHE, 4 FENÊTRES	853
BIG PLOT MODULE	853
BIG QUAD UP/DOWN WL	755
BIG QUAD WL	752, 755
BIG THEO CL	797
BIG THEO CL, QPAR111	797
BIG THEO UP/DOWN WL, QPAR111	735
BIG THEO WL	737
BIG THEO WL, QPAR111	737
BIMA 1 ALL., DOUBLE, QPAR51	519
BIMA 1 ALL., SIMPLE, QPAR51	519
BIMA 3 ALL., DOUBLE, QPAR51	559
BIMA 3 ALL., SIMPLE, QPAR51	559
BOOKAT BORNE	683
BOOKAT WL	751
BOX UP/DOWN WL, QT-DE12	773
BOX-L WL	773
BOX-L WL, E27	773
BRICK DOWNUNDER EL	827
BRICK DOWNUNDER EL, E14	827
BRICK EL, ASYMÉTRIQUE	825
BRICK EL, SYMÉTRIQUE	825
BRICK MESH EL	825
BULAN CW, E14	815
BULAN GRID CW, E27	815

C

C-POL BORNE, E27	672
CARISO WL, PHASE	368
CHROMBO WL, PHASE	369
COMET LED LV	491
COMET LV, QR-C51	491
CONCRETO EL, CUT	821
CONCRETO EL, WING	821
CONCRETO FL, CARRÉ, QPAR51	627
CONCRETO FL, ROND, QPAR 51	627
CONCRETO L WL	717

CONCRETO M WL	717
CONE FL, E27	660
COSMIC LV, QR-C51	487
COUPA FLEX WL	381
CUBIX FL, QPAR51	660
CYFT CW	395

D

DASAR® 115 RL, CARRÉ, QPAR51	843
DASAR® 115 RL, ROND, QPAR51	843
DASAR® 1200 EL	831
DASAR® 215 RL, CARRÉ, QPAR111	847
DASAR® 215 RL, ROND, E27	847
DASAR® 215 RL, ROND, QPAR111	846
DASAR® 255 EL	839
DASAR® 270 EL, ASYMÉTRIQUE	841
DASAR® 270 EL, SYMÉTRIQUE	841
DASAR® 370 EL, ROND	847
DASAR® 600 EL	831
DASAR® 920 EL	840
DASAR® 920 SP, 230V	698
DASAR® EXACT 116 EL, CARRÉ, QPAR51	845
DASAR® EXACT 116 EL, ROND, QPAR51	845
DASAR® FLAT 120 EL	839
DASAR® FLAT 80 EL	839
DASAR® L RL, CARRÉ	835
DASAR® L RL, ROND	835
DASAR® PROJECTOR SP, 12/24V	698
DASAR® S RL, CARRÉ	833
DASAR® S RL, ROND	833
DASAR® XL RL, CARRÉ	837
DASAR® XL RL, ROND	837
DEKLED EL	234
DELWA WL	767
DENA 30 WL, E14	373
DIO FLEX PLATE WL	387
DIO FLEX PLATE WL, QPAR51	387
DIRETO 60 WL, PHASE	370
DIRETO 90 WL, PHASE	370
DISPLAY ADL 50 QPAR51	389
DL 126 EL	227
DORISA 30 WL	339
DORISA 50 WL	339
DOWNUNDER OUT L EL	823
DOWNUNDER OUT M EL	823
DOWNUNDER OUT S EL	823
DOWNUNDER OUT WL, CARRÉ	769
DOWNUNDER OUT WL, ROND	769
DOWNUNDER PUR 150 EL	242
DOWNUNDER PUR 80 EL	242
DURNO LV	489

E

ENOLA B CL, QPAR51	259
ENOLA B CW, DOUBLE, QPAR51	407
ENOLA B CW, SIMPLE, QPAR51	407
ENOLA B PD, QPAR51	305, 517
ENOLA B TRACK 1 ALL., QPAR51	517
ENOLA B WL, QPAR51	379
ENOLA C CL	259
ENOLA C TRACK 1 ALL.	517
ENOLA C TRACK 1 ALL.	516
ENOLA C TRACK 3 ALL.	561
ENOLA M LENTILLE ASYMÉTRIQUE	731
ENOLA M LENTILLE 19°	731
ENOLA OCLUSUS CL	792
ENOLA OCLUSUS WL, SIMPLE	723
ENOLA OCLUSUS WL, UP/DOWN	723
ENOLA PD, E27	305
ENOLA ROUND L CL	793
ENOLA ROUND L WL, SIMPLE	725
ENOLA ROUND M CL	793
ENOLA ROUND M WL, SIMPLE	725
ENOLA ROUND S CL	793
ENOLA ROUND S WL, SIMPLE	725
ENOLA S, M, L, RÉFLECTEUR 56°	731
ENOLA CARRÉ L CL	795
ENOLA CARRÉ L WL, SIMPLE	729
ENOLA CARRÉ M CL	795
ENOLA CARRÉ M WL, SIMPLE	729
ENOLA CARRÉ S CL	795
ENOLA CARRÉ S WL, SIMPLE	729
ESKINA 30 BORNE	631
ESKINA 80 BORNE	631
ESKINA D DISPLAY, PHASE	783

ESKINA FRAME 125 BORNE, DOUBLE	630
ESKINA FRAME 175 BORNE, DOUBLE	630
ESKINA FRAME 45 BORNE, SIMPLE	629
ESKINA FRAME 75 BORNE, DOUBLE	629
ESKINA FRAME 75 BORNE, SIMPLE	629
ESKINA FRAME CL, SIMPLE	791
ESKINA FRAME WL	749
ESKINA FRAME WL, DOUBLE	749
ESKINA SPOT CW, PHASE	807
ESKINA SPOT SENSOR CW, PHASE	807
EURO CUBE 3 ALL.	555
EURO SPOT TRACK 1 ALL., QPAR51	521
EURO SPOT TRACK 3 ALL., QPAR111	555
EURO SPOT TRACK 3 ALL., QPAR51	555

F

F-POL BORNE, E27	672
F-POL WL, E27	778
FENDA 15 CM, ROND	448
FENDA 30 CM, ROND	449
FENDA BOW BASIS FL, E27	448
FENDA FL, E27	447, 448
FENDA Ø 45 CM, ROND	449
FENDA Ø 70 CM, ROND	449
FENDA PD, E27	296
FENDA TL, E27	447
FERA 25 CL	272
FERA 25 CL, DALI	272
FITU CUBE WL, E27	376
FITU PD, E27	295
FLAC BEAM® SP	693
FLATT 100 BORNE	679
FLATT 65 BORNE	679
FLATT SENSOR WL	760
FLATT WL	760
FLOODI L SP	691
FLOODI M SP	691
FLOODI S SP	691
FORCHINI 50 PD, E27	312
FORCHINI 70 PD, E27	312
FORCHINI M 40 PD, E27	313
FORCHINI M 40 TRACK 1 ALL., E27	512
FORCHINI M 40 TRACK 3 ALL., PD, E27	554
FORCHINI M 50 PD, E27	313
FRAME BASIC	238
FRAME BASIC RL, HV	238
FRAME BASIC SET RL	238
FRAME CURVE EL	239

G

GALEN 120 SP	692
GALEN 60 SP	692
GIMBLE OUT EL	849
GLENOS® 60 WL	339
GLENOS® PD, 1M, 1-10V	291
GLENOS® PD, 2M, 1-10V	291
GLOO PURE 27 BORNE, E27	655
GLOO PURE 44 BORNE, E27	655
GLOO PURE 70 BORNE, E27	655
GLOO PURE WL, E27	777
GRAFIT 30 BORNE, E27	637
GRAFIT 30 BORNE, ROND, E27	635
GRAFIT 60 BORNE, E27	637
GRAFIT 60 BORNE, ROND, E27	635
GRAFIT 90 BORNE, E27	637
GRAFIT 90 BORNE, ROND, E27	635
GRAFIT WL, E27	743
GRAFIT WL, CARRÉ, SENSOR, E27	743
GRAFIT WL, ROND, E27	742
GRAFIT WL, ROND, SENSOR, E27	742
GRAZIA FLEXSTRIP LED 24V	582
GRAZIA IP FLEXSTRIP 24V	591
GRAZIA IP FLEXSTRIP RGBW, 24V	591
GRAZIA IP FLEXSTRIP TUNABLE WHITE, 24V	591
GRAZIA PRO FLEXSTRIP 24V	583, 584
GRAZIA PRO FLEXSTRIP RGBW, 24V	589
GRAZIA PRO FLEXSTRIP TUNABLE WHITE, 24V	587
GRAZIA PRO MAX FLEXSTRIP 24V	585, 586
GRAZIA 10 PROFIL EN SAILLIE PLAT 2 M	567
GRAZIA 10 PROFIL EN SAILLIE STANDARD	567
GRAZIA 10 ACCESSOIRES	569
GRAZIA 10 EDGE 2 M	570

GRAZIA 10 PROFIL ENCASTRÉ	567
GRAZIA 10 EDGE ACCESSOIRES	571
GRAZIA 20 PROFIL EN SAILLIE PLAT 3 M	573
GRAZIA 20 PROFIL EN SAILLIE STANDARD 3 M	573
GRAZIA 20 PROFIL ENCASTRÉ 3 M	573
GRAZIA 20 ACCESSOIRES	574, 575
GRAZIA 60 PROFIL EN SAILLIE	577
GRAZIA 60 PROFIL ENCASTRÉ	577
GRAZIA 60 ACCESSOIRES	578, 579

H

H-POL 30 BORNE	676
H-POL 60 BORNE	676
H-POL TWIN 30 BORNE	677
H-POL TWIN 60 BORNE	677
HELIA 30 PD	301
HELIA 30 PD, PHASE	301
HELIA 40 PD	303
HELIA 40 PD, PHASE	303
HELIA 50 TRACK 1 ALL.	507
HELIA 50 TRACK 3 ALL.	561
HELIA AMBIENT 35 PD	300
HELIA AMBIENT 35 PD, PHASE	300
HELIA CW, DOUBLE, PHASE	809
HELIA CW, SIMPLE, PHASE	809
HELIA SPOT L SP, SIMPLE, PHASE	699
HELIA SPOT S SP, SIMPLE	699
HORN DL, DOUBLE, QPAR51	219
HORN DL, SIMPLE, QPAR51	219, 220
HORN EL, SIMPLE, QPAR51	220
HORN MAGNA EL	221
HORN MINI EL	218
HORN-T EL, QPAR111	221

I

I-PENDANT PRO PD, 1195X295MM, DALI	289
I-RING BORNE	613
I-RING WL	714
IMPERVA 120 CW	817
IN-LINE 22 48V,	
DARKLIGHT REFLECTOR, DALI	473
IN-LINE 22 48V, OPAL, DALI	473
IN-LINE 24 48V, MOVE, OPAL, DALI	477
IN-LINE 44 48V,	
DARKLIGHT REFLECTOR, DALI	475
IN-LINE 44 48V, OPAL, DALI	475
IN-LINE 46 48V, MOVE,	
DARKLIGHT REFLECTOR, DALI	477
INDA CW, QPAR51	409
IPERI 50 BORNE	681
IPERI WL	780

K

KADUX DL, DOUBLE, PHASE	213
KADUX DL, SIMPLE, PHASE	213
KADUX DL, TRIPLE, PHASE	213
KADUX EL, DOUBLE, QPAR111	215
KADUX EL, DOUBLE, QPAR51	214
KADUX EL, SIMPLE, QPAR111	215
KADUX EL, SIMPLE, QPAR51	214
KADUX EL, TRIPLE, QPAR51	214
KALU CW, DOUBLE, PHASE	403
KALU CW, DOUBLE, QPAR111	405
KALU CW, QUAD, PHASE	403
KALU CW, QUAD, QPAR111	405
KALU CW, SIMPLE, PHASE	403
KALU CW, SIMPLE, QPAR111	405
KALU CW, TRIPLE, PHASE	403
KALU CW, TRIPLE, QPAR111	405
KALU TRACK 1 ALL., PHASE	520
KALU TRACK 1 ALL., QPAR111	520
KALU TRACK 3 ALL., QPAR111	558
KALU TRACK LED 3 ALL., PHASE	558
KARPO 30 CW, SIMPLE	399
KARPO 30 EL	232
KARPO 30 WL, SIMPLE	383
KARPO FL	452
KARPO GOOSE WL	382
KARPO MAGN CW, SIMPLE, PHASE	382
KARPO TL	452
KARPO WL	383
KENKUA SPOT WL, E27	381
KERAS ELT WL, E27	779
KINI EL, PHASE	237

L			
L-LINE 120 WL	341	MANA OUT WL, SET	721
L-LINE 60 WL	341	MARONA CL, PHASE	273
L-LINE OUT 30 FL, VERTICAL	650	MARYLIN 40/60/90 WL	333
L-LINE OUT 50 BORNE, HORIZONTAL	651	MEDO® 30 CW, PHASE	161
L-LINE OUT 60 FL, VERTICAL	651	MEDO® 30 EL, CADRE DE MONTAGE	171
L-LINE OUT 80 BORNE, HORIZONTAL	651	MEDO® 30 EL, SANS CADRE	170
L-LINE OUT WL	775	MEDO® 40 CW, PHASE	161
LALU® CONE 15 ABAT-JOUR	178	MEDO® 40 EL, CADRE DE MONTAGE	171
LALU® ELYPSE 15 ABAT-JOUR	178	MEDO® 40 EL, SANS CADRE	170
LALU® ELYPSE 22 ABAT-JOUR	178	MEDO® 60 CL, CARRÉ, 1-10V	165
LALU® ELYPSE 33 ABAT-JOUR	178	MEDO® 60 CL, CARRÉ, DALI	165
LALU® PD, E27	183	MEDO® 60 CW, PHASE	161
LALU® PD, LED BASE, PHASE	177	MEDO® 60 EL, CADRE DE MONTAGE	171
LALU® PD, LED BASE, PHASE, ENCASTRÉ	177	MEDO® 60 EL, SANS CADRE	170
LALU® PLATE 15 ABAT-JOUR	178	MEDO® 90 CL, PHASE	161
LALU® PLATE 22 ABAT-JOUR	178	MEDO® PRO 30 CW, DALI	152
LALU® SHADE, E27 BASE	183	MEDO® PRO 30 CW, DALI, UGR<19	150
LALU® TETRA 14 ABAT-JOUR	178	MEDO® PRO 30 CW, DALI, UGR<19, DC	157
LALU® TETRA 24 ABAT-JOUR	178	MEDO® PRO 30 CW, PHASE	152
LALU® TETRA 36 ABAT-JOUR	178	MEDO® PRO 30 CW, PHASE, UGR<19	150
LED PANEL 620X620MM	243	MEDO® PRO 40 CW, DALI	152
LED SPIKE SP	701	MEDO® PRO 40 CW, DALI, UGR<19	150
LED SPOT SP	785	MEDO® PRO 40 CW, DALI, UGR<19, DC	157
LID I 45 BORNE, SIMPLE	611	MEDO® PRO 40 CW, PHASE	152
LID I 75 BORNE, DOUBLE	611	MEDO® PRO 40 CW, PHASE, UGR<19	150
LID I WL, DOUBLE	713	MEDO® PRO 40 CW, DALI	152
LID I WL, SIMPLE	713	MEDO® PRO 40 CW, DALI, UGR<19	150
LID II WL	711	MEDO® PRO 40 CW, DALI, UGR<19, DC	157
LID II WL, UP/DOWN	711	MEDO® PRO 40 CW, PHASE	152
LIGHT EYE® 150 1 ALL., PD, QPAR111	511	MEDO® PRO 60 CW, DALI, UGR<19	151
LIGHT EYE® 150 PD, QPAR111	314	MEDO® PRO 60 CW, DALI, UGR<19, DC	157
LIGHT EYE® 90 1 ALL., QPAR51	511	MEDO® PRO 60 CW, PHASE	153
LIGHT EYE® 90 PD, GU10	314	MEDO® PRO 60 CW, PHASE, UGR<19	151
LIPSY® 30 CW, DOME	423	MEDO® PRO 90 CL, DALI	153
LIPSY® 30 CW, DRUM	425	MEDO® PRO 90 CL, DALI, UGR<19	151
LIPSY® 40 CW, DOME	423	MEDO® PRO 90 CL, DALI, UGR<19, DC	157
LIPSY® 40 CW, DRUM	425	MEDO® PRO 90 CL, PHASE	153
LIPSY® 40 CW, DRUM, DALI	426	MEDO® PRO 90 CL, PHASE, UGR<19	151
LIPSY® 50 CW, DOME	423	MEDO® RING 60 PD, 1-10V	167
LIPSY® 50 CW, DRUM	425	MEDO® RING 60 PD, DALI	167
LIPSY® 50 CW, DRUM, DALI	426	MEDO® RING 90 PD, 1-10V	167
LISENNE 40 BORNE, E27	662	MELAN CW, E27	427
LISENNE 70 BORNE, E27	662	MERADO FLOOD WL, PHASE	388
LISENNE PD, E27	306	MERIDIAN BOX SENSOR WL, E27	747
LISENNE WL, E27	375	MERIDIAN BOX WL, E27	746, 747
LITTLE SUN TL	443	MERIDIAN WL, E27	746
LOGS 40 BORNE	633	MIBO UP/DOWN WL, QT14	337
LOGS 70 BORNE	633	MILANDOS 4 DL	217
LOGS IN L WL, PHASE	363	MILANDOS 6 DL	217
LOGS IN WL	362	MILANDOS 8 DL	217
LOGS IN WL, PHASE	362	MOBALA EL	243
LOGS WL	775	MOLAT CL, E27	799
LONG GRILL CW	430	MOLAT PD, E27	661
LYGANT WL, DOUBLE	325	MOLAT BORNE, E27	661
LYGANT WL, SIMPLE	325	MOLAT WL, E27	777
		MYRA CW, SIMPLE, QPAR51	785
		MYRA DISPLAY WL, COURBE, QPAR51	783
		MYRA SPOT DOUBLE, GU10	685
		MYRA UP/DOWN WL, QPAR51	764
		MYRA WL, DOUBLE, QPAR51	811
		NAGY 75 CL, QPAR51	261
M			
M-POL 30 BORNE	623	N	
M-POL 60 BORNE	623	NAUTILUS 10 SP, CARRÉ	696
M-POL 90 BORNE	623	NAUTILUS 10 SP, ROND, QPAR51	694, 695
M-POL M TÊTE DE LAMPE	619	NAUTILUS 10 SPOT LED SP	697
M-POL M TÊTE DE LAMPE, DALI	619	NAUTILUS 10 SPOT SP, QPAR51	697
M-POL M TÊTE DE LAMPE, LOUVER	621	NAUTILUS SP, QR-C51	697
M-POL M TÊTE DE LAMPE, LOUVER, DALI	621	NAUTILUS WL QPAR51	785
M-POL M TÊTE DE LAMPE, SHADER	620	NEW TRIA® 150 DL, CARRÉ, QPAR111	145
M-POL M TÊTE DE LAMPE, SHADER, DALI	620	NEW TRIA® 150 DL, ROND, QPAR111	145
M-POL S TÊTE DE LAMPE	616	NEW TRIA® 155 DL, DOUBLE	141
M-POL S TÊTE DE LAMPE 180°, ANTI-ÉBLOUISSEMENT	615	NEW TRIA® 155 DL, DOUBLE, QPAR51	145
M-POL S TÊTE DE LAMPE 180°, ANTI-ÉBLOUISSEMENT, DALI	615	NEW TRIA® 300 DL, DOUBLE, QPAR111	145
M-POL S TÊTE DE LAMPE 360°, ANTI-ÉBLOUISSEMENT	614	NEW TRIA® 45 DL, ROND	141
M-POL S TÊTE DE LAMPE 360°, ANTI-ÉBLOUISSEMENT, DALI	614	NEW TRIA® 68 DL, CARRÉ, DTW, PHASE	135
M-POL S TÊTE DE LAMPE, DALI	617	NEW TRIA® 68 DL, CARRÉ, PHASE	134
M-POL S TÊTE DE LAMPE, LOUVER	618	NEW TRIA® 68 DL, CARRÉ, QPAR51	138
M-POL S TÊTE DE LAMPE, LOUVER, DALI	618	NEW TRIA® 68 DL, ROND, DTW, PHASE	135
M-POL S TÊTE DE LAMPE, SHADER	617	NEW TRIA® 68 DL, ROND, PHASE	134, 135
M-POL S TÊTE DE LAMPE, SHADER, DALI	617	NEW TRIA® 68 DL, ROND, QPAR51	138
MAGANDA TL	453	NEW TRIA® 75 DL, CARRÉ, QPAR51	138
MAGANDA WL	337	NEW TRIA® 75 DL, ROND, PHASE	137
MANA BASE WL, ROND, PHASE	720	NEW TRIA® 75 DL, ROND, QPAR51	138
MANA OUT WL, PHASE	721	NEW TRIA® 75 XL DL, CARRÉ, QPAR51	139
		NEW TRIA® 75 XL DL, ROND, QPAR51	139
		NEW TRIA® UNIVERSAL 68 DL, CARRÉ, PHASE	136, 137
		NEW TRIA® UNIVERSAL 68 DL, ROND, PHASE	136, 137
		NOBLO® CW, DOUBLE, PHASE	401
		NOBLO® CW, SIMPLE, PHASE	401
		NOBLO® CW, TRIPLE, PHASE	401
		NOBLO® SPOT LV, ROPE TRACK	491
		NOBLO® SPOT 1 ALL., PHASE	501, 503
		NOBLO® SPOT 1 ALL., TRIPLE TRACK SET	501
		NOBLO® SPOT 3 ALL., PHASE	545, 547
		NOTAPO L RL	241
		NOTAPO S RL	241
		NOYA PD, PHASE	290
		NUMINOS® 3 PH.	110-113
		NUMINOS® CL	103-105
		NUMINOS® CW	99-101
		NUMINOS® DL	83-85
		NUMINOS® GIMBLE DL	88-89
		NUMINOS® MOVE DL	86-87
		NUMINOS® PD	106-109
		NUMINOS® PROJECTOR DL	91-93
		NUMINOS® S SUSPENSION 48V, DALI	471
		NUMINOS® S SPOT 48V, DALI	469
		NUMINOS® XS SUSPENSION 48V, DALI	471
		NUMINOS® XS SPOT 48V, DALI	469
		NUMINOS® ZOOM SYSTÈME TRACK 3 ALLUMAGES	115
		NUMINOS® ACCESSOIRES	94-95
		O	
		OCCLUDAS 13 CL, INDIRECT, PHASE	262
		OCCLUDAS 23 CL, INDIRECT, PHASE	262
		OCULUS CL, MOVE, PHASE	229
		OCULUS CL, PHASE	258
		OCULUS CW, PHASE	399
		OCULUS PD, SIMPLE, PHASE	294
		OCULUS UP/DOWN WL, PHASE	355
		OCULUS WL, SIMPLE, PHASE	355
		ONE® 40 CW, DALI	193
		ONE® 60 CW, DALI	193
		ONE® 60 PD, DALI	188
		ONE® 60 PD, UP/DOWN, DALI	188
		ONE® 60 PD, UP/DOWN, PHASE	188
		ONE® 80 PD, DALI	188
		ONE® 80 PD, UP/DOWN, DALI	188
		ONE® BOW FL, UP/DOWN	197
		ONE® CUBE PD, DALI	189
		ONE® CUBE PD, UP/DOWN, DALI	189
		ONE® DOUBLE PD, UP/DOWN, DALI	189
		ONE® DOUBLE PD, UP/DOWN, PHASE	189
		ONE® LINEAR 100 PD, UP/DOWN, PHASE	191
		ONE® LINEAR 140 PD, UP/DOWN, PHASE	191
		ONE® STRAIGHT FL, UP/DOWN	196
		ONE® TRIPLE PD, DALI	189
		ORDI SENSOR WL	771
		ORDI WL	771
		OSSA 180 WL, QT-DE12	367
		OSSA 300 WL, QT-DE12	367
		OTOS GLAS BORNE, E27	659
		OUT-BEAM FRAME SP	811
		OVAL 14 WL, UP/DOWN	715
		OVAL 18 WL, UP/DOWN	715
		OVALISK 100 BORNE	653
		OVALISK 75 BORNE	653
		OVALISK CL	797
		OVALISK SENSOR WL	757
		OVALISK WL	757
		P	
		PANEL CL, 1200X300MM, DALI	275
		PANEL CL, 1200X300MM, PHASE	275
		PANEL TRACK 1 ALL., RECTANGULAIRE	507
		PANEL TRACK 1 ALL., ROND	507
		PANTILO 20 PD, E27	281
		PANTILO 28 PD, E27	281
		PANTILO CONVEX 29 PD, E27	283
		PANTILO CONVEX 40 PD, E27	283
		PANTILO OVAL PD, E27	281
		PANTILO ROPE 19 CW, E27	393
		PANTILO ROPE 19 PD, E27	279, 505, 549
		PANTILO ROPE 20 PD, E27	279
		PANTILO ROPE 27 CW, E27	393
		PANTILO ROPE 27 PD, E27	279
		PANTILO ROPE WL, G9	345
		PANA 380 PD, E27	319
		PANA CONE 14 1 ALL., PD, QPAR51	509

PARA CONE 14 1 ALL., QPAR51	509
PARA CONE 14 3 ALL., PD, QPAR51	553
PARA CONE 14 3 ALL., QPAR51	553
PARA CONE 20 PD, E27	309
PARA CONE 30 PD, E27	309
PARA CONE GL 1 ALL., GU10	508
PARA CONE GL 3 ALL., GU10	552
PARA CONE GL PD, GU10	309, 508, 552
PARA DOME PD, E27	318
PARA DOME ABAT-JOUR	318
PATTA-I EL, ROND, PHASE	244, 245
PATTA-I EL, CARRÉ, PHASE	244, 245
PATTA-F EL, ROND, PHASE	246
PATTA-F EL, CARRÉ, PHASE	247
PEMA® WL	758, 759
PEMA® WL, E27	759
PHELIA 10 PD, E27	310
PHELIA 20 PD, E27	311
PHELIA 25 PD, E27	311
PHELIA 30 PD, E27	311
PHELIA FL, E27	453
PHELIA WL, QPAR51	388
PHOTONI 45 BORNE, E27	605
PHOTONI 75 BORNE, E27	605
PHOTONI CL, E27	789
PHOTONI WL, E27	709
PHOTONIA CL, E27	799
PHOTONIA PD, E27	659
PHOTONIA BORNE, E27	659
PHOTONIA WL, E27	777
PLASTRA 101 WL, E14	361
PLASTRA 104 CL, E27	271
PLASTRA 104 WL, QT14	361
PLASTRA 105 CL, E27	271
PLASTRA CL, PHASE	271
PLASTRA CL, QPAR51	270
PLASTRA WL, CUBE, QT14	356
PLASTRA WL, CUBES	356
PLASTRA WL, CURVE, QT-DE12	361
PLASTRA WL, E14	357
PLASTRA WL, QPAR51	360
PLYTTA LV	490
POWER TRAIL-LITE® EL, CARRÉ	849
POWER TRAIL-LITE® EL, ROND	849
PURI CW, DOUBLE, QPAR51	411
PURI CW, QUAD, QPAR51	411
PURI CW, SIMPLE, QPAR51	411
PURI CW, TRIPLE, QPAR51	411
PURI TRACK 1 ALL., QPAR51	513
PURI TRACK 1 ALL., TRIPLE TRACK SET	513
PURI TRACK 3 ALL., QPAR51	557
PURI TRACK GLASS 3 ALL., QPAR51	557
PURIA TRACK 1 ALL., QPAR51	515
Q	
Q-LINE® CL, 1M, BAP, PHASE	253
Q-LINE® CL, 2M, BAP, PHASE	253
Q-LINE® PD, 1M, BAP, PHASE	293
Q-LINE® PD, 2M, BAP, PHASE	293
Q-LINE® PD, DALI, SIMPLE	293
Q-LINE® WL	341
QUAD FRAME 14 WL	364
QUAD FRAME 19 WL	364
QUAD FRAME 9 WL	240
QUAD BORNE	683
QUAD UP/DOWN 15 WL	753
QUAD WL	752
QUADRASS PD, E27	307
QUADRASS SPOT WL, E27	375
QUADRASS WL, E27	375
QUADRASYL 75 BORNE, TCR-TSE	682
QUADRASYL WL, TCR-TSE	781
QUADRULO CL	811
QUADRULO FL	639
QUADRULO SENSOR WL, E27	745
QUADRULO WL	744
QUADRULO WL, E27	745
R	
R-CUBE 35 BORNE	609
R-CUBE 75 BORNE	609
R-CUBE CW	805
RASCALI 45 BORNE	684
RASCALI 65 BORNE	684
RASCALI WL	780

ROCCI 200 EL, CARRÉ	855
ROCCI 200 EL, ROND	855
ROCCI EL, CARRÉ	854
ROCCI EL, ROND	854
ROTOBALL 25 FL, E27	657
ROTOBALL 25 PD, E27	317
ROTOBALL 40 FL, E27	657
ROTOBALL 40 PD, E27	317
ROTOBALL 50 FL, E27	657
ROTOBALL 50 PD, E27	317
ROX ACRYL 30 BORNE, E27	669
ROX ACRYL 60 BORNE, E27	669
ROX ACRYL 90 BORNE, E27	669
ROX CL, GX53	801
ROX CL, QPAR111	801
ROX UP/DOWN WL, QPAR111	767
ROX WL, QPAR111	767
RUBA CW	814
RUSTY® 40 BORNE	642
RUSTY® 40 BORNE, E27	643, 646
RUSTY® 70 BORNE	643
RUSTY® 70 BORNE, E27	643, 646
RUSTY® CONE 24 FL, E14	645
RUSTY® CONE 40 BORNE, E27	645
RUSTY® CONE 70 BORNE, E27	645
RUSTY® MANA ABAT-JOUR, CARRÉ	720
RUSTY® MANA ABAT-JOUR, ROND	720
RUSTY® PATHLIGHT BORNE, TCR-TSE	642
RUSTY® SLOT 50 BORNE	640
RUSTY® SLOT 50 BORNE, E27	641
RUSTY® SLOT 80 BORNE	640
RUSTY® SLOT 80 BORNE, E27	641
RUSTY® UP/DOWN WL, CARRÉ	756
RUSTY® UP/DOWN WL, ROND	756
S	
S-CUBE 35 BORNE	607
S-CUBE 75 BORNE	607
S-CUBE CL	791
S-CUBE CW	805
S-TUBE 32 BORNE, GU10	603
S-TUBE 75 BORNE, GU10	603
S-TUBE CW	805
SALUNA LV, QR-C51	489
SAMRINA SP, SIMPLE, GU10	693
SEDO 14 WL	329
SEDO 21 WL	329
SEDO 7 WL	329
SHELL 15 WL, PHASE	365
SHELL 30 WL, PHASE	365
SIGHT 115 CW	431
SIGHT 60 CW	431
SIGHT MOVE 3 ALL.	551
SIGHT MOVE 3 ALL., DALI	551
SIGHT TRACK 3 ALL.	550
SIGHT TRACK 3 ALL., DALI	550
SITRA 360 CW, TCR-TSE	808
SITRA 360 BORNE, TCR-TSE	685
SITRA 360 SPIKE SP, DOUBLE, TCR-TSE	703
SITRA 360 SPIKE SP, SIMPLE, TCR-TSE	703
SITRA CL, TCR-TSE	801
SITRA CUBE WL, TCR-TSE	741
SITRA L WL, UP/DOWN, RECTANGULAIRE	741
SITRA M WL, UP/DOWN, RECTANGULAIRE	741
SITRA S WL, SIMPLE, RECTANGULAIRE	739
SITRA UP/DOWN WL	765
SITRA UP/DOWN WL, TCR-TSE	765
SITRA WL, TCR-TSE	779
SLOTBOX 40 BORNE	678
SLOTBOX 70 BORNE	678
SLOTS 45 BORNE	675
SLOTS 65 BORNE	675
SLOTS WL	768
SMALL PLOT CACHE, 2 FENÊTRES	851
SMALL PLOT CACHE, 4 FENÊTRES	851
SMALL PLOT MODULE	851
SOLASTO EL, CARRÉ	857
SOLASTO EL, ROND	857
SOLID CUBE WL, QT14	377
SOPRANA CL, E27	269
SOURCES	
LED A60 E27	864
LED A60 E27	864
LED A60 E27	864

LED A60 E27, TÊTE MIROIR, CHROM	865
LED A60 E27, RGBW, SMART	864
LED A60 E27, TUNABLE 2700-6500K, SMART	864
LED C35 E14	860
LED C35 E14	860
LED G125 E27	865
LED GU10	862
LED GU10	862
LED GU10	862
LED QPAR 111 GU10	863
LED QPAR 111 GU10	863
LED QPAR 111 GU10	863
LED QPAR111 GU10	862
LED QPAR111 GU10	863
LED QPAR111 GU10	863
LED QPAR111 GU10	864
LED QPAR51 GU10	861
LED QPAR51 GU10	862
LED QPAR51 GU10, RGBW, SMART	861
LED QPAR51 GU10, TUNABLE 2700-6500K, SMART	861
LED QR51 GU5.3	861
LED QT14 G9	860
LED QT-DE12 R7S, 118 MM	860
LED QT-DE12 R7S, 78 MM	860
LED ST58 E27	865
LED ST64 E27	865
LED T32 GU10	861
LED T38 E27	865
LED T45 E27	865
LED TCR-TSE GX53	860
QPAR111 GU10, RGBW, SMART	862
QPAR111 GU10, RGBW, SMART	862
QPAR111 GU10, TUNABLE 2700-6500K, SMART	863
SPOT 79 CW, QPAR51	409
CARRÉ BORNE 30 BORNE, E27	673
CARRÉ BORNE 60 BORNE, E27	673
CARRÉ BORNE 90 BORNE, E27	673
CARRÉ TURN WL, G9	781
CARRÉ WL, E27	779
SUN / BIG SUN PD, E27	315
SYNA GARDEN SP	689
SYNA PLANT SP	689
SYNA SP	689
SYROS LV, QR-C51	489
T	
TAHA KIT DE LUMINAIRES, SANS FIL	441, 601
TELESKOP LV, QR-C51	486
TENORA CL, E27	268
TENSEO CÂBLE TENDU T.B.T.	482-484
TENSEO CÂBLE TENDU T.B.T. ACCESSOIRES	485
TERANG 200 CW	817
THEO BRACKET CW	808
THEO BRACKET SP	701
THEO PATHLIGHT BORNE, DOUBLE	652
THEO UP/DOWN WL, QPAR51	377, 735
THEO WL, QPAR51	736
TINY SUN TL	443
TODAY PRO DISPLAY	783
TONGA® 1 ALL., PD, E14	511
TONGA® PD, E14	307
TONILA TL	453, 601
TRAIL-LITE® 60 EL	848
TRUKKO 60 WL	332
TRUKKO 90 WL	332
TRUST 30 BORNE	667
TRUST 60 BORNE	667
TS V 3 ALL.	543
U	
UNIVERSAL DOWNLIGHT DL	
WITH COVER, MULTIPACK	208, 209
UNIVERSAL DOWNLIGHT DL,	
MOVE, PHASE	207
UNIVERSAL DOWNLIGHT DL, PHASE	205
V	
VANO WING SP, DALI	719
VAP SLIM 30 BORNE, E27	671
VAP SLIM 60 BORNE, E27	671
VAP SLIM 90 BORNE, E27	671
VARU EL, QPAR51	234

VARYT CL, E14	251
VARYT TL, E14	443
VARYT WL, E14	327
VILUA L WL	763
VILUA S WL	763
VILUA UP/DOWN, WL	763
VINOLINA ONE TL, SANS FIL	437, 597
VINOLINA TL, SANS FIL	437, 597
VINOLINA TWO TL, SANS FIL	439, 599

W

WALLYX WL, QPAR51	768
WL 106 E14	335
WL 149 WL, PHASE	334
WL 149 WL, QT-DE12	334
WORKLIGHT FL	445
WORKLIGHT PD, DALI	288
WORKLIGHT PRO 120 PD, DALI	287
WORKLIGHT PRO 150 PD, DALI	287
WORKLIGHT PRO FL, DOUBLE	444
WORKLIGHT PRO FL, SIMPLE	444
WORKLIGHT TL	445
WORO EL	243

SIGNIFICATION DES SYMBOLES



Recommandations

Indique les accessoires et sources recommandées pour les produits concernés



Longueur du câble secteur en cm
Longueur du câble d'alimentation en cm (câble nu)

MIX
match

Mix & Match

Indique les produits personnalisables par combinaison



Forme de la découpe d'installation



Classe d'efficacité énergétique

« Cette lampe contient une source de classes d'efficacité énergétique (CEE) ... »



Profondeur d'encastrement

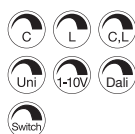

VARIABLE AVEC :

- **C** = Variateur à coupure de phase descendante
- **L** = Variateur à coupure de phase ascendante
- **Uni** = Variateur universel
- **1-10 V**
- **Dali** = Système de gestion DALI
- **Switch** = Interrupteur/bouton ou commande tactile sur le luminaire



Résistance du produit au passage de véhicules



Résistance au poids du produit jusqu'à la valeur indiquée en tonnes. Les mesures se basent sur un encastrement dans le béton.



Autorise le montage d'un appareil électrique sur des matériaux dont l'inflammabilité n'est pas connue.



Classes de protection

- Classe de protection I / Conducteur de protection
- Classe de protection II / Isolation double ou renforcée
- Classe III / Fonctionnement basse tension



Câblage continu possible



Indice de protection IP :

Indique la compatibilité des équipements électriques avec différentes conditions environnementales.



Convertisseur indépendant : peut être utilisé en dehors des luminaires



Indice de résistance IK :

L'indice de protection contre les chocs IK mesure le degré de résistance des boîtiers des équipements électriques aux sollicitations mécaniques, notamment aux chocs.



Unité de commande de sécurité résistante aux court-circuits



Utilisation uniquement en intérieur. Inadapté pour une utilisation en extérieur.



Angle de rayonnement :

décrit l'angle du faisceau lumineux en degrés. Plus la valeur de l'angle est faible, plus la concentration de la lumière est élevée.



Connected Lighting :
Indique les produits intelligents utilisant les protocoles suivants :
• Zigbee®
• DALI
• Bluetooth



Orientation et inclinaison en degrés :

- Plage d'orientation
- Plage d'inclinaison
- Dispositif à cardan



Interrupteur CCT :

Le luminaire offre la possibilité de sélectionner une température de couleur de 2700K, 3000K, 4000K ou 6500 K lors de l'installation, à l'aide d'un interrupteur CCT intégré.

UGR

Unified Glare Rating :

Plus la valeur UGR est faible, moins la sensation psychologique d'éblouissement sera forte.



Indique les lampes RVB+B et RVB (Rouge-vert-bleu + blanc et rouge-vert-bleu)



Durée de vie en heure

Facteur de conservation :

Indique le pourcentage du flux lumineux d'une LED perdu dans un intervalle de temps donné.



Dim-to-Warm:

La variation modifie la température de couleur du blanc froid au blanc chaud.



Longueur du câble de suspension en cm



- Produits avec LED intégrées
- Produits avec douille

Une grande partie des produits présentés dans ce catalogue est protégée par des marques, des modèles déposés ou enregistrés ou des brevets. Toute violation de ces droits de propriété ou toute utilisation de texte, de mise en page ainsi que d'images protégées par des droits d'auteur sans notre consentement fera l'objet de poursuites. Les illustrations et informations contenues dans ce catalogue sont fournies à titre d'exemple uniquement et ne sont pas contraignantes en termes de couleur, de forme, de conception et de caractéristiques techniques. Toutes les descriptions et spécifications des produits sont donc sujettes à des changements et des erreurs. Tous les produits de notre gamme sont soumis à des contrôles d'assurance qualité rigoureux et répondent aux normes en vigueur. Ce catalogue présente un assortiment général et n'est pas spécifique à un pays. Toute divergence par rapport aux exigences propres à chaque pays doit être clarifiée avant la commande. SLV décline toute responsabilité en cas de normes techniques divergentes. Sauf indication contraire, toutes les valeurs de poids et de longueur sont indiquées en kg et en cm. Sous réserve de modifications techniques !

La présentation de nos luminaires avec des illustrations photographiques réalistes est rendue possible par l'aimable volonté et le consentement des propriétaires ou des concepteurs des environnements représentés. Nous aimerions profiter de cette occasion pour remercier une nouvelle fois tous ceux qui ont contribué à la réalisation de ces photos et en ont accepté la diffusion !

La publication de ce catalogue invalide les tarifs des listes et catalogues précédents. SLV est en droit d'adapter chaque liste de prix en fonction des fluctuations du marché, en cas de changements importants des coûts d'approvisionnement, de modifications de la TVA ou des prix d'achat.

Tous les tarifs indiqués sont des prix de vente conseillés en CHF hors TVA.

Éditeur
SLV GmbH, Allemagne
Daimlerstraße 21-23
52531 Übach-Palenberg
T +49 (0) 2451 4833-0
slv.com

Copyright
© SLV GmbH, 2023



SLV GmbH | Daimlerstraße 21-23, 52531 Uebach-Palenberg, Germany, +49 (0) 2451 4833-333, info@slv.de
SLV Austria | +49 (2451) 4833 355, export@slv.de
SLV Belgium | Herentalsebaan 429, B-2160 Wommelgem, +32 (0) 3/385 30 08, info@slv.be
SLV Nordics | Flade Engvej 4, 9900 Frederikshavn, Denmark, +45 9310 7474, info@nordics.slv.com
SLV France | Zac du Martelet, 88, rue Henri Dépaigneux, F-69400 Limas, +33 4 74 02 71 20, infofr@slv.com
SLV LIGHTING UK LTD | Unit E Chiltern Park, Boscombe Road, Dunstable, LU5 5LT, +44 (0)203 968 11 00, sales@uk.slv.com
SLV Italia S.r.l. | Via Lecco, 19/D, 23896 Bevera di Sirtori (LC), +39 039 5983575, infoit@slv.com
SLV Nederland | Kazernestraat 19, 5928 NL Venlo, +31 773204343, info@slv.nl
SLV i Norge, del av SLV Nordics | Tors veg 9B, 7035 Trondheim, +47 4777 1080, post-no@slv.com
SLV Poland | +48 (22) 7224975, slv@slv.pl
SLV Portugal | R. Margarida de Abreu, no13 – Lj2, 1900-314 Lisboa, +351 210 185 961, info@pt.slv.com
SLV Swiss SA | Route du Bey 6 Box 1-4, Z.I. La Jonnaire, CH-1847 Rennaz, +41 218113232, info@slv-swiss.ch
SLV d.o.o | Barjanska cesta 50, SI-1000 Ljubljana, +386 1 2009 730, info@slv.si
SLV Spain | Antic Cami Real Valencia, 38, L17, 08860 Castelldefels, Barcelona, 931 168 161, info@slv.es
SLV Czech s.r.o. | V Sedlci 28/17, CZ-160 00 Praha 6, +420 739 282 151, info@cz.slv.com